



US00D953658S

(12) **United States Design Patent**
Huang

(10) **Patent No.:** **US D953,658 S**

(45) **Date of Patent:** **** May 31, 2022**

(54) **CAT SCRATCHING PAD**

(71) Applicant: **Shenzhen zhongdaxin Epoxy plate Co. Ltd., Shenzhen (CN)**

(72) Inventor: **Shengwen Huang, Anxiang (CN)**

(**) Term: **15 Years**

(21) Appl. No.: **29/733,152**

(22) Filed: **Apr. 30, 2020**

(51) **LOC (13) Cl.** **30-99**

(52) **U.S. Cl.**
USPC **D30/158**

(58) **Field of Classification Search**
USPC D30/160, 112, 119, 158; D1/125-127, D1/120; D28/7, 59; D4/137; D32/35, D32/40, 43, 50
CPC A46B 2200/1093; B08B 1/00; B08B 1/005
See application file for complete search history.

(56) **References Cited**

U.S. PATENT DOCUMENTS

D49,710 S *	9/1916	Lupo	D28/59
D170,035 S *	7/1953	Troya	D28/59
D456,098 S *	4/2002	Fracassi	D28/59
D513,093 S *	12/2005	Kim	D28/59
D555,843 S *	11/2007	Lika	D30/160
D559,461 S *	1/2008	Garland	D28/59
D663,491 S *	7/2012	Haaf	D30/160
D665,138 S *	8/2012	Haaf	D30/160
D672,919 S *	12/2012	Campbell	D28/44.1
8,578,890 B1 *	11/2013	Haaf	A01K 15/024 119/706
D730,574 S *	5/2015	Long	D28/7
D782,750 S *	3/2017	Denney	D30/158

9,737,045 B1 *	8/2017	Scanlan	A01K 1/011
D816,922 S *	5/2018	Long, Jr.	D30/160
2008/0149041 A1 *	6/2008	Lamstein	A01K 15/024 119/706
2010/0050953 A1 *	3/2010	Fails, Jr.	A01K 15/024 119/706
2014/0261223 A1 *	9/2014	Gee	A01K 13/004 119/621
2017/0172108 A1 *	6/2017	Long, Jr.	A01K 15/024

OTHER PUBLICATIONS

Waretary, posted at amazon.com, earliest date available Mar. 9, 2020, [online], acquired on Mar. 9, 2022, Available on internet, url: <https://www.amazon.com/-/es/Waretary-Rascador-almohadilla-antideslizante-resistente/dp/B085NNTBC2> (Year: 2020).*

* cited by examiner

Primary Examiner — Sheryl Lane
Assistant Examiner — Aula Soroush

(57) **CLAIM**

The ornamental design for a cat scratching pad, as shown and described.

DESCRIPTION

FIG. 1 is a perspective view of a cat scratching pad showing my new design;
FIG. 2 is a front view thereof;
FIG. 3 is a back view thereof;
FIG. 4 is a left side view thereof;
FIG. 5 is a right side view thereof;
FIG. 6 is a top view thereof;
FIG. 7 is a bottom view thereof; and,
FIG. 8 is an enlarged view of the selected portion in FIG. 1.

1 Claim, 8 Drawing Sheets

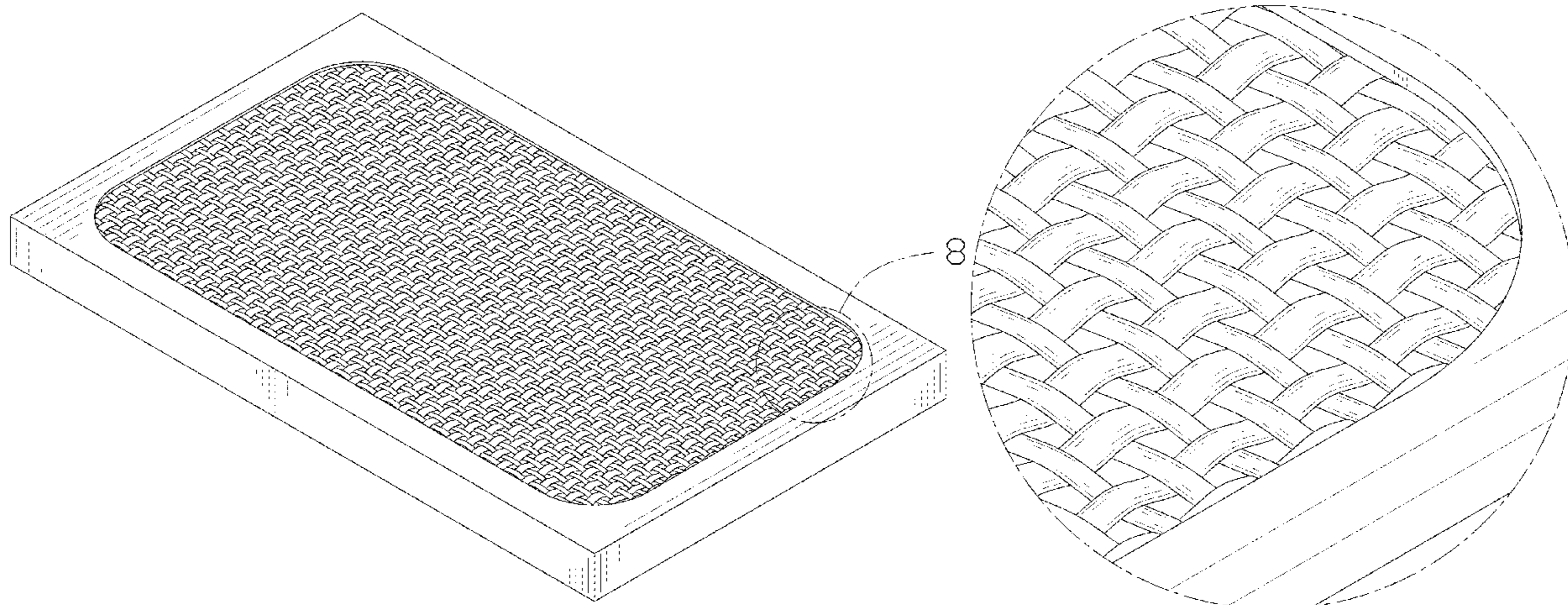

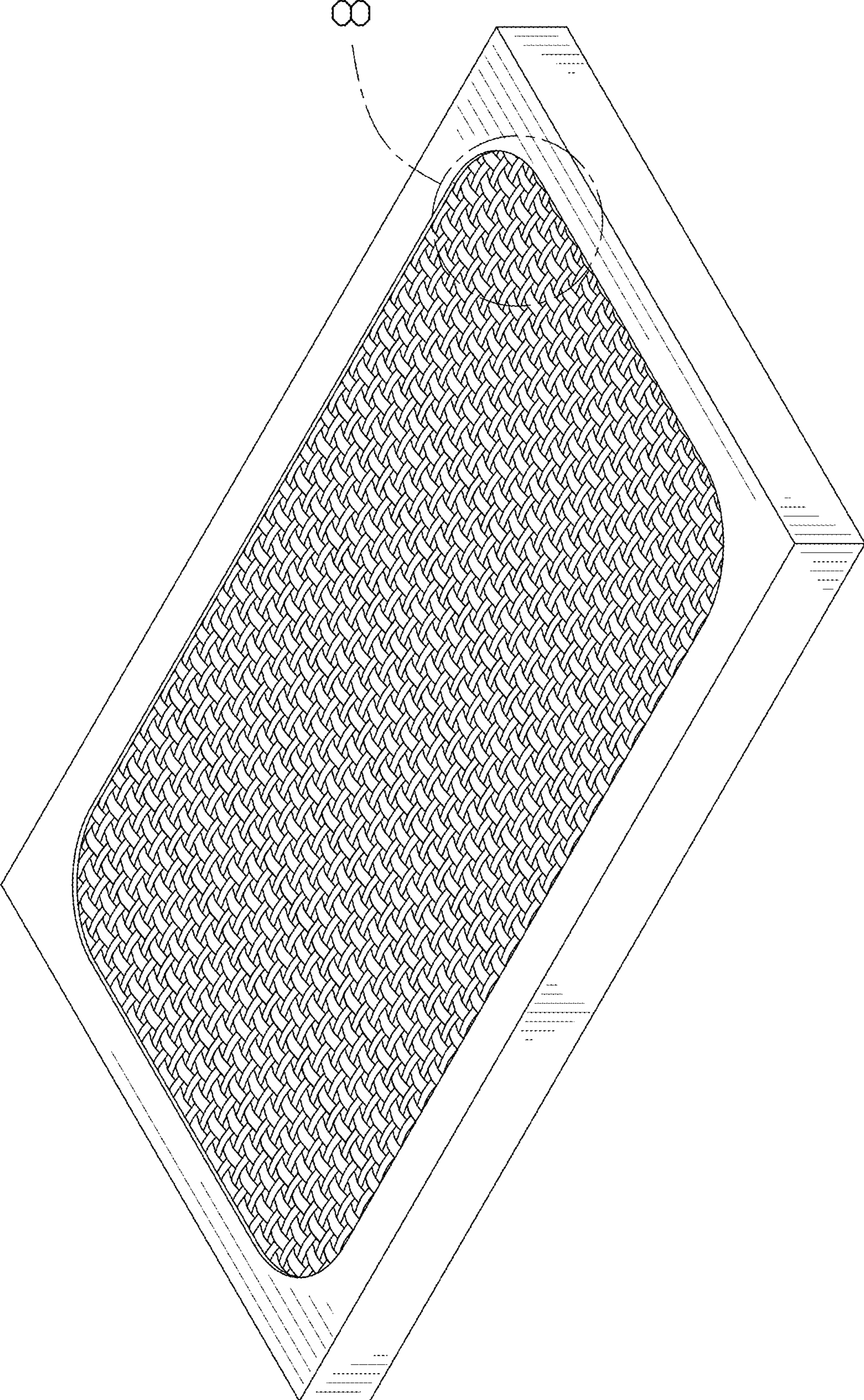

FIG. 1

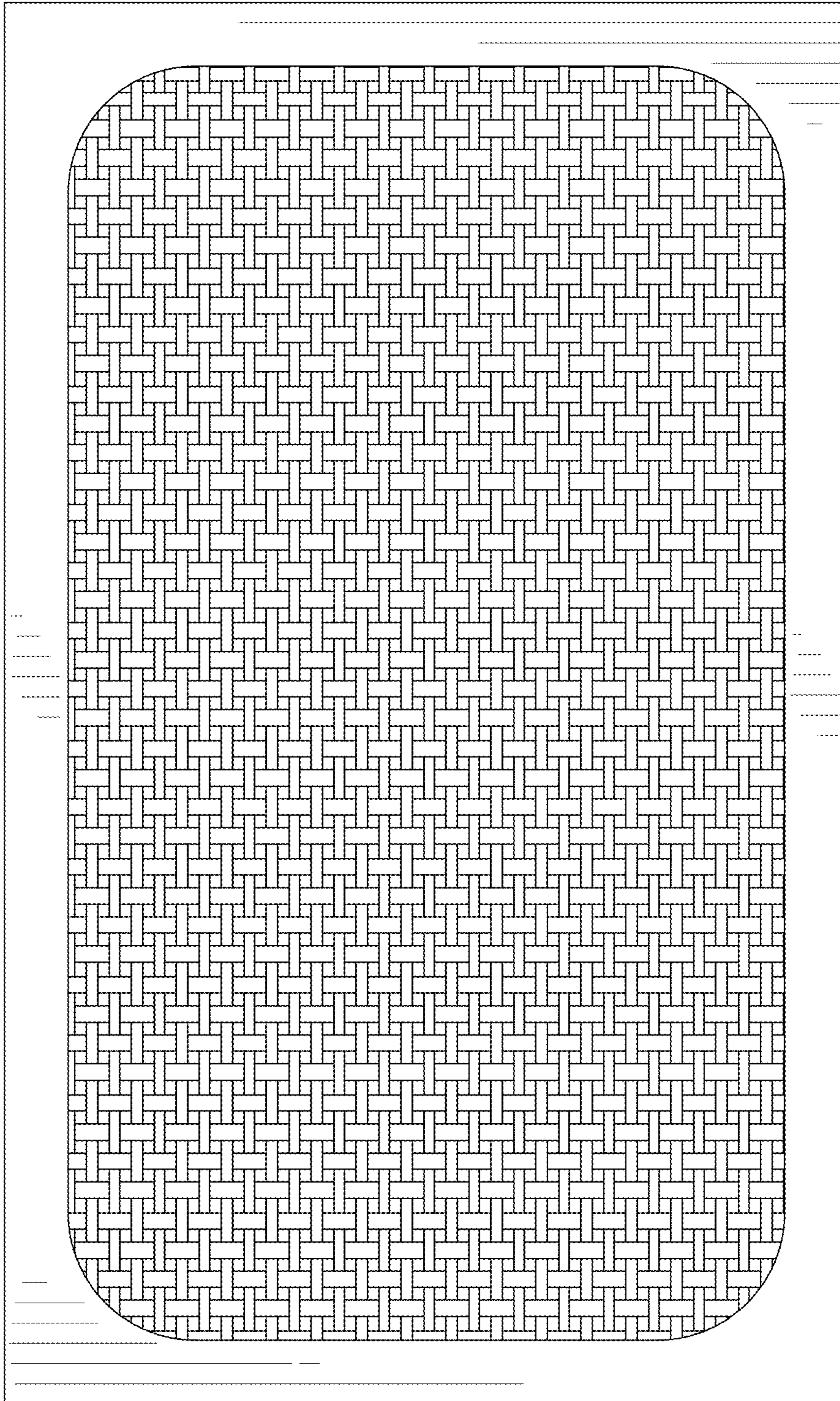

FIG. 2

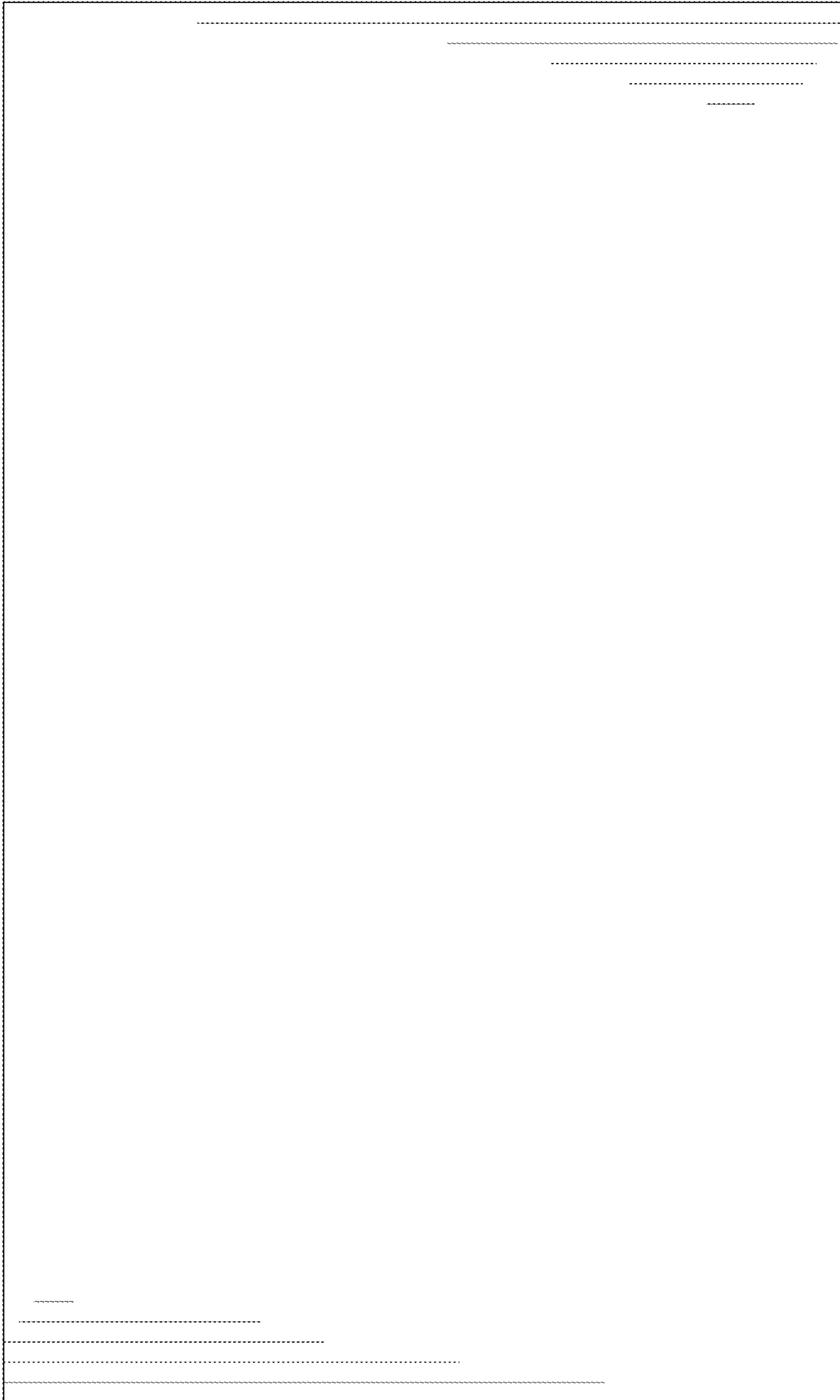

FIG. 3



FIG. 4



FIG. 5

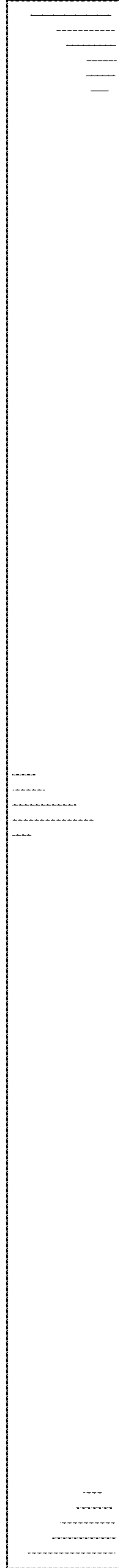

FIG. 6

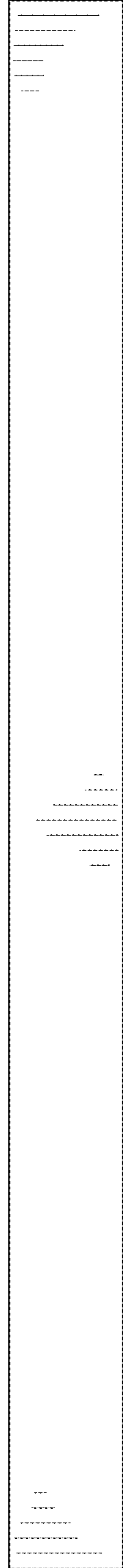

FIG. 7

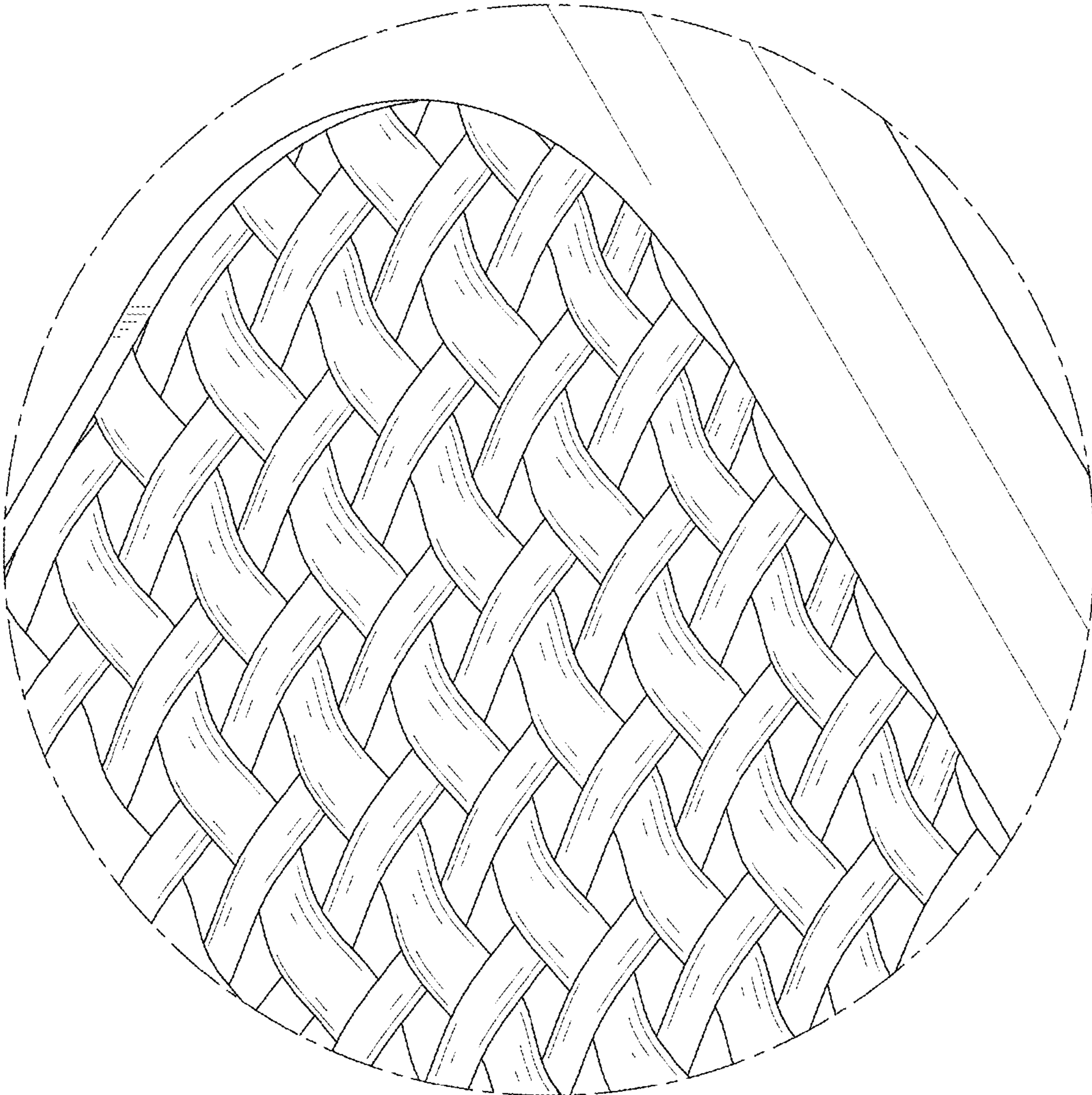

FIG. 8