



US00D953636S

(12) **United States Design Patent**
Jin

(10) **Patent No.:** **US D953,636 S**

(45) **Date of Patent:** **** May 31, 2022**

(54) **HAIR DRYER**

(71) Applicant: **Shenzhen DJ Innovation Industry Co., Ltd, Shenzhen (CN)**

(72) Inventor: **Bo Jin, Shenzhen (CN)**

(**) Term: **15 Years**

(21) Appl. No.: **29/766,985**

(22) Filed: **Jan. 20, 2021**

(51) **LOC (13) Cl.** **28-03**

(52) **U.S. Cl.**
USPC **D28/13**

(58) **Field of Classification Search**
USPC D28/12-19; D8/29.1
CPC A45D 20/00; A45D 20/04; A45D 20/08;
A45D 20/10; A45D 20/12; A45D
2020/128

See application file for complete search history.

(56) **References Cited**

U.S. PATENT DOCUMENTS

D248,576 S * 7/1978 Janssens D28/12
D318,347 S * 7/1991 Hirose D28/12
D349,570 S * 8/1994 Radtke, Jr. D23/382
D671,630 S * 11/2012 Hideharu D23/382

D676,123 S * 2/2013 Hideharu D23/370
D701,298 S * 3/2014 Daisaku D23/370
D903,088 S * 11/2020 Chen D23/382
D917,035 S * 4/2021 Zhou D23/370

* cited by examiner

Primary Examiner — Zenia I Bennett

(57) **CLAIM**

The ornamental design for a hair dryer, as shown and described.

DESCRIPTION

FIG. 1 is a first perspective view of a hair dryer showing my new design;
FIG. 2 is a second perspective view thereof;
FIG. 3 is a front view thereof;
FIG. 4 is a back view thereof;
FIG. 5 is a left side view thereof;
FIG. 6 is a right side view thereof;
FIG. 7 is a top view thereof;
FIG. 8 is a bottom view thereof; and,
FIG. 9 is a perspective view of another state of the hair dryer thereof.

The broken lines shown in the drawings depict portions of the hair dryer in which the design is embodied that form no part of the claimed design.

1 Claim, 9 Drawing Sheets

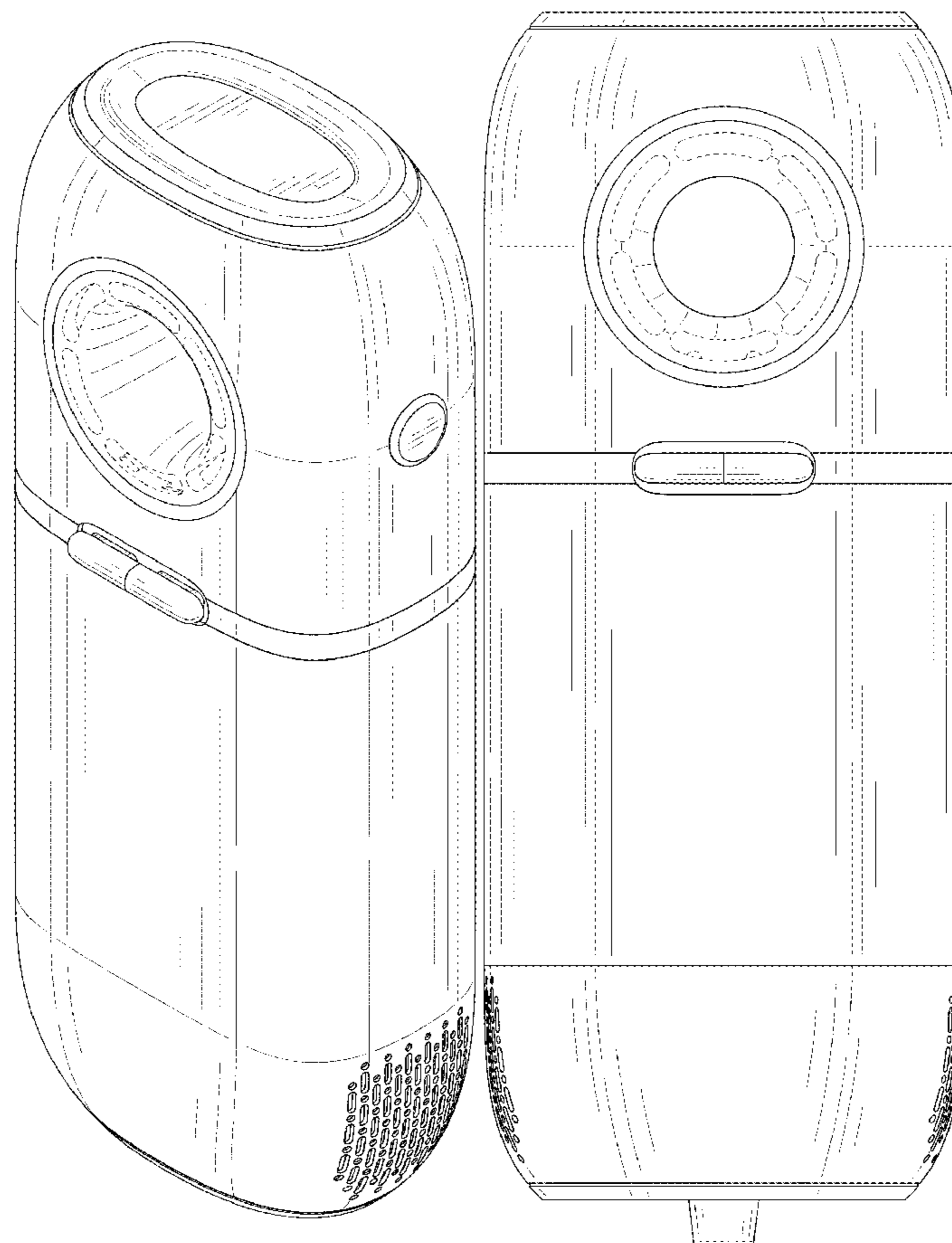

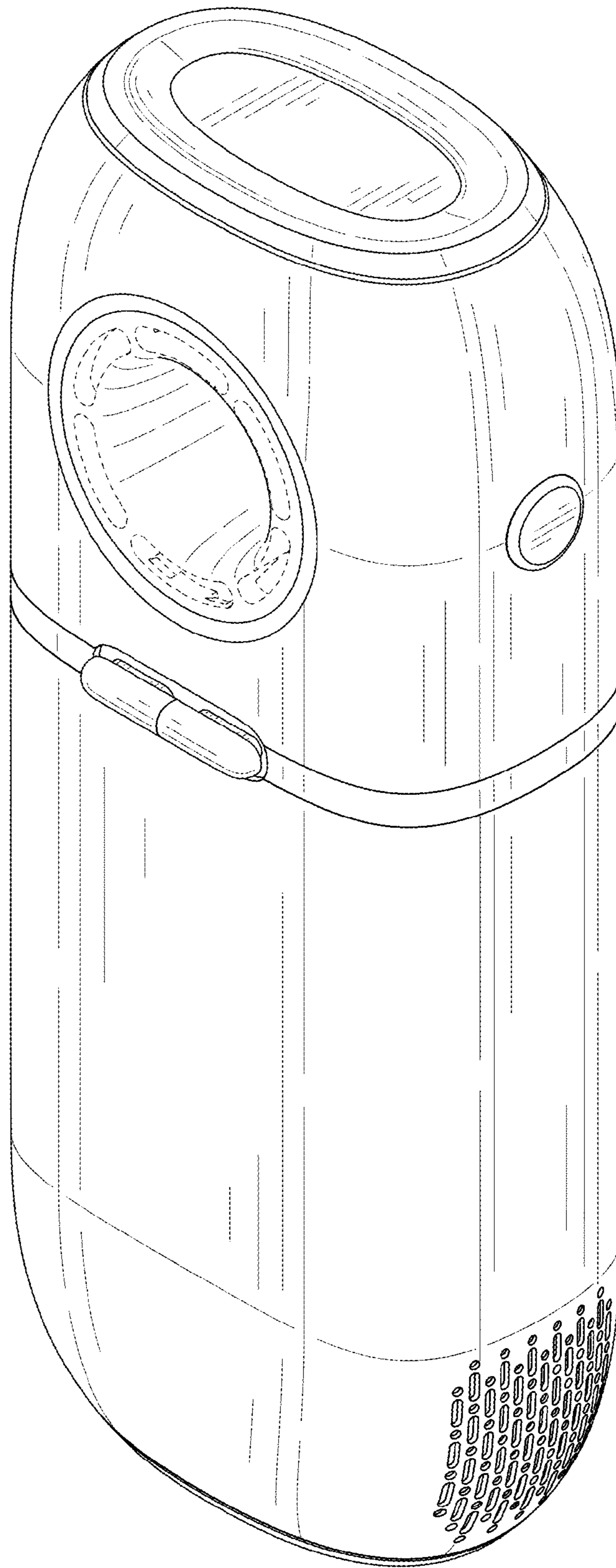

FIG. 1

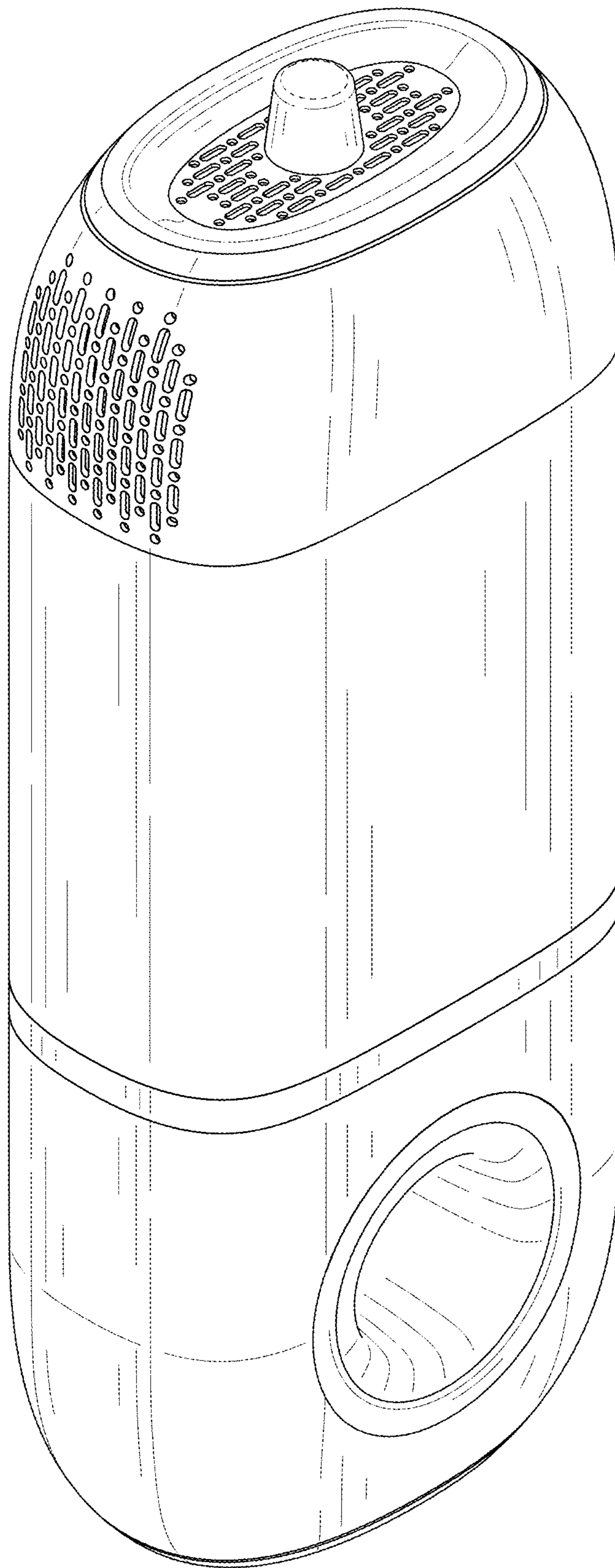

FIG. 2

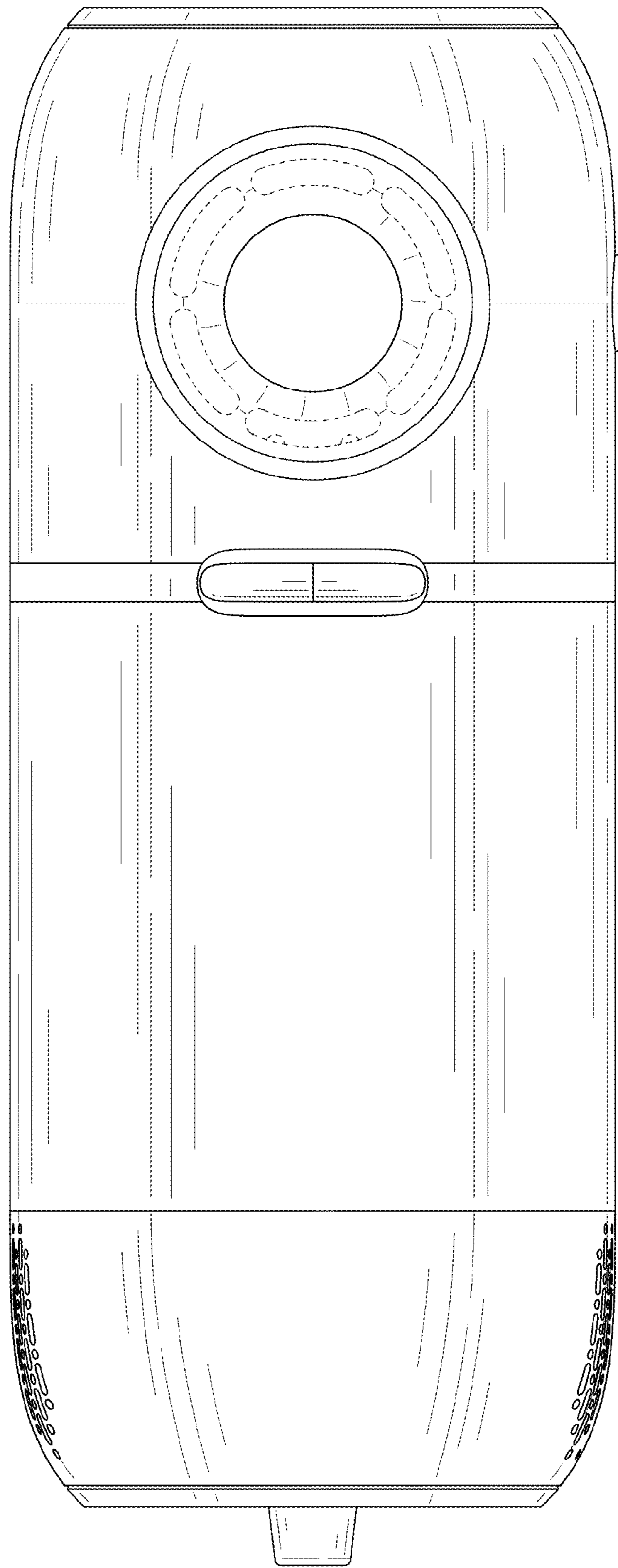

FIG. 3

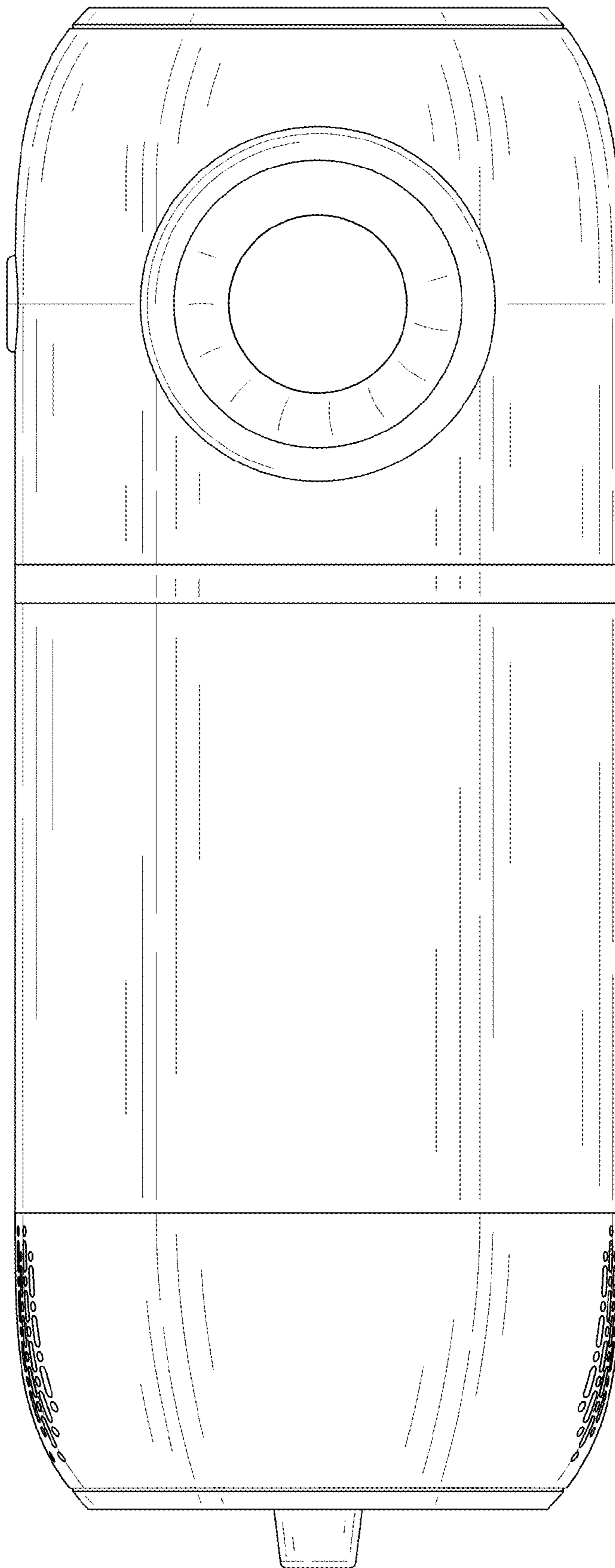

FIG. 4

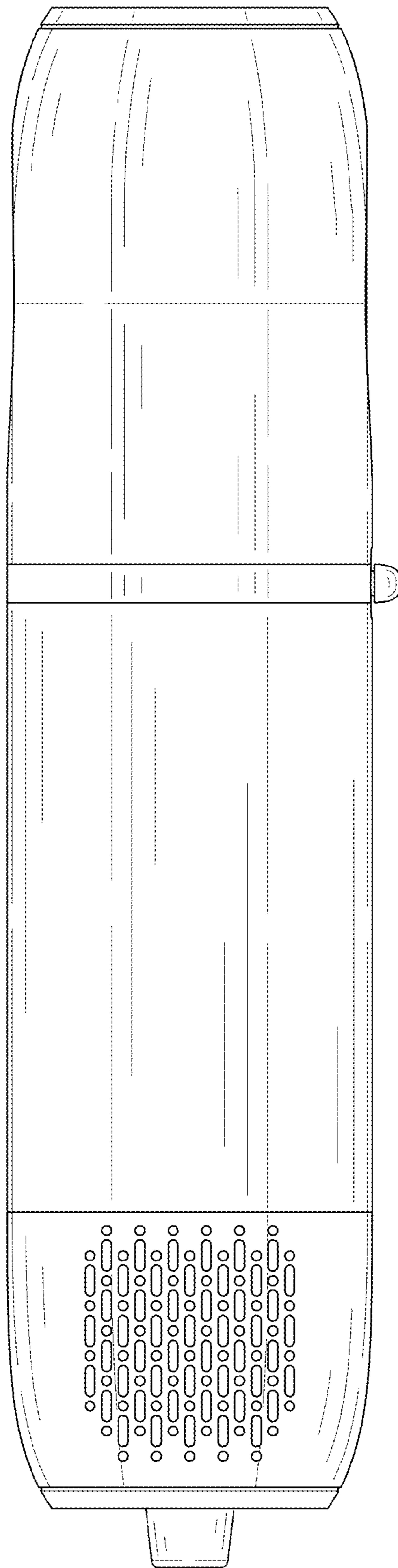

FIG. 5

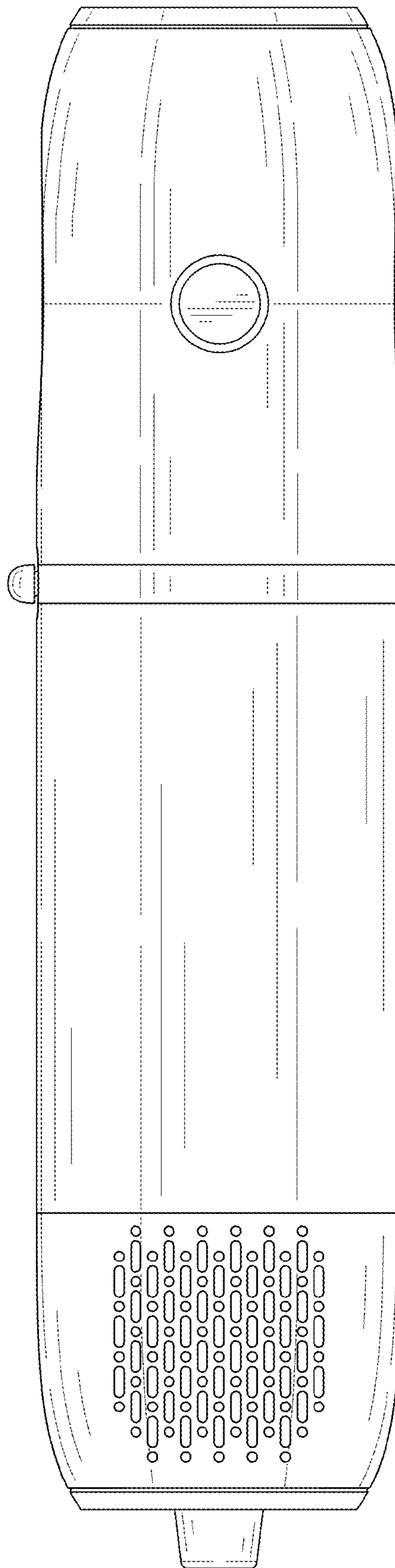

FIG. 6

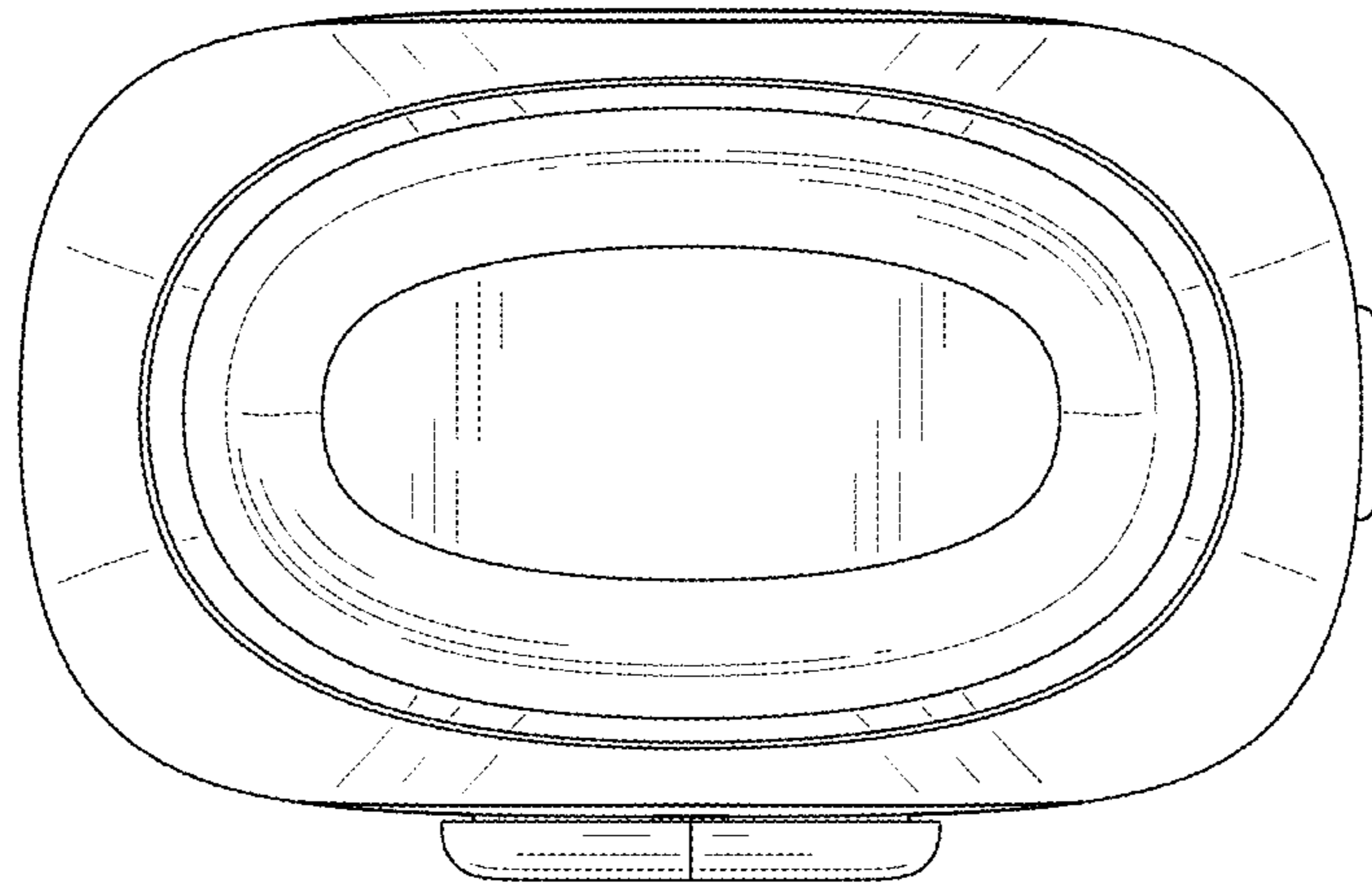

FIG. 7

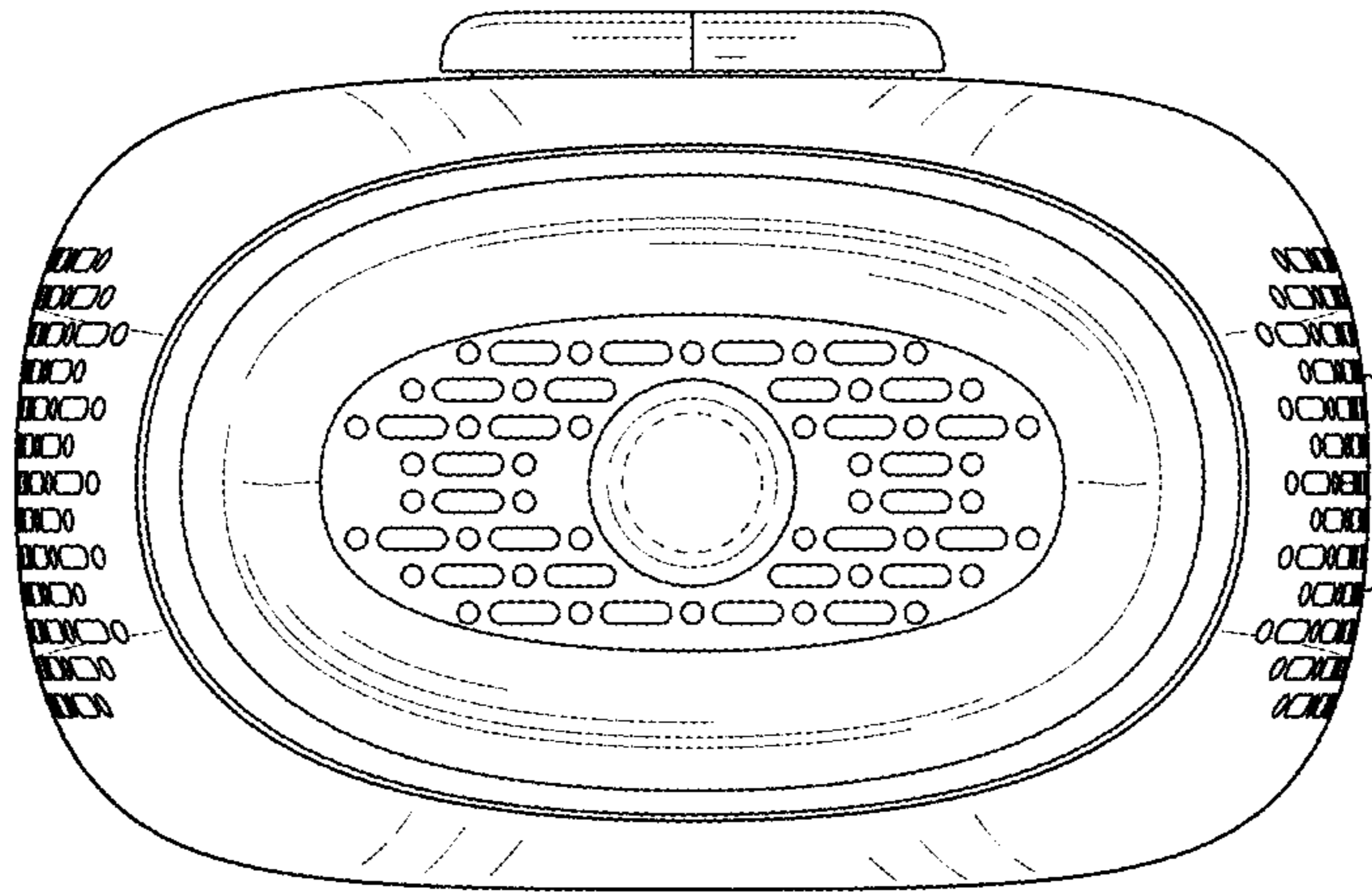

FIG. 8

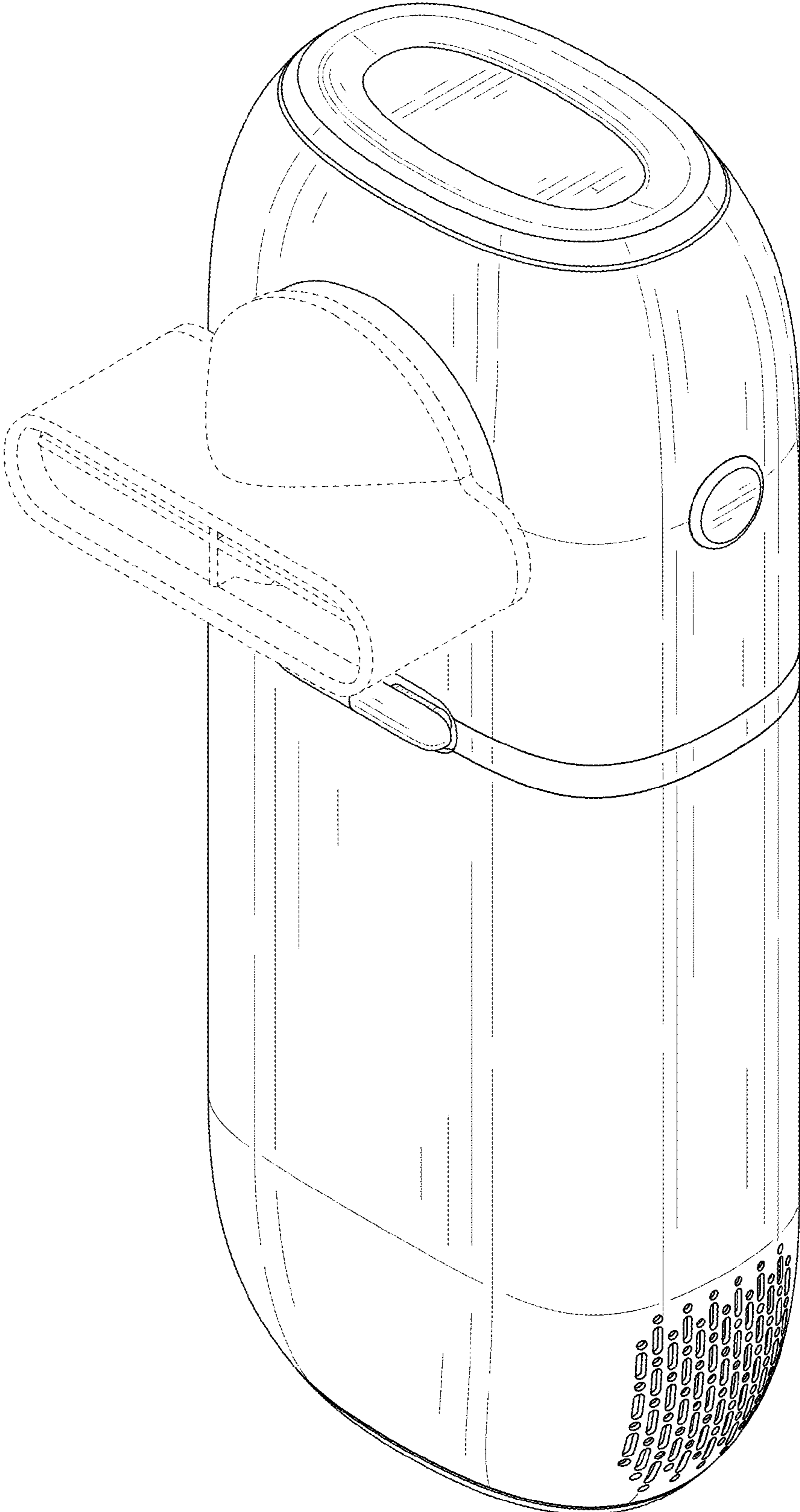

FIG. 9