



US00D953625S

(12) **United States Design Patent**
Liao et al.

(10) **Patent No.:** **US D953,625 S**

(45) **Date of Patent:** **** May 31, 2022**

(54) **DISPOSABLE ELECTRONIC CIGARETTE**

(71) Applicant: **Guangdong Qisitech CO., LTD,**
Guangdong (CN)

(72) Inventors: **Weixue Liao,** Guangdong (CN);
Xiaolong Du, Guangdong (CN); **Hu**
Ding, Guangdong (CN)

(73) Assignee: **Guangdong Qisitech CO., LTD,**
Dongguan (CN)

(**) Term: **15 Years**

(21) Appl. No.: **29/768,664**

(22) Filed: **Jan. 31, 2021**

(30) **Foreign Application Priority Data**

Dec. 30, 2020 (CN) 202030821727.2

(51) **LOC (13) Cl.** **27-02**

(52) **U.S. Cl.**
USPC **D27/162**

(58) **Field of Classification Search**
USPC D27/162, 100, 101, 163–170, 172,
D27/174–176, 183, 185–194; D13/103,
D13/107; D24/110, 100.5; D23/360,
D23/363, 366
CPC A24F 47/00; A24F 47/02; A24F 47/04;
A24F 47/08; A24F 1/30; A24F 1/02;
A24F 1/00
See application file for complete search history.

(56) **References Cited**

U.S. PATENT DOCUMENTS

D799,110 S * 10/2017 Qiu D27/101
D799,113 S * 10/2017 Qiu D27/101
D815,341 S * 4/2018 Qiu D27/101
D818,636 S * 5/2018 Qiu D27/101
D829,980 S * 10/2018 Qiu D27/162
D832,500 S * 10/2018 Qiu D27/162

D853,632 S * 7/2019 Qiu D27/101
D855,251 S * 7/2019 Qiu D27/162
D859,735 S * 9/2019 Qiu D27/162
D870,372 S * 12/2019 Zhu D27/167
D874,059 S * 1/2020 Bailey D27/162
D876,004 S * 2/2020 Wang D27/101
D902,475 S * 11/2020 Liu D27/101
D908,952 S * 1/2021 Guo D27/101
D910,906 S * 2/2021 Zhou D27/162
D919,881 S * 5/2021 Carlberg D27/162
D924,476 S * 7/2021 Li D27/162
D929,651 S * 8/2021 Powell D27/162
D937,480 S * 11/2021 Liu D27/162
D938,646 S * 12/2021 Zhang D27/162

(Continued)

OTHER PUBLICATIONS

Disposable Vape Pen By PachaMama found on line Mar. 10, 2022)
[https://blackoutvapors.com/product/pachamama-disposable-vape/](https://blackoutvapors.com/product/pachamama-disposable-vape/#reviews)
#reviews (Oct. 4, 2021).*

Primary Examiner — Rebecca Tsehaye

(57) **CLAIM**

The ornamental design for a disposable electronic cigarette,
as shown and described.

DESCRIPTION

FIG. 1 is a top, front and right side perspective view of a
disposable electronic cigarette showing our new design;
FIG. 2 is a bottom, rear and right side perspective view
thereof;
FIG. 3 is a front elevational view thereof;
FIG. 4 is a rear elevational view thereof;
FIG. 5 is a left side view thereof;
FIG. 6 is a right side view thereof;
FIG. 7 is a top plan view thereof; and,
FIG. 8 is a bottom plan view thereof.
The oblique shade lines in the drawings represent a trans-
parent surface.

1 Claim, 8 Drawing Sheets

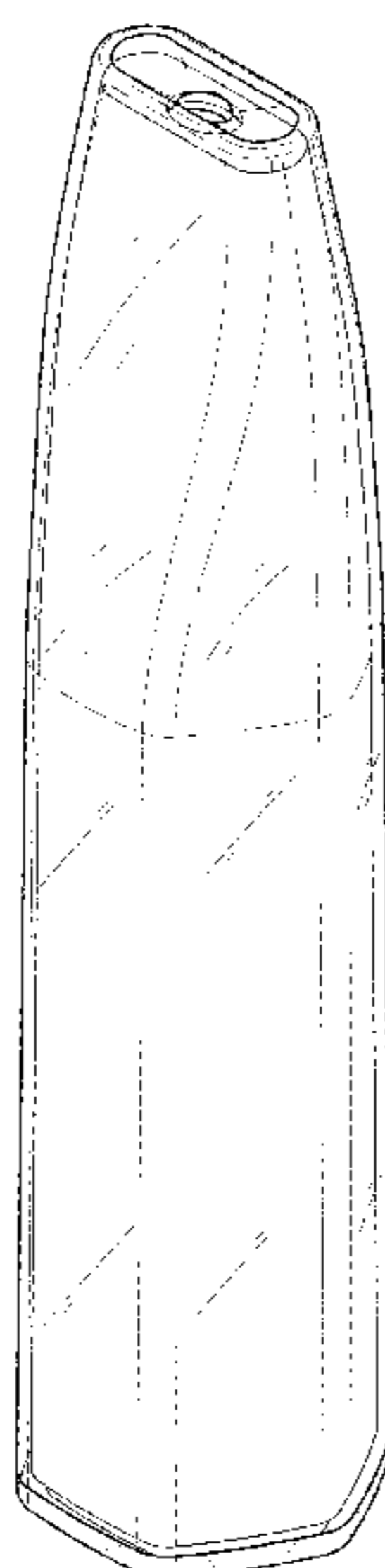

(56)

References Cited

U.S. PATENT DOCUMENTS

D943,173 S * 2/2022 Liu D27/162
D945,698 S * 3/2022 Morgan D27/162

* cited by examiner

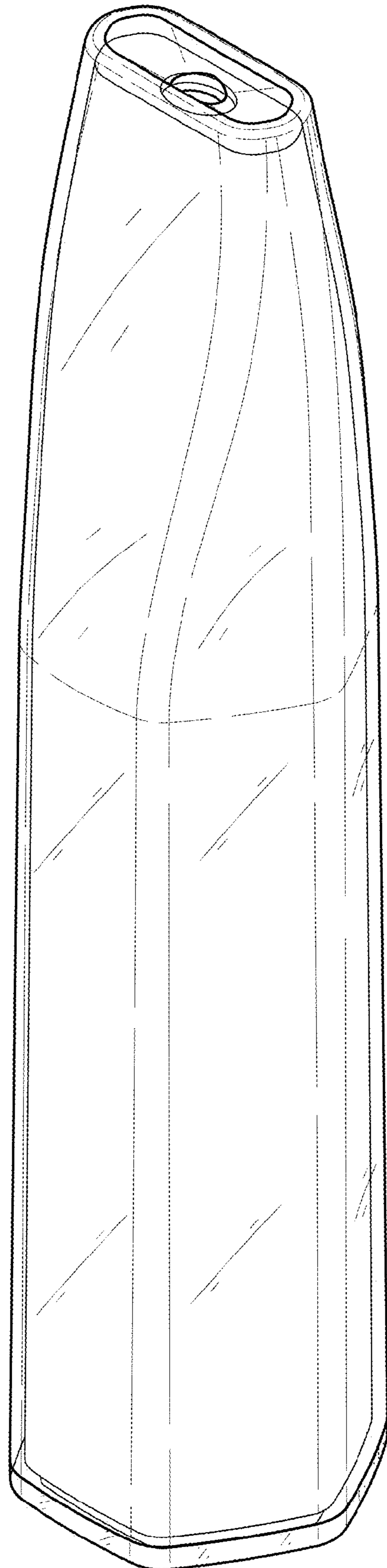

FIG. 1

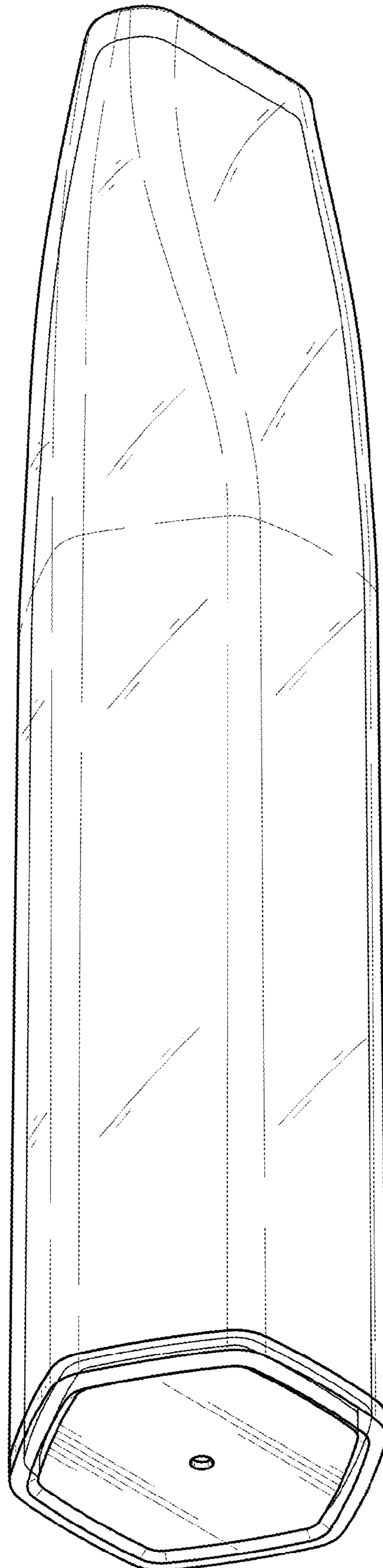

FIG. 2

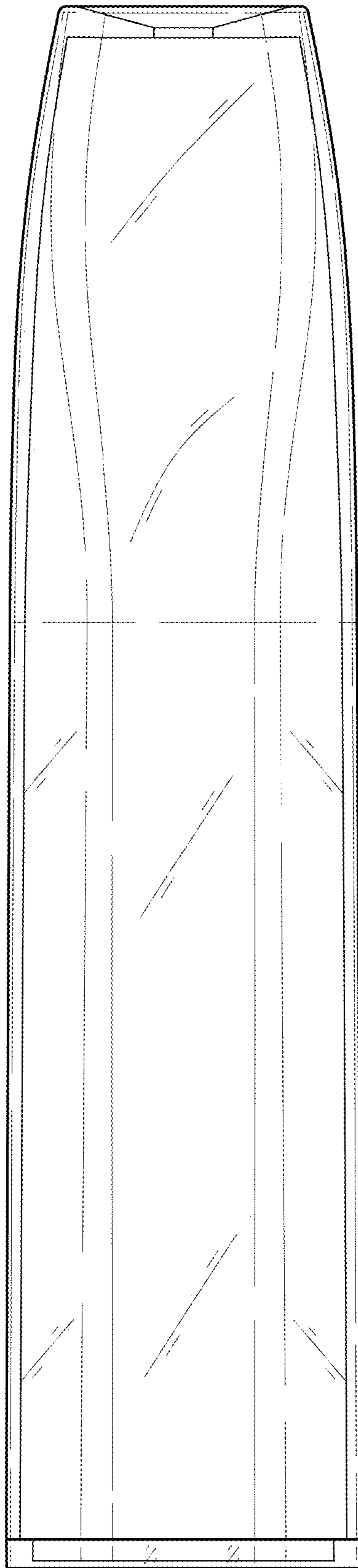

FIG. 3

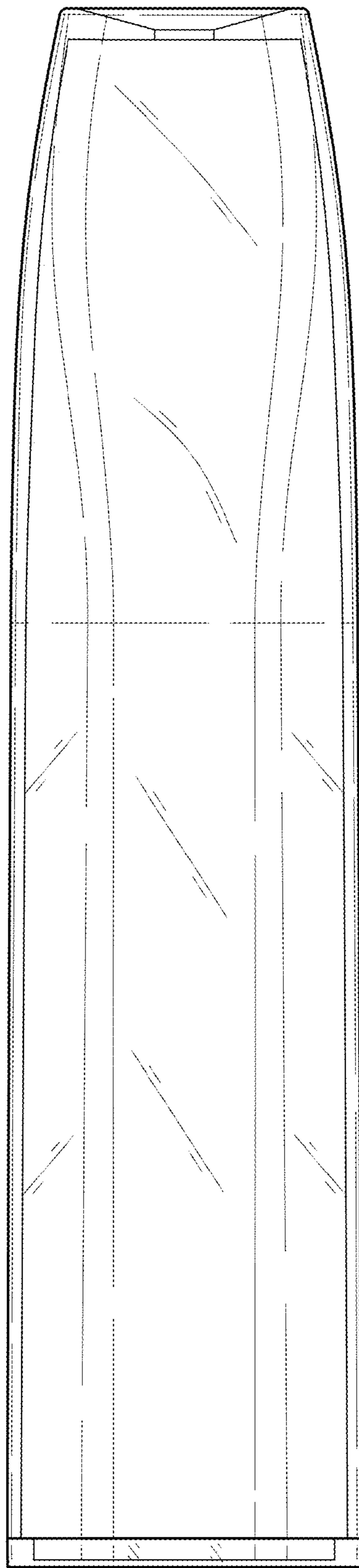

FIG. 4

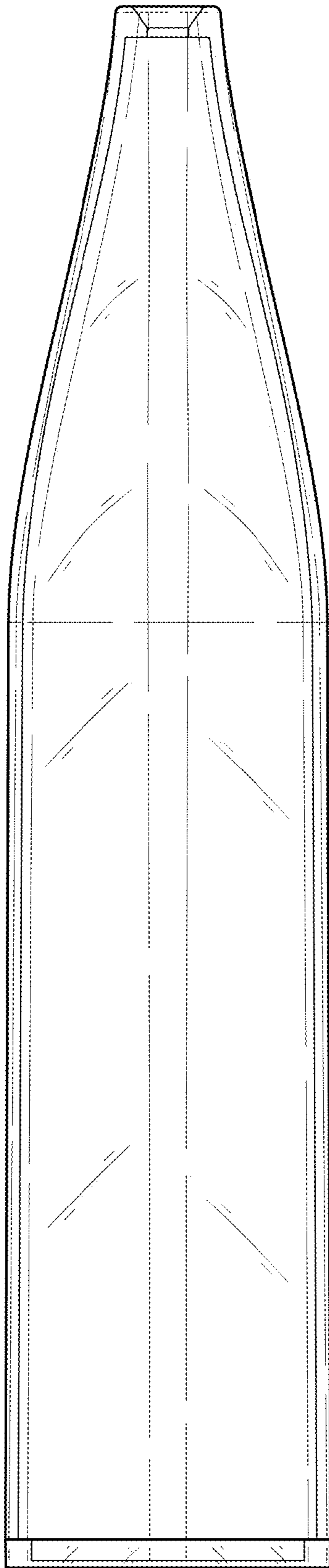

FIG. 5

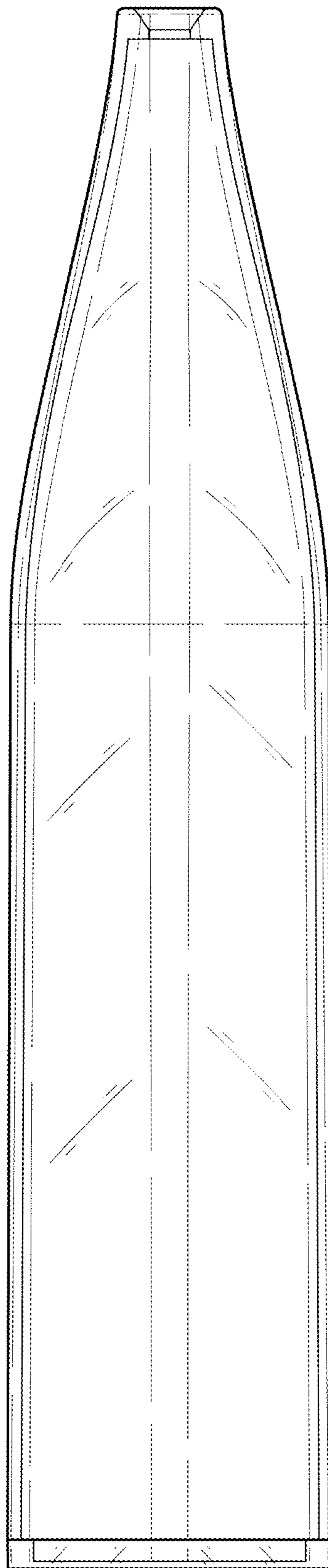

FIG. 6

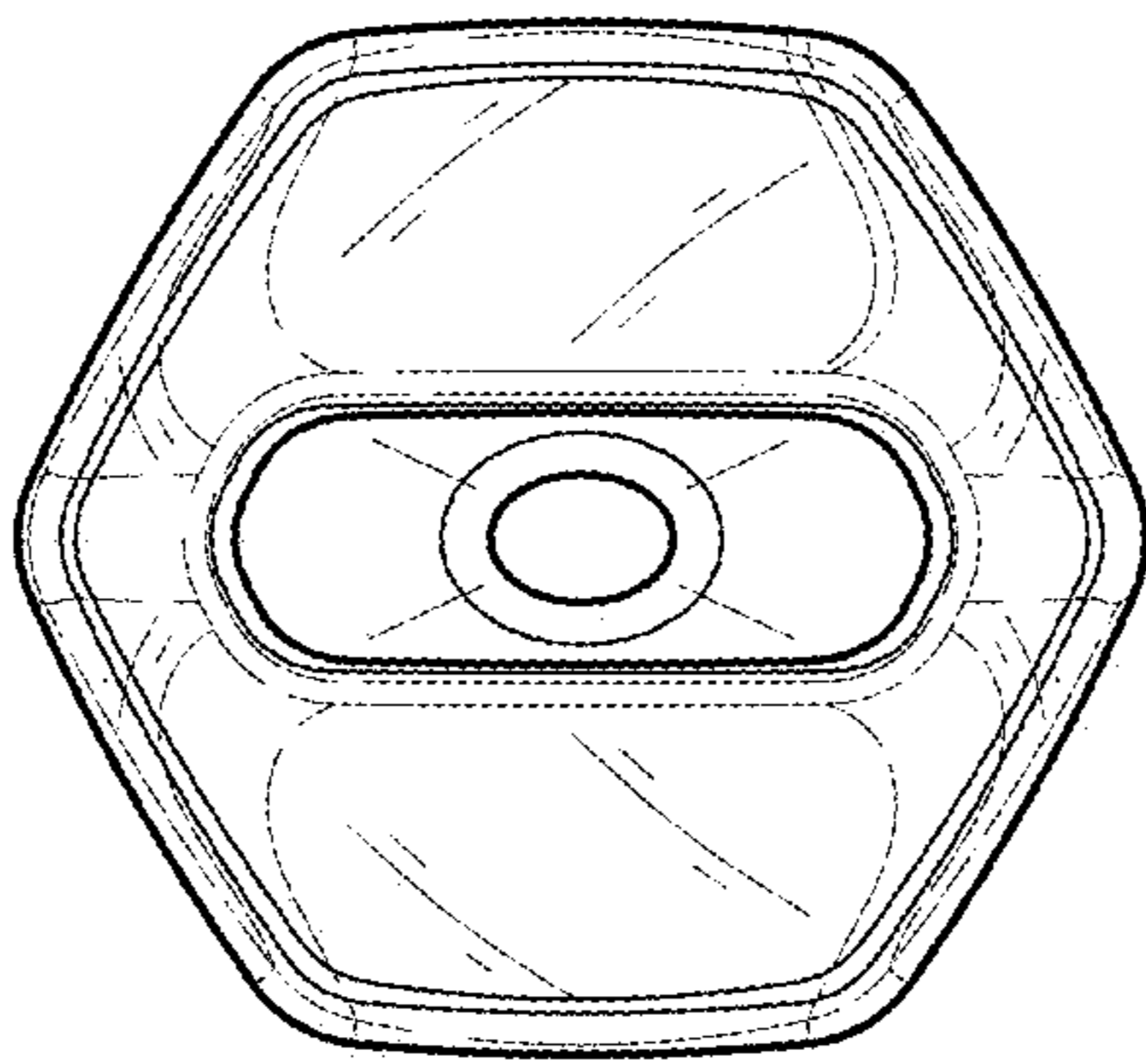

FIG. 7

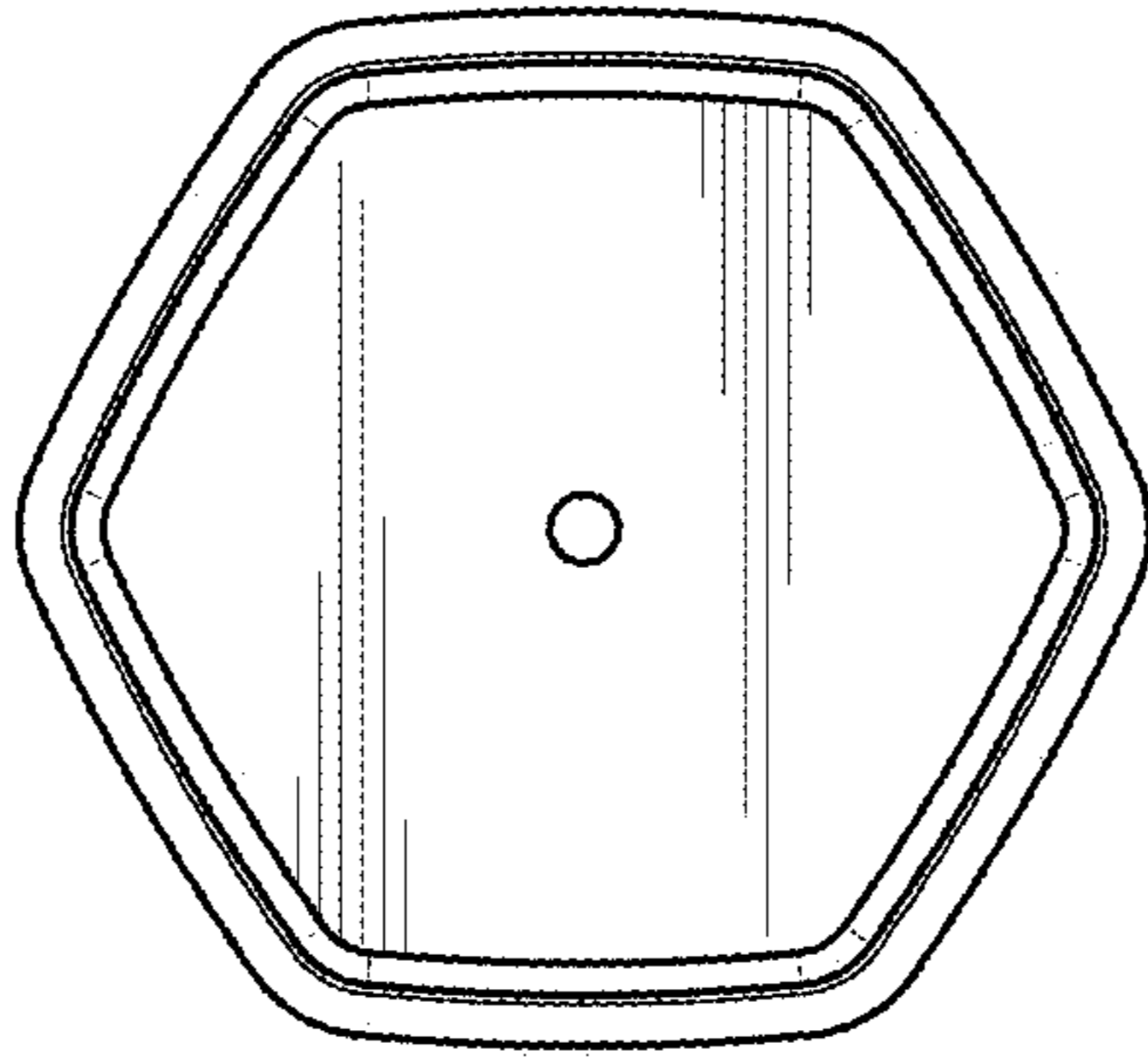

FIG. 8