



US00D953513S

(12) **United States Design Patent** (10) **Patent No.:** **US D953,513 S**  
**Trazzi** (45) **Date of Patent:** **\*\* May 31, 2022**

(54) **AIR FRESHENER**  
(71) Applicant: **JOY FRAGRANCES S.R.L.**, Busto Arsizio (IT)

D802,728 S \* 11/2017 Trazzi ..... D23/367  
D897,519 S \* 9/2020 Giovannoni ..... D23/367  
2009/0255482 A1\* 10/2009 Santarsiero ..... A01K 15/025  
119/707

(72) Inventor: **Luca Trazzi**, Busto Arsizio (IT)  
(73) Assignee: **JOY FRAGRANCES S.R.L.**, Busto Arsizio (IT)

\* cited by examiner

*Primary Examiner* — Michael A. Pratt  
(74) *Attorney, Agent, or Firm* — Leason Ellis LLP

(\*\*) Term: **15 Years**

(57) **CLAIM**

The ornamental design for the air fresheners, as shown and described.

(21) Appl. No.: **35/510,571**

**DESCRIPTION**

(22) Filed: **Apr. 14, 2020**

FIG. 1.1 is a perspective view of an air freshener showing a first embodiment;

(80) **Hague Agreement Data**

Int. Filing Date: **Apr. 14, 2020**  
Int. Reg. No.: **DM/207614**  
Int. Reg. Date: **Apr. 14, 2020**  
Int. Reg. Pub. Date: **Oct. 16, 2020**

FIG. 1.2 is a front view thereof;

FIG. 1.3 is a right side view thereof;

FIG. 1.4 is a rear view thereof;

FIG. 1.5 is a left side view thereof;

FIG. 1.6 is a top plan view thereof;

FIG. 1.7 is a bottom plan view thereof;

FIG. 2.1 is a perspective view of an air freshener showing a second embodiment;

(30) **Foreign Application Priority Data**

Oct. 14, 2019 (EM) ..... 007020763

FIG. 2.2 is a front view thereof;

FIG. 2.3 is a right side view thereof;

FIG. 2.4 is a rear view thereof;

FIG. 2.5 is a left side view thereof;

FIG. 2.6 is a top plan view thereof;

FIG. 2.7 is a bottom plan view thereof;

FIG. 3.1 is a perspective view of an air freshener showing a third embodiment;

(51) **LOC (13) Cl.** ..... **23-04**

(52) **U.S. Cl.**  
USPC ..... **D23/367**

(58) **Field of Classification Search**

USPC ..... D23/355–369; D28/5, 6, 261, DIG. 17  
CPC ... A61L 9/02; A61L 9/03; A61L 9/034; A61L 9/04; A61L 9/12; A61L 9/032; A61L 9/122; A61L 9/127; A61L 9/22

FIG. 3.2 is a front view thereof;

FIG. 3.3 is a right side view thereof;

FIG. 3.4 is a rear view thereof;

FIG. 3.5 is a left side view thereof;

FIG. 3.6 is a top plan view thereof; and

FIG. 3.7 is a bottom plan view thereof.

The broken line shown is for the purpose of illustrating portions of the air fresheners and forms no part of the claimed design.

See application file for complete search history.

(56) **References Cited**

U.S. PATENT DOCUMENTS

D676,122 S \* 2/2013 Trazzi ..... D23/367  
D747,790 S \* 1/2016 Trazzi ..... D23/366

**1 Claim, 21 Drawing Sheets**

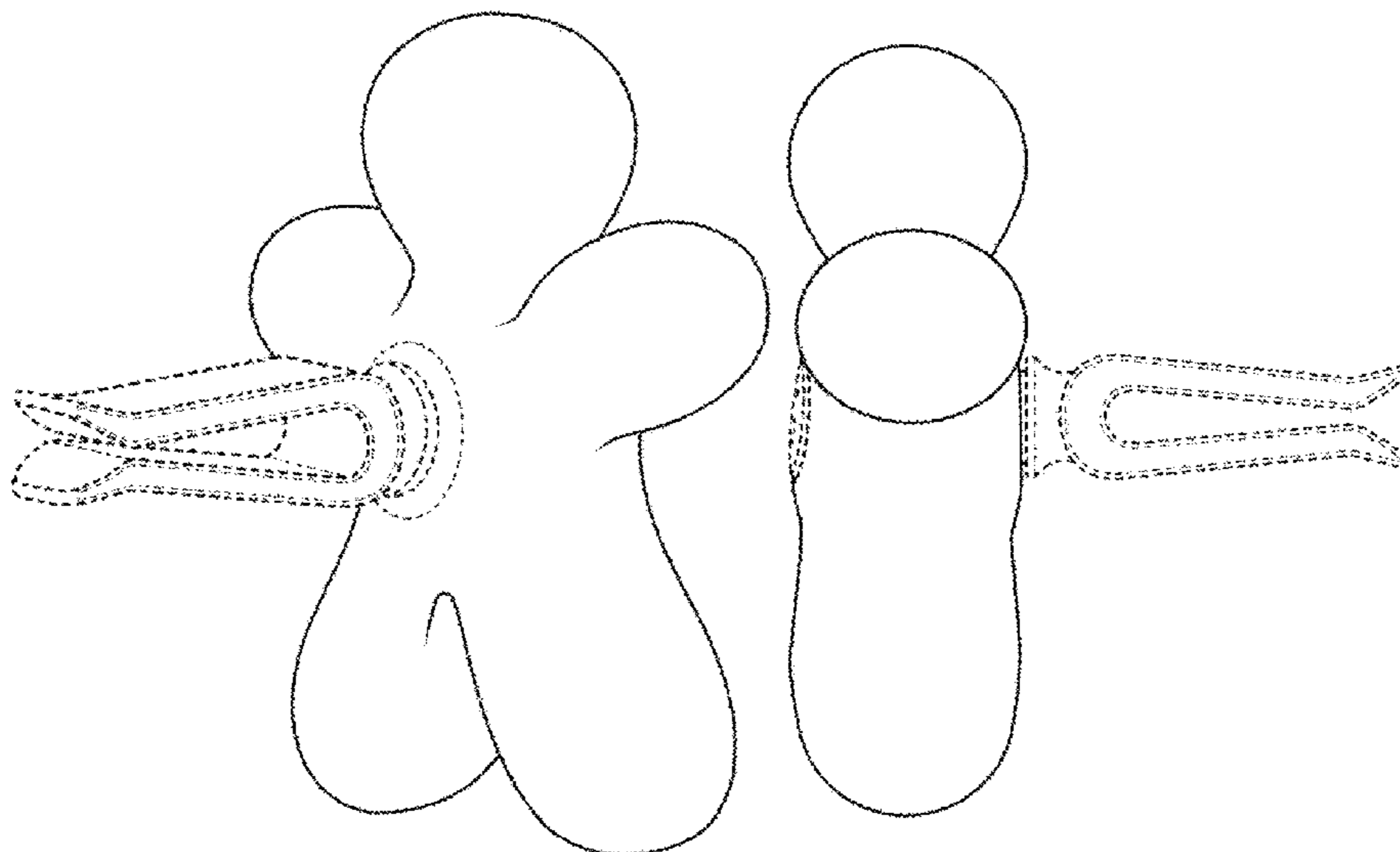

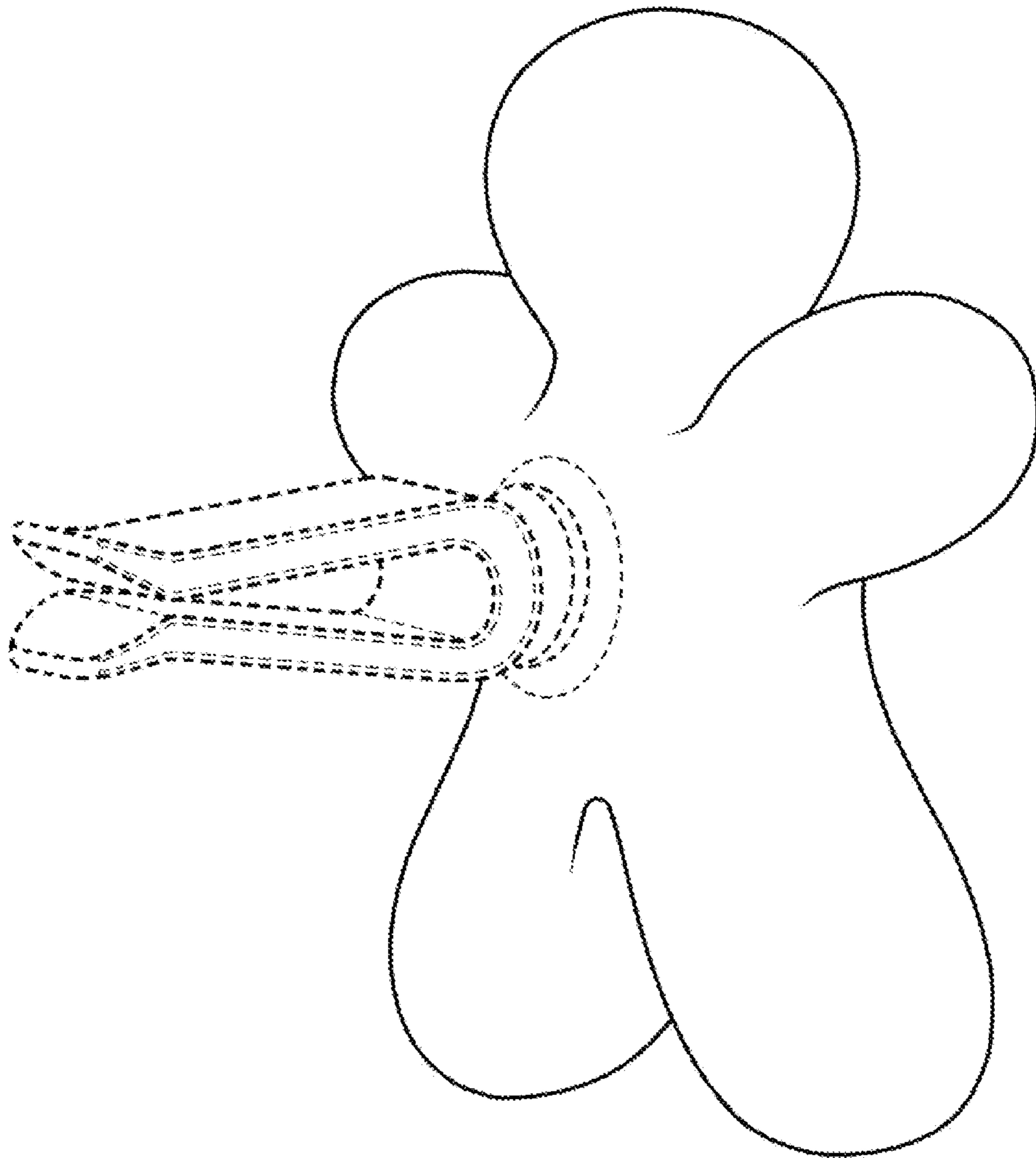

FIG. 1.1

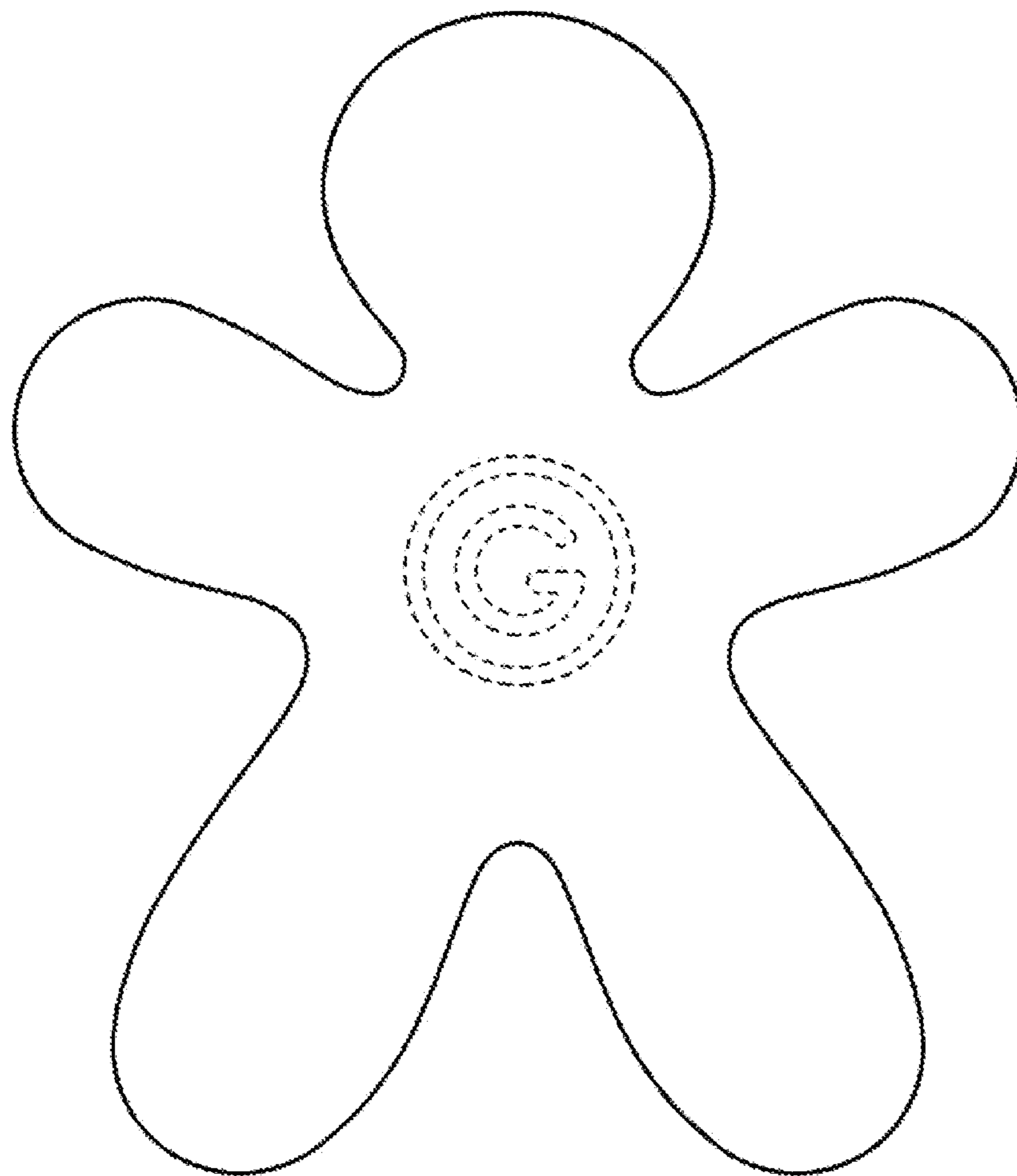

FIG. 1.2

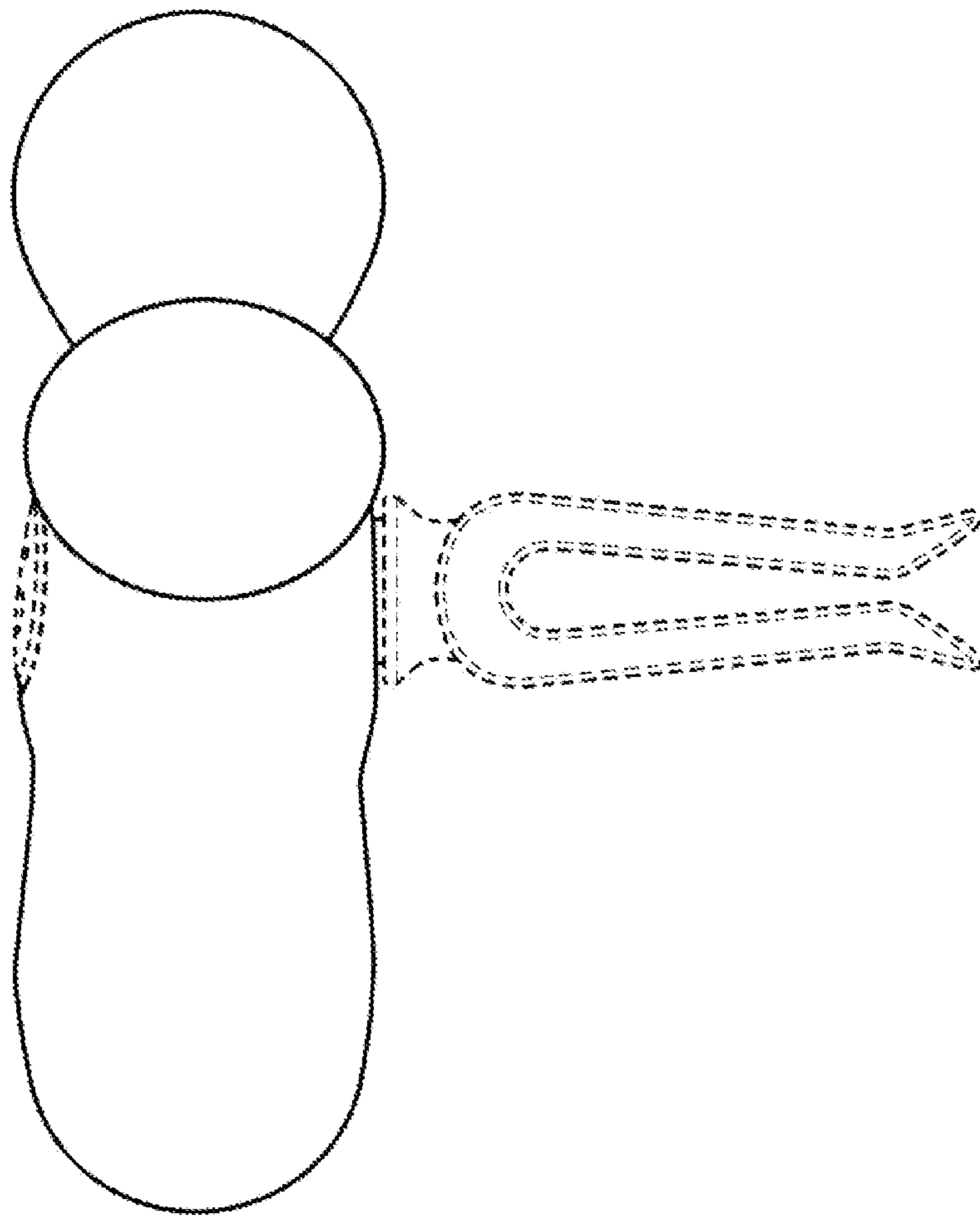

FIG. 1.3

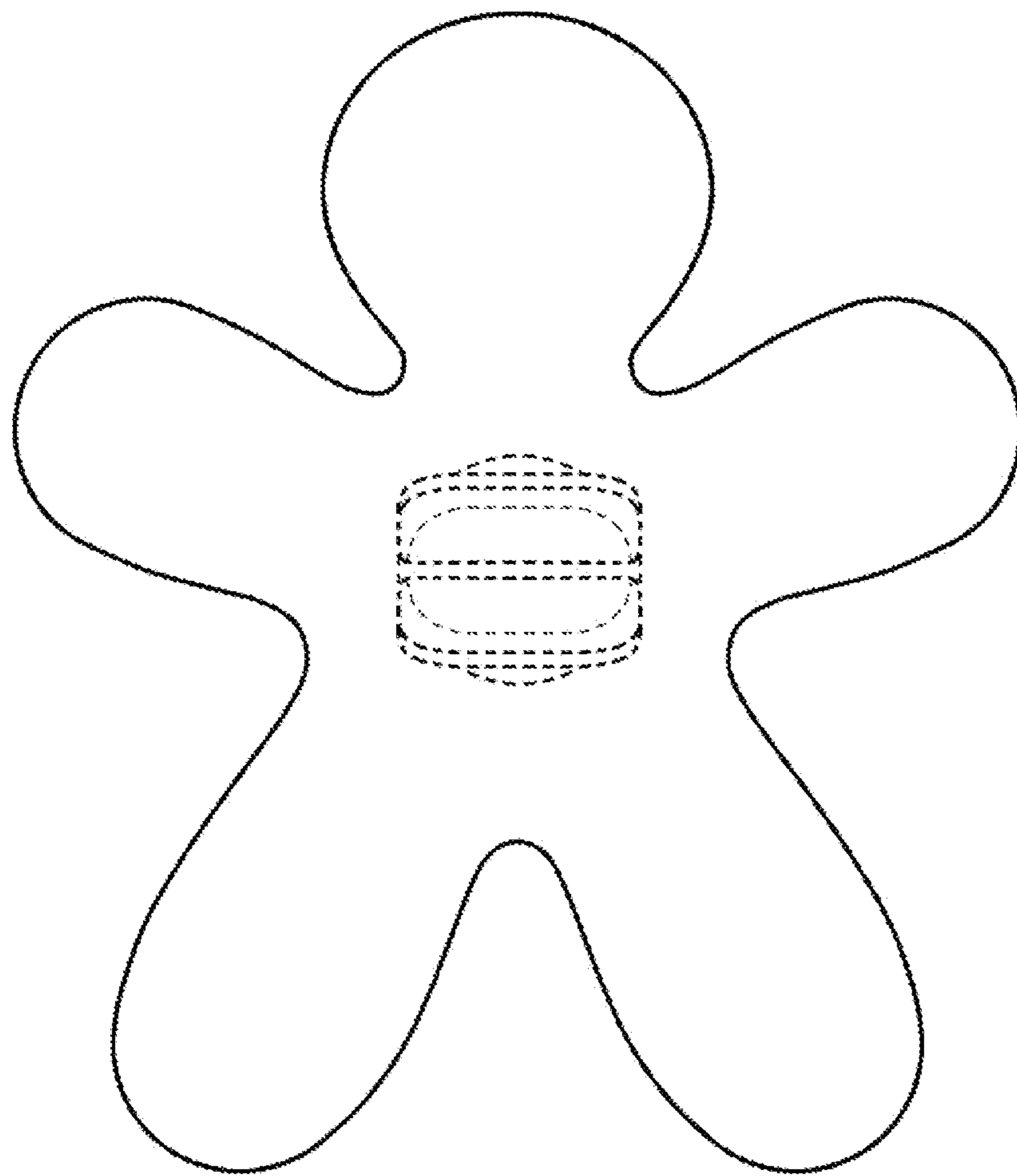

FIG. 1.4

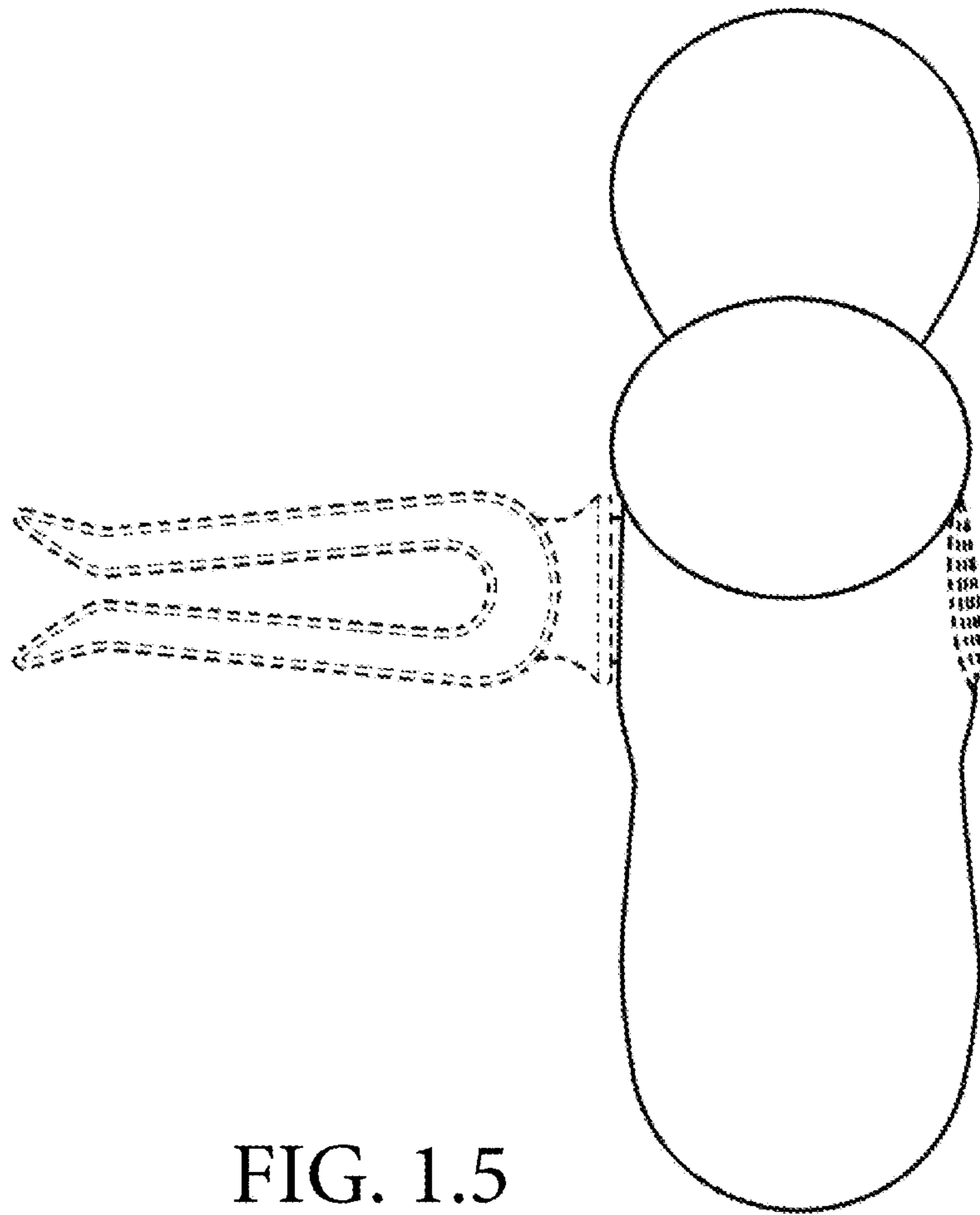

FIG. 1.5

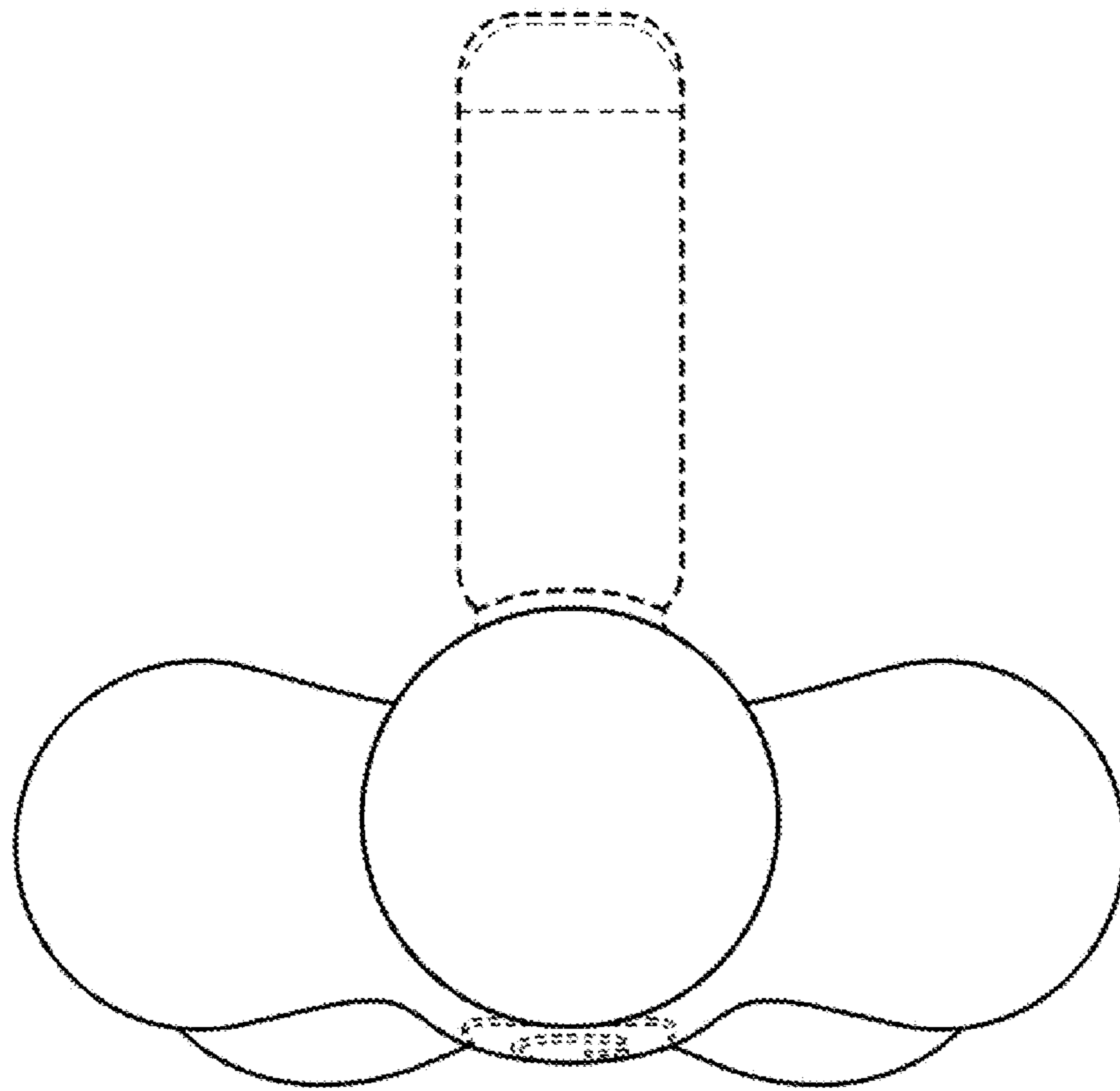

FIG. 1.6

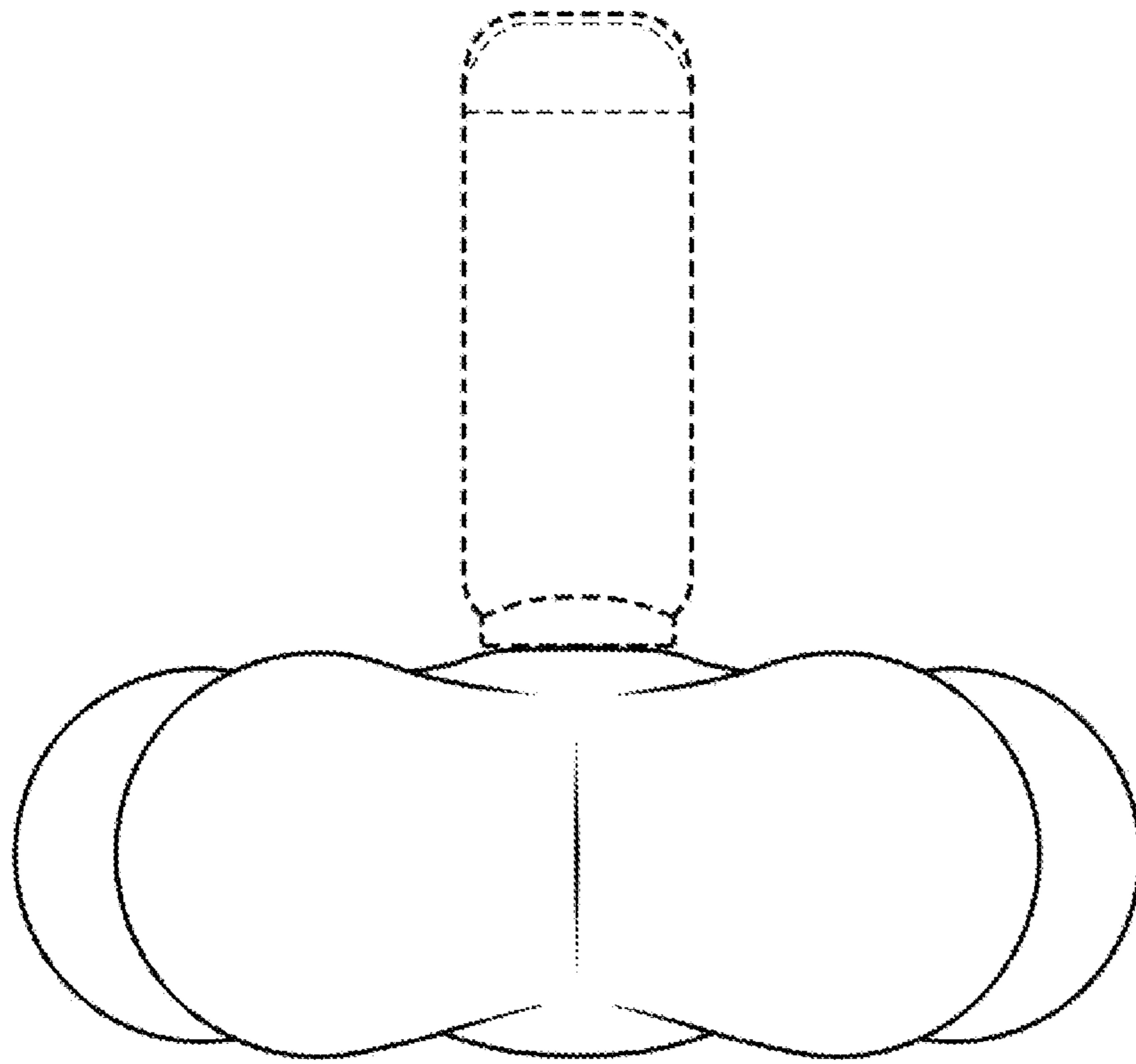

FIG. 1.7



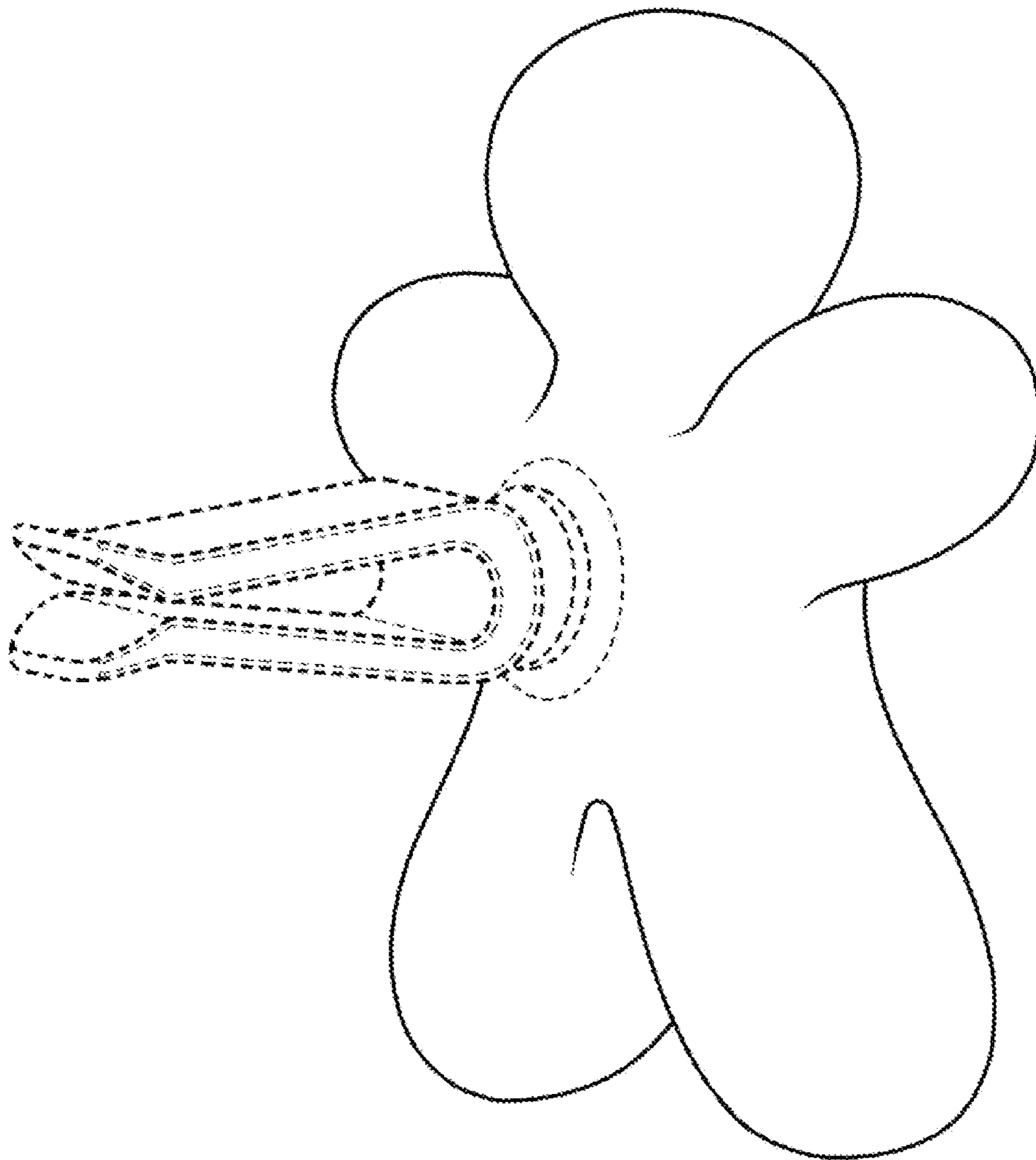

FIG. 2.1

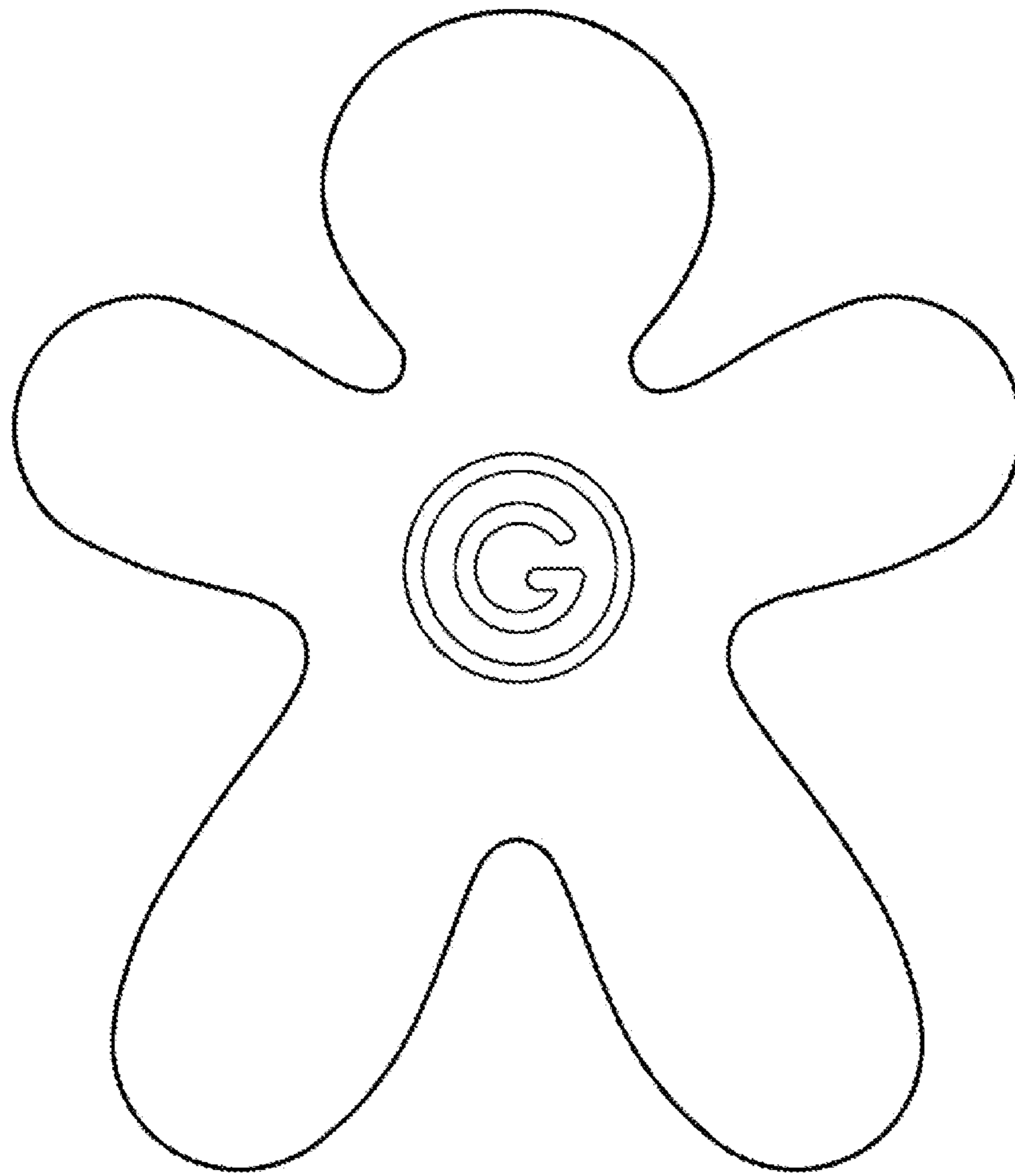

FIG. 2.2

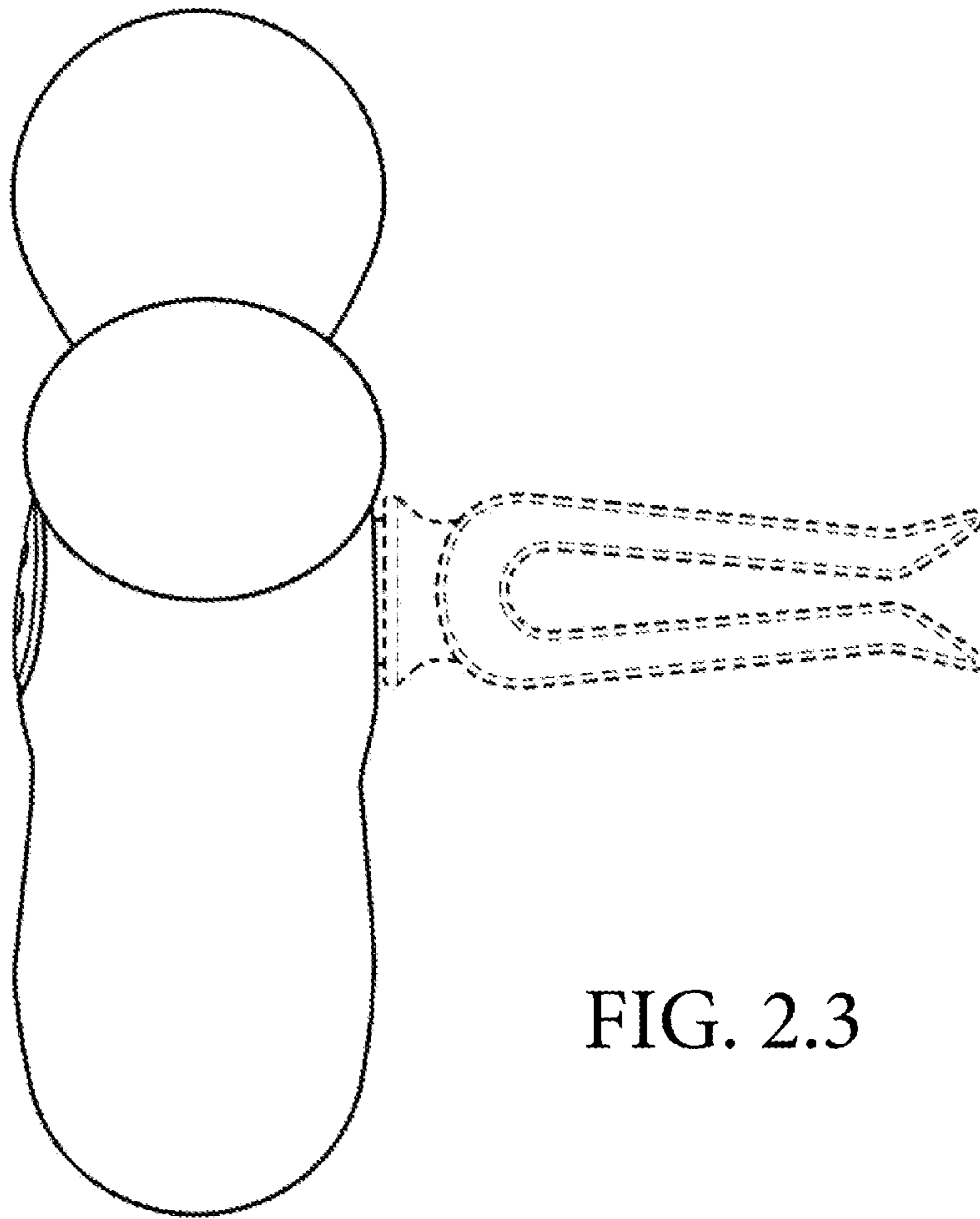

FIG. 2.3

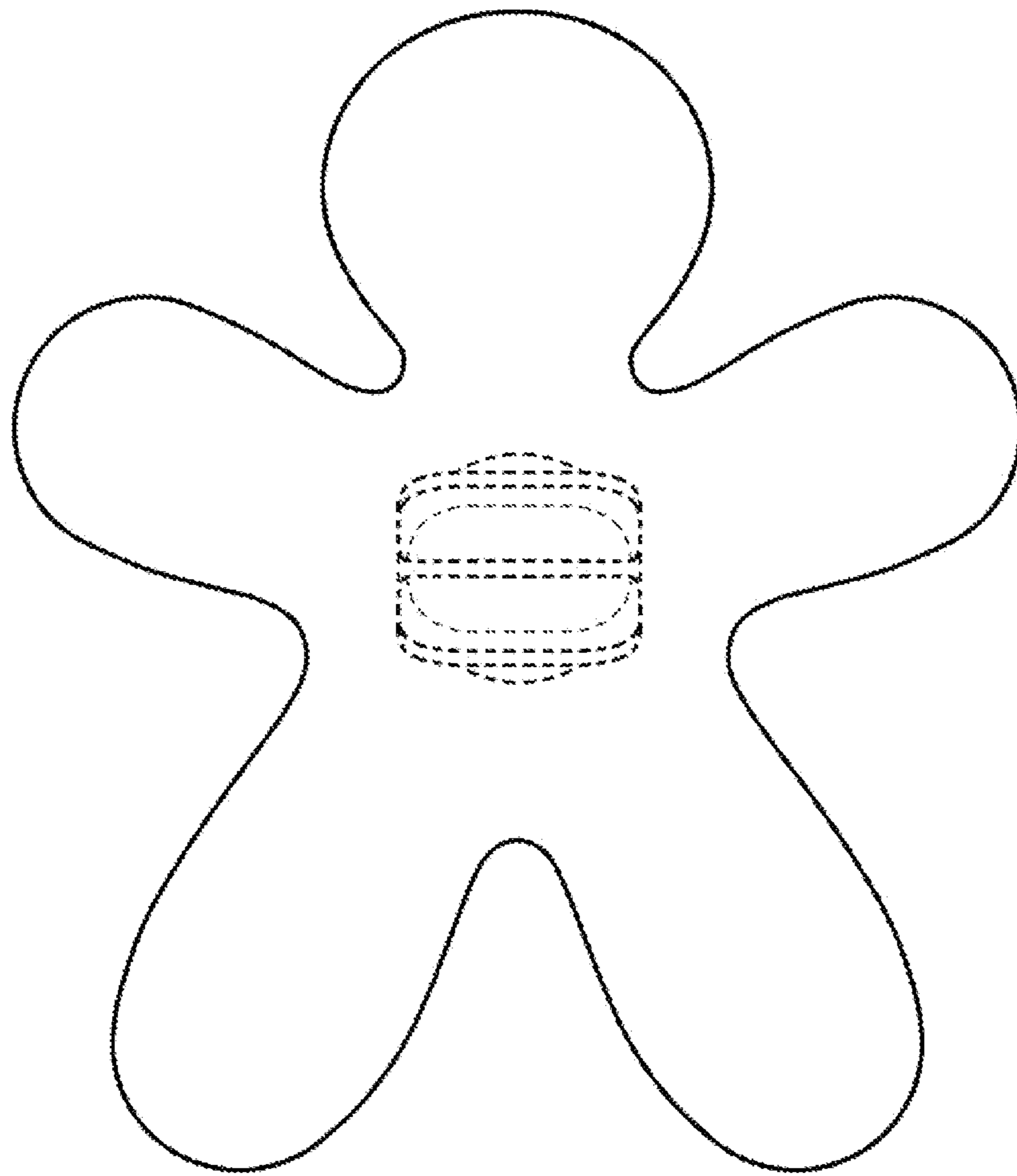

FIG. 2.4

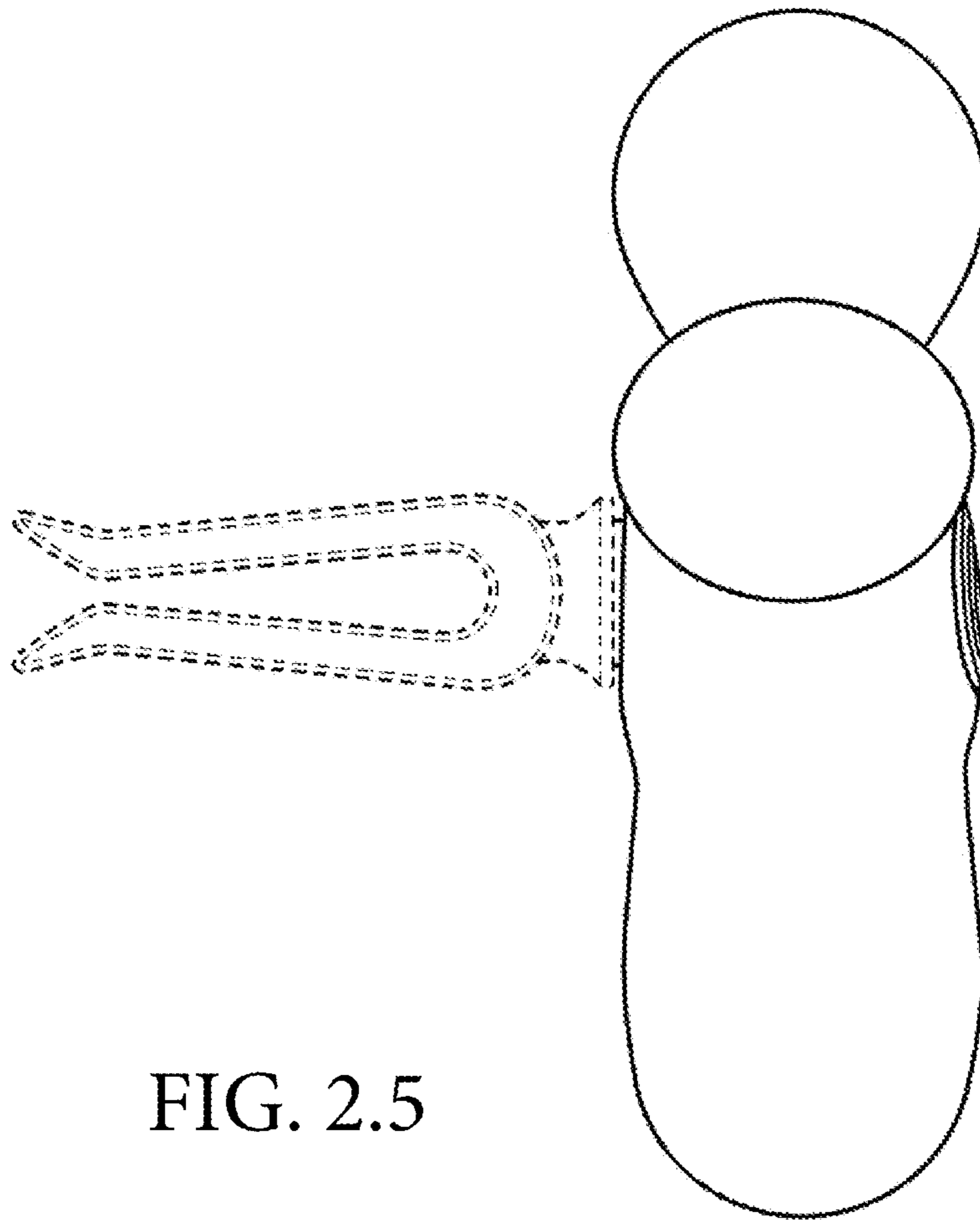

FIG. 2.5

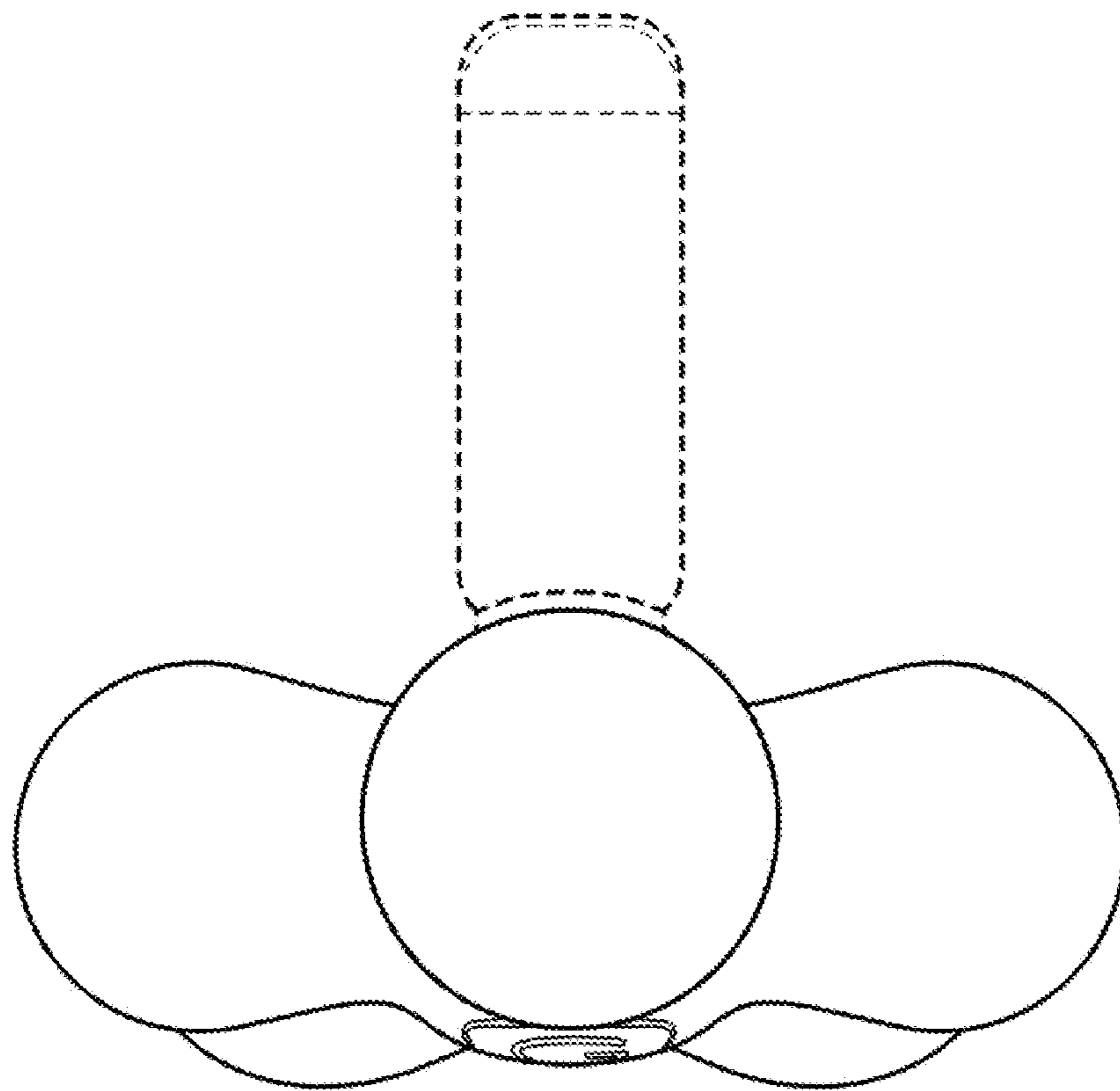

FIG. 2.6

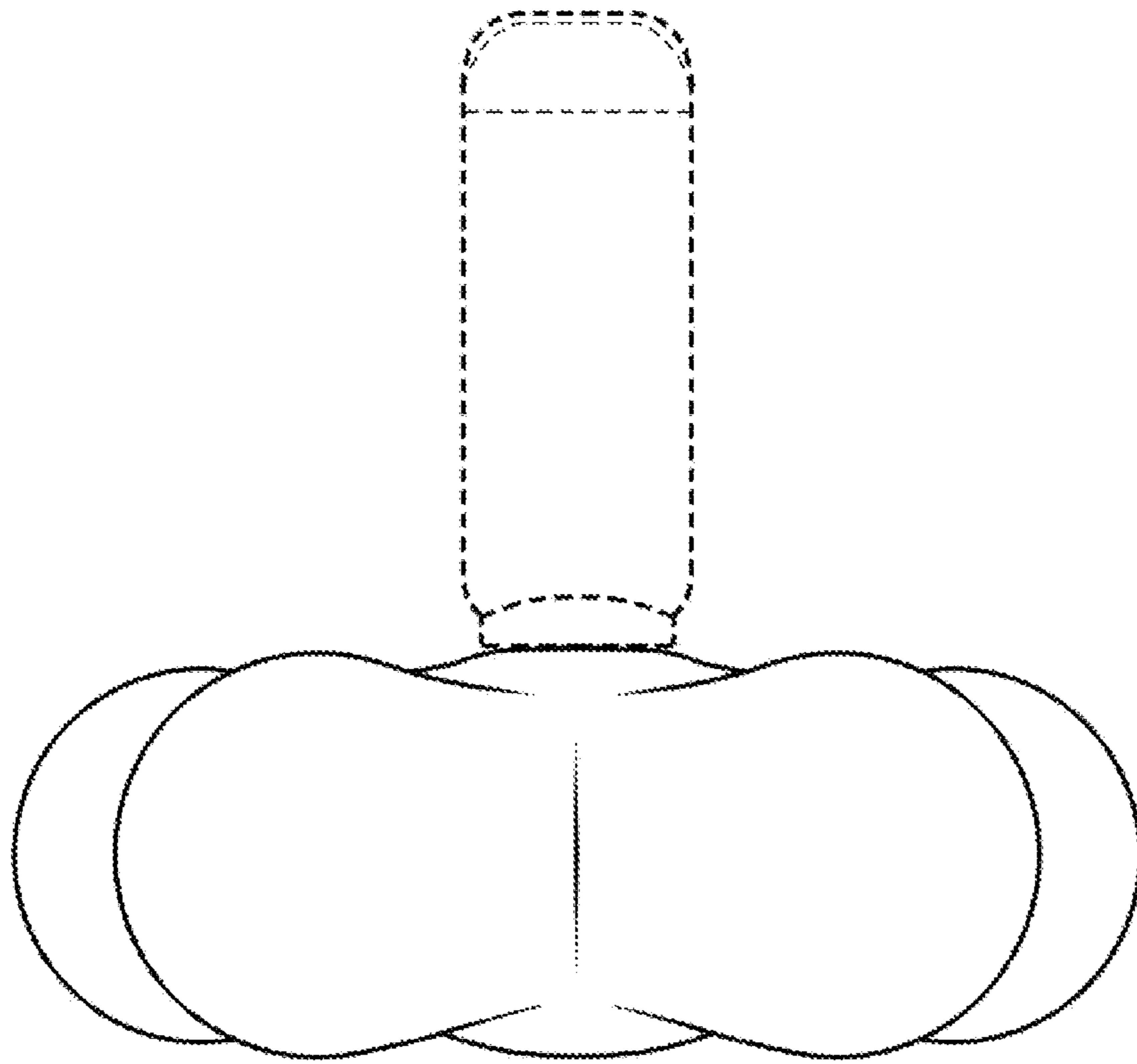

FIG. 2.7

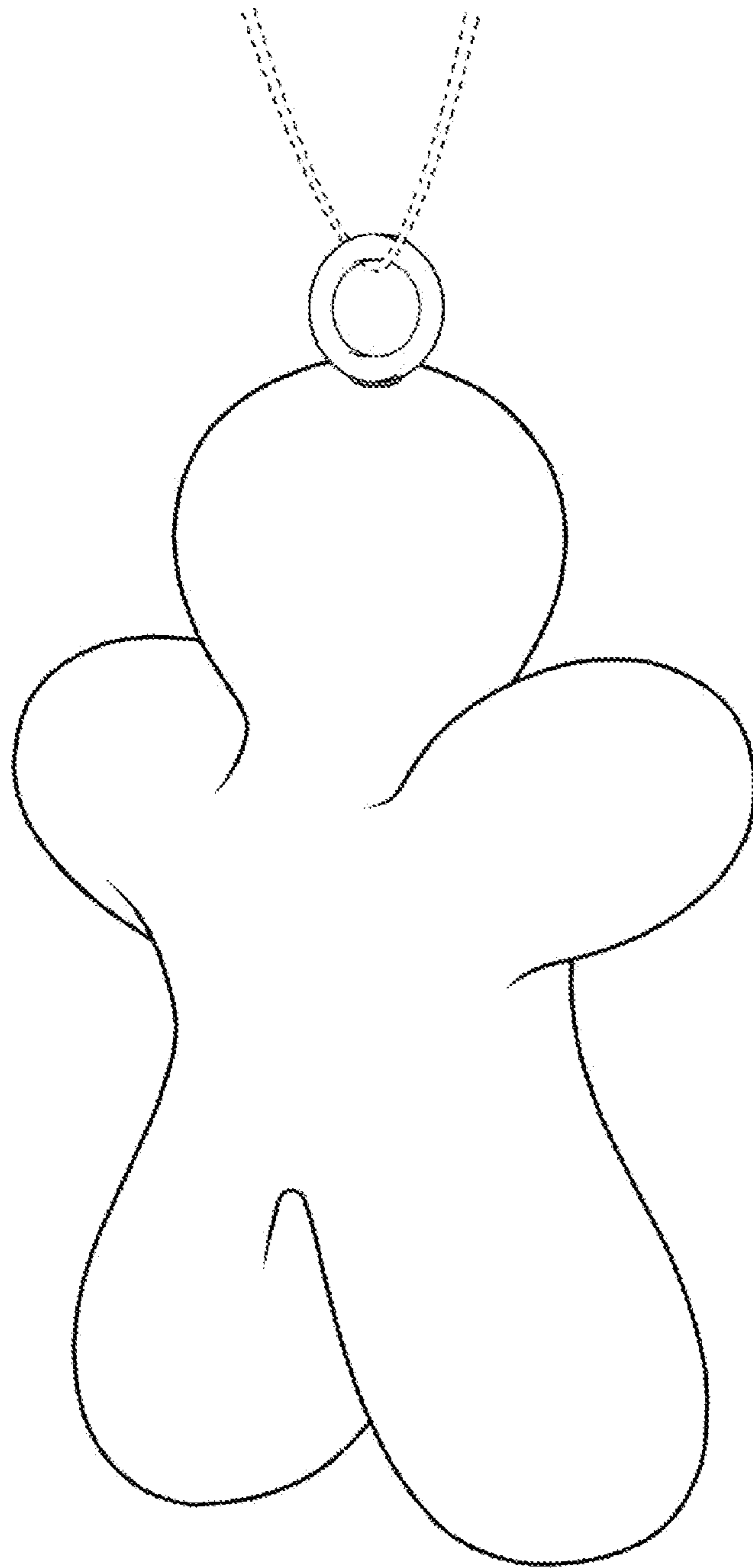

FIG. 3.1



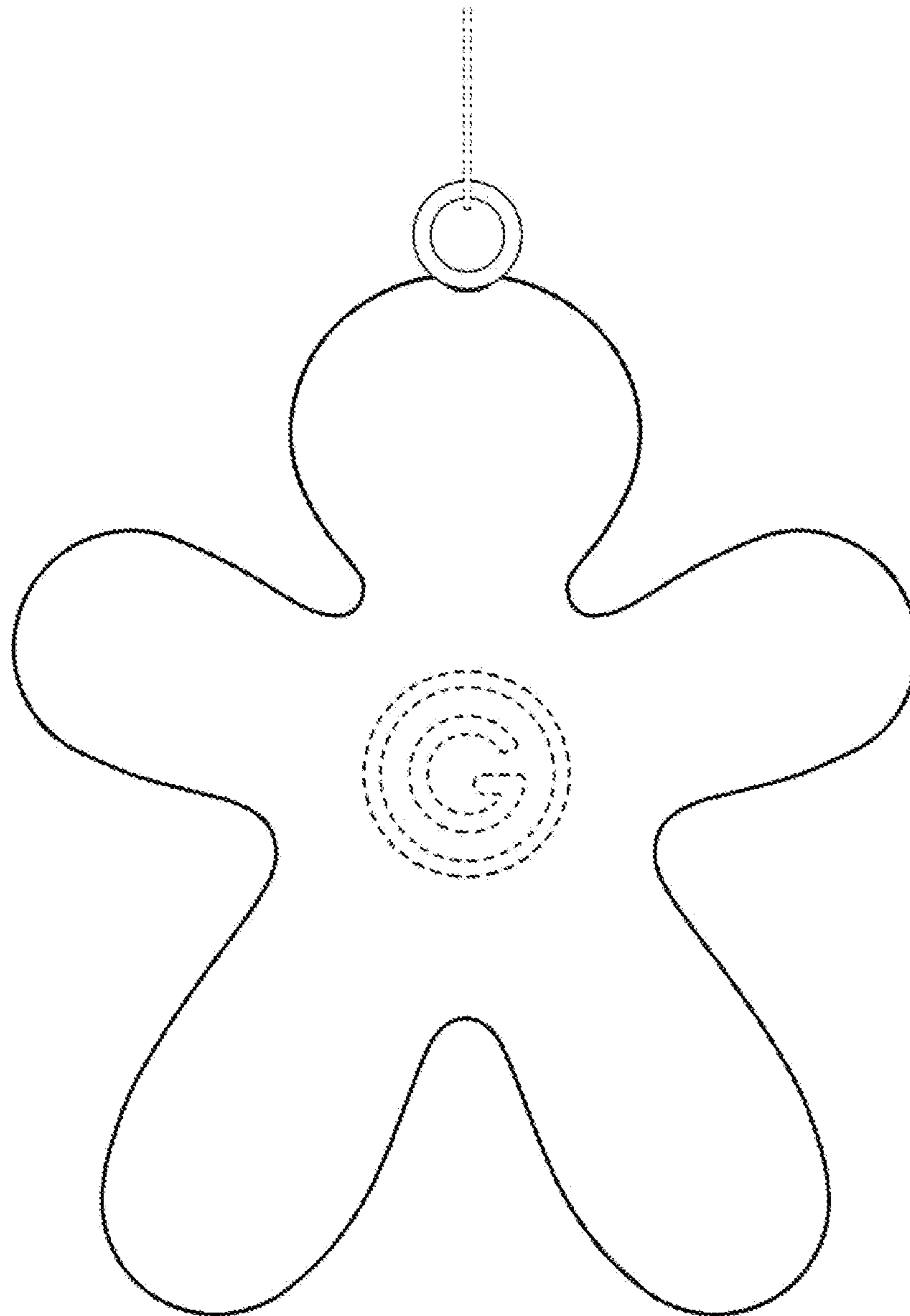

FIG. 3.2

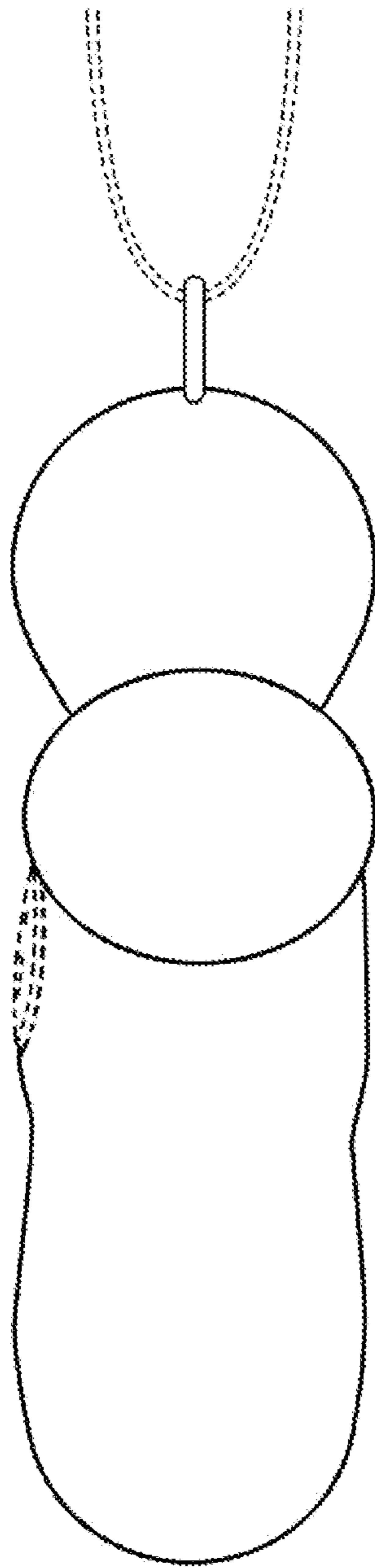

FIG. 3.3

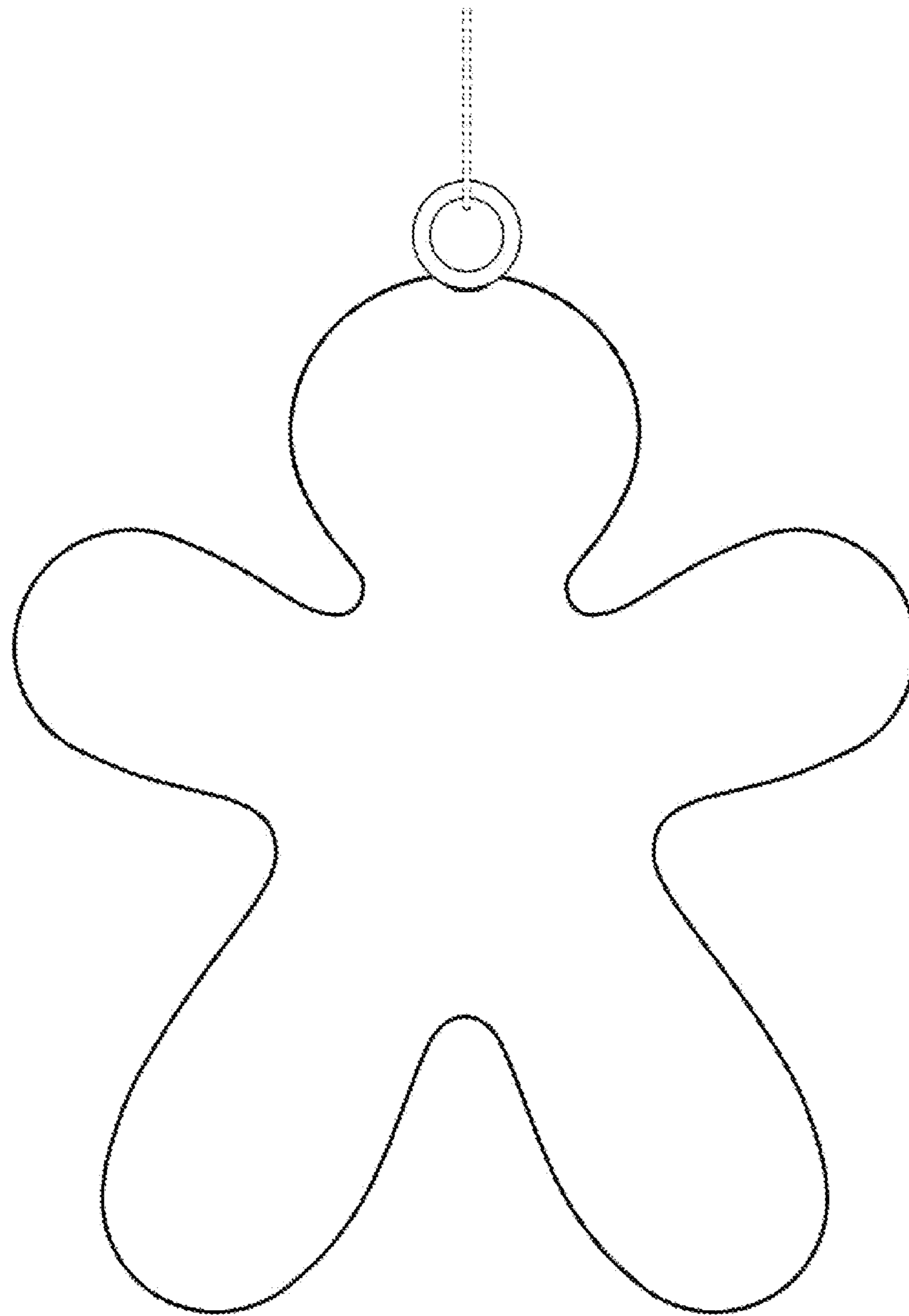

FIG. 3.4

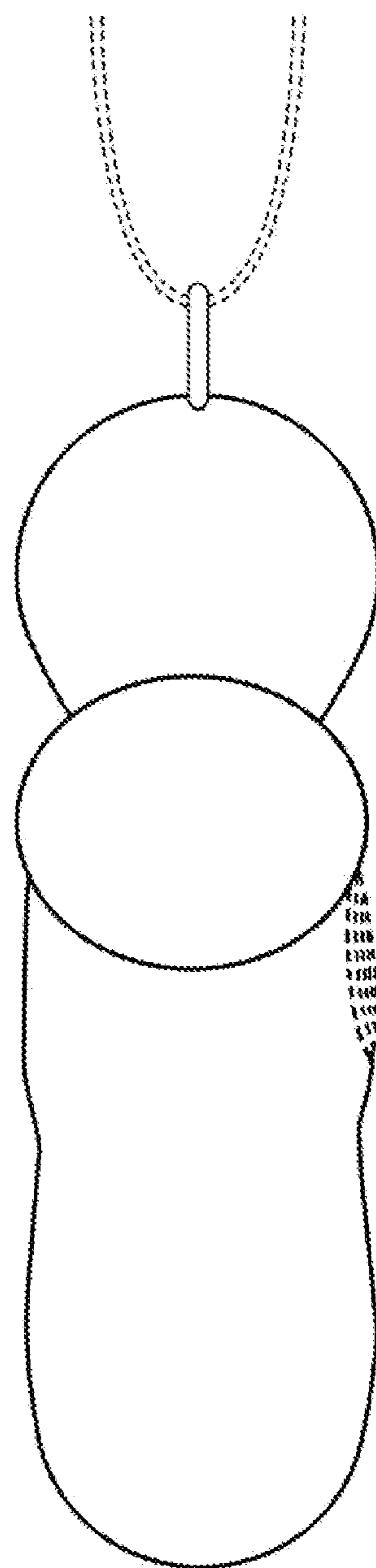

FIG. 3.5

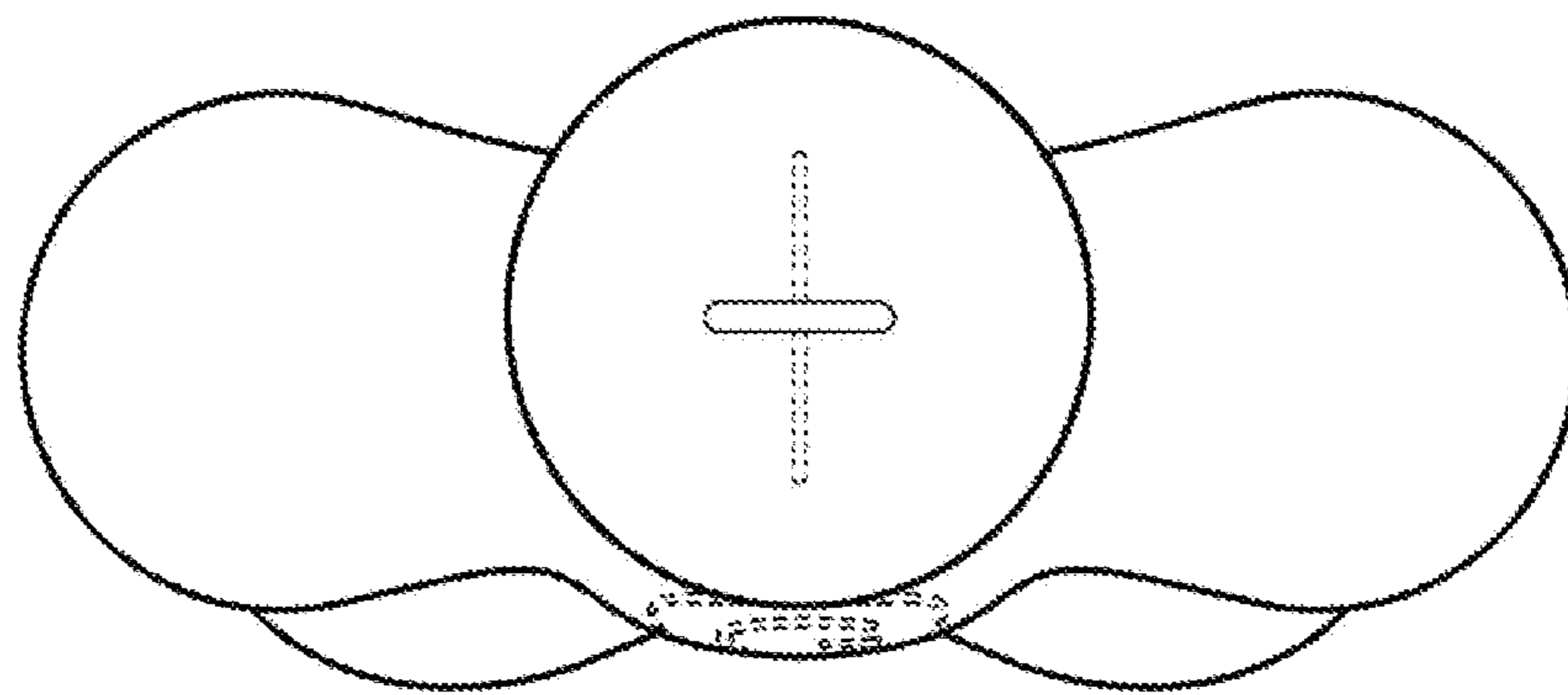

FIG. 3.6

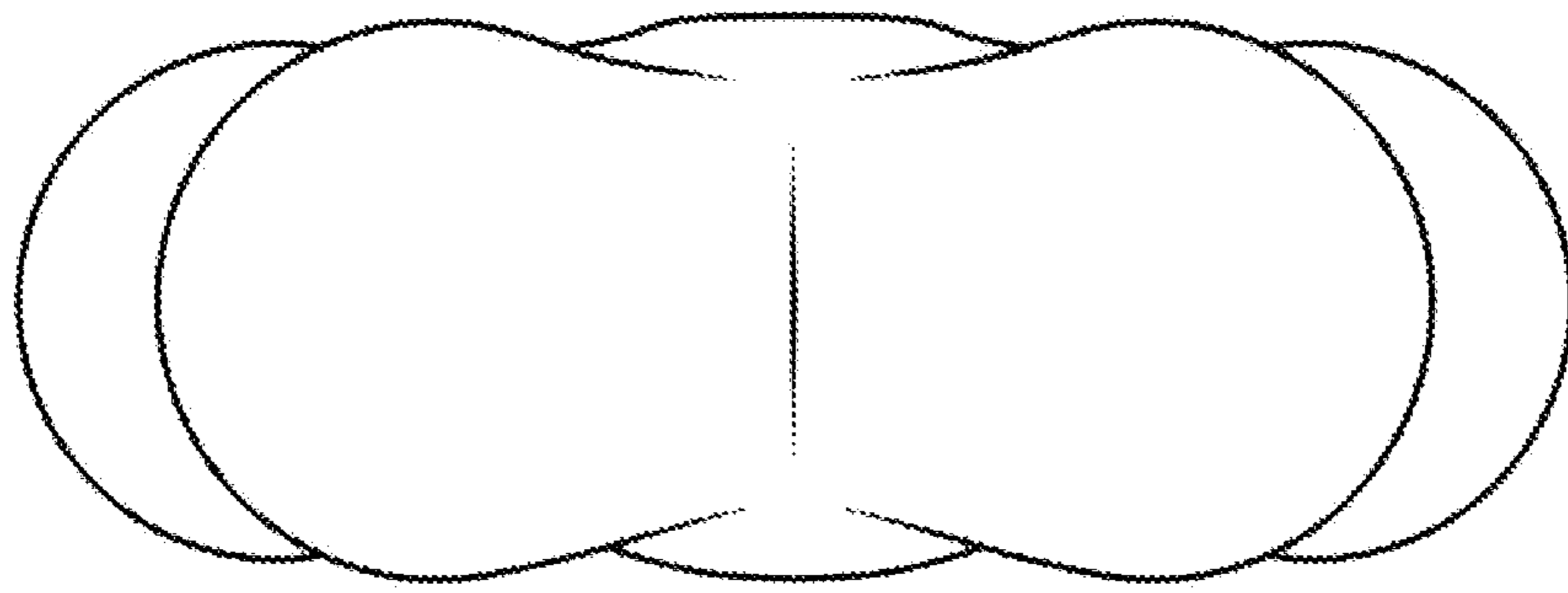

FIG. 3.7