



US00D953492S

(12) **United States Design Patent**  
**Kuang**

(10) **Patent No.:** **US D953,492 S**

(45) **Date of Patent:** **\*\* May 31, 2022**

(54) **FAUCET**

(71) Applicant: **ShunQiao Kuang**, Jiangmen (CN)

(72) Inventor: **ShunQiao Kuang**, Jiangmen (CN)

(\*\*) Term: **15 Years**

(21) Appl. No.: **29/744,390**

(22) Filed: **Jul. 29, 2020**

(51) **LOC (13) Cl.** ..... **23-01**

(52) **U.S. Cl.**  
USPC ..... **D23/238**

(58) **Field of Classification Search**

USPC ..... D23/238, 239, 240, 241, 242, 243, 244,  
D23/245, 246, 247, 248, 249, 250, 251,  
D23/252, 253, 254, 255, 256, 257, 259  
CPC ..... Y10T 137/9464; E03C 1/00; E03C 1/02;  
E03C 1/04; E03C 1/042; E03C 1/044;  
E03C 1/0402; E03C 1/0403; E03C  
1/0405; E03C 1/0412

See application file for complete search history.

(56) **References Cited**

**U.S. PATENT DOCUMENTS**

D567,912 S *	4/2008	Juratovac .....	D23/255
D596,712 S *	7/2009	Schoenherr .....	D23/252
D603,021 S *	10/2009	Roy .....	D23/238
D639,397 S *	6/2011	Fritz .....	D23/255
D777,883 S *	1/2017	Hanna .....	D23/252
D830,517 S *	10/2018	Zhang .....	D23/238
D871,548 S *	12/2019	Tentler .....	D23/238
D873,379 S *	1/2020	Fritz .....	D23/238
D919,052 S *	5/2021	He .....	D23/238

**OTHER PUBLICATIONS**

Amazon, Glanzhaus Modern Brushed Nickel single handle faucet, posted Apr. 10, 2019, [online], [visited Nov. 4, 2021], Internet,

<URL: https://www.amazon.co.uk/GLANZHAUS-Modern-Brushed-Kitchen-Monobloc/dp/B07QLRNG6R/ref> (Year: 2019).\*  
Amazon, Hansgrohe Joleena kitchen faucet, posted Nov. 15, 2019, [online], [visited Nov. 5, 2021], Internet, <URL: https://www.amazon.com/hansgrohe-4793800-Joleena-Pull-Down-15-8-Inches/dp/B081K6F11Y/ref> (Year: 2019).\*  
Amazon, Kelelife Single Handle kitchen sink faucet, posted Sep. 11, 2019, [online], [visited Nov. 5, 2021], Internet, <URL: https://www.amazon.com/Single-Handle-Kitchen-Multifunctional-Sprayer/dp/B07VTL6HSP/ref> (Year: 2019).\*  
Amazon, WOWOW Kitchen Faucets with Pull Down Sprayer, posted May 23, 2019, [online], [visited Mar. 8, 2022], Internet, <URL: https://www.amazon.com/WOWOW-Kitchen-Faucets-Commercial-Stainless/dp/B07MT7VCPJ/ref> (Year: 2019).\*

\* cited by examiner

*Primary Examiner* — Samantha Wood

(57) **CLAIM**

The ornamental design for a faucet, as shown and described.

**DESCRIPTION**

FIG. 1 is a perspective view of a faucet showing my new design;  
FIG. 2 is a front view thereof;  
FIG. 3 is a back view thereof;  
FIG. 4 is a left side view thereof;  
FIG. 5 is a right side view thereof;  
FIG. 6 is a top view thereof; and,  
FIG. 7 is a bottom view thereof.  
The broken lines are included for the purpose of illustrating portions of the article and form no part of the claimed design.

**1 Claim, 7 Drawing Sheets**

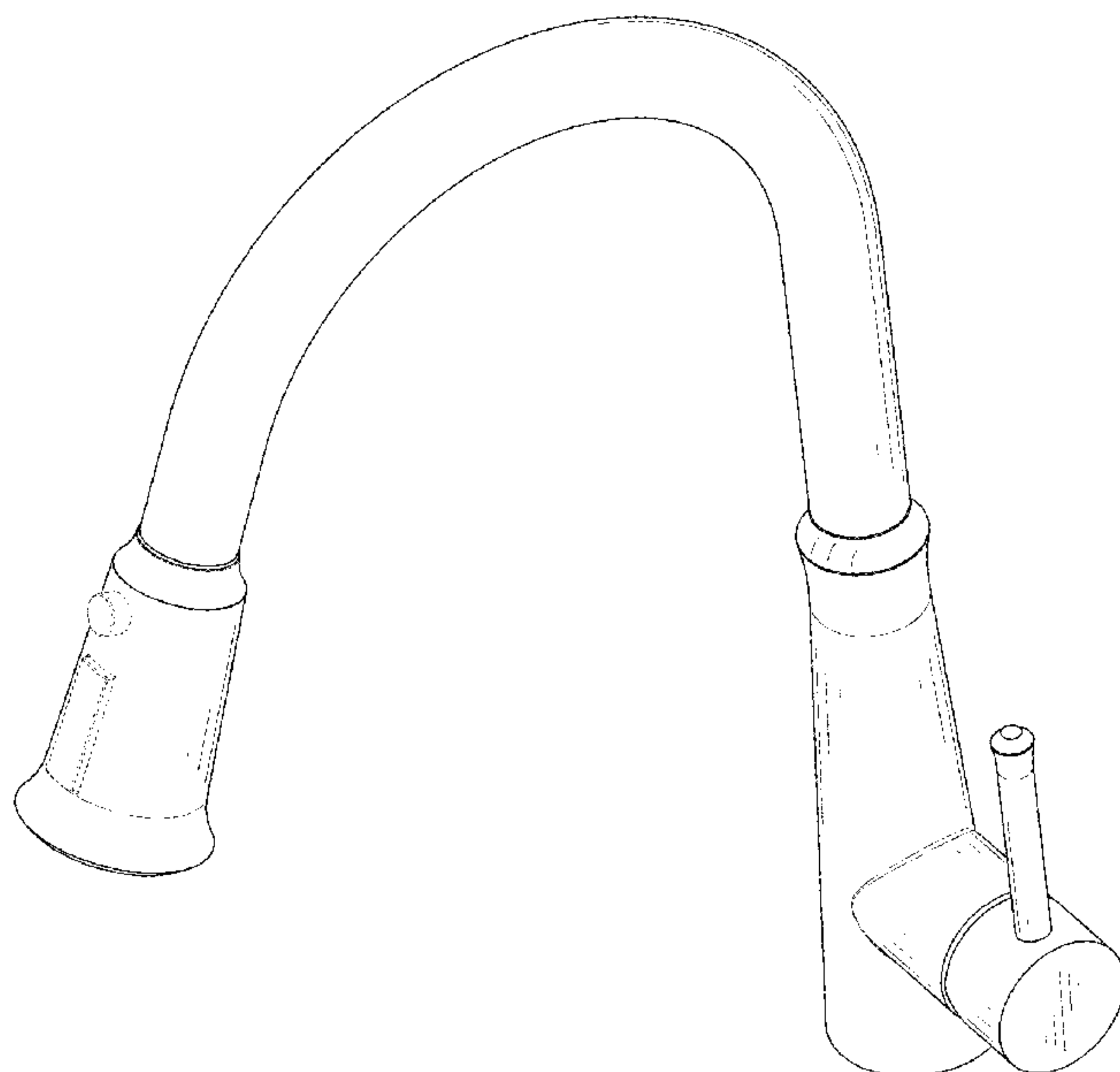

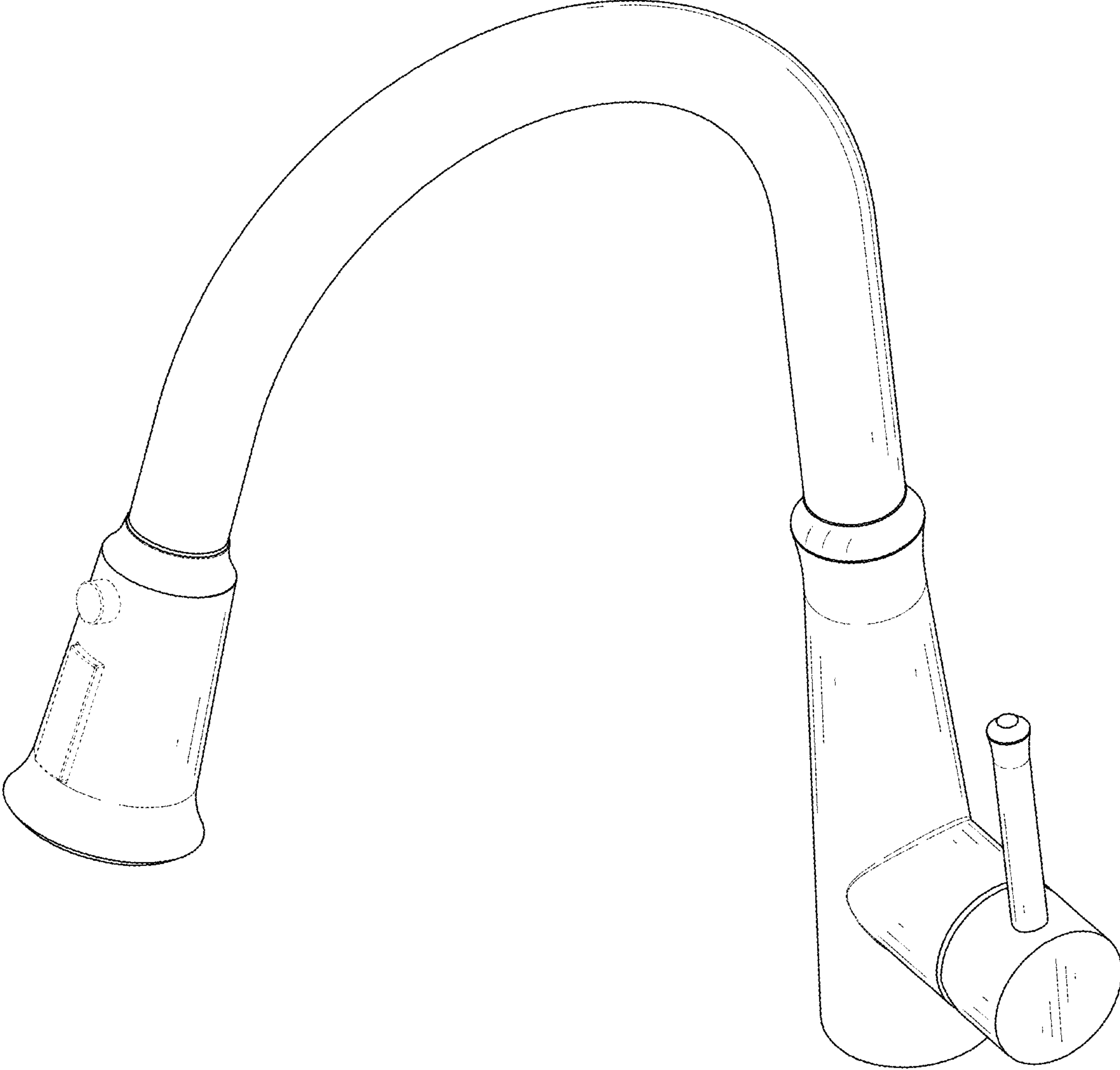

FIG. 1

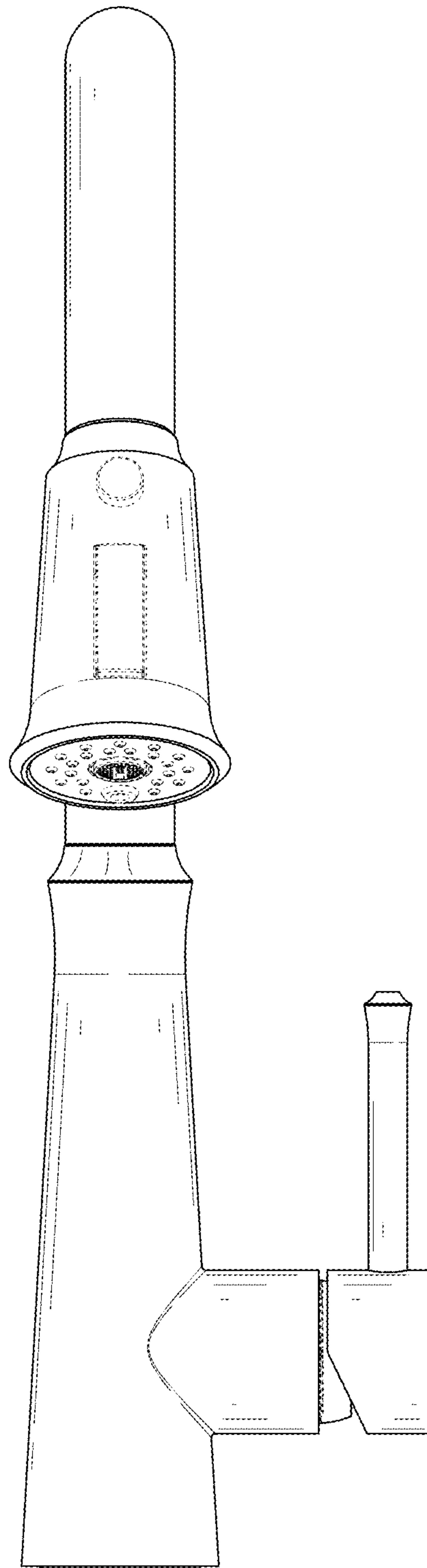

FIG. 2

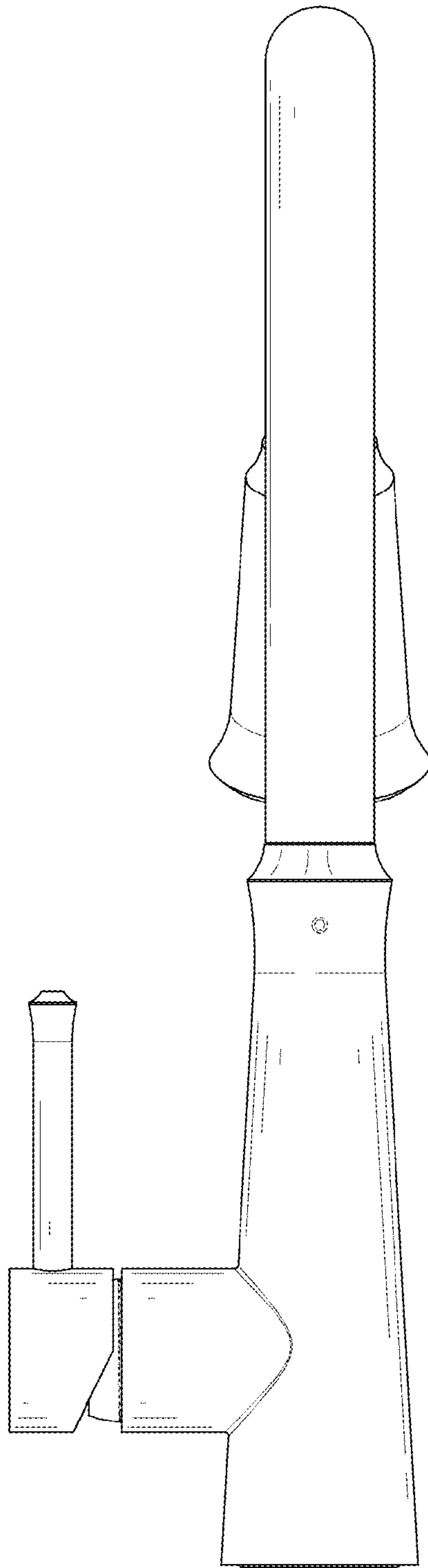

FIG. 3

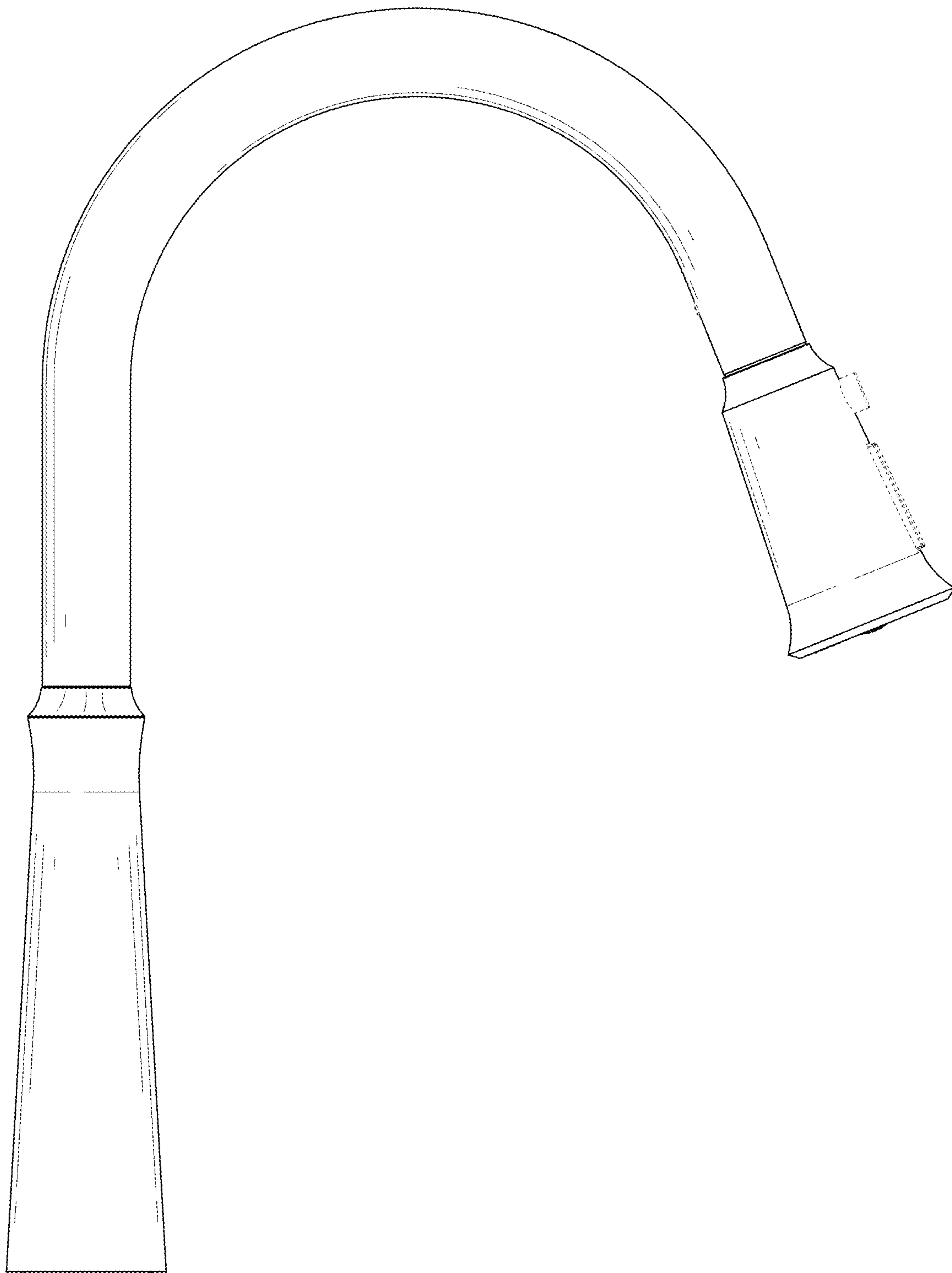

FIG. 4

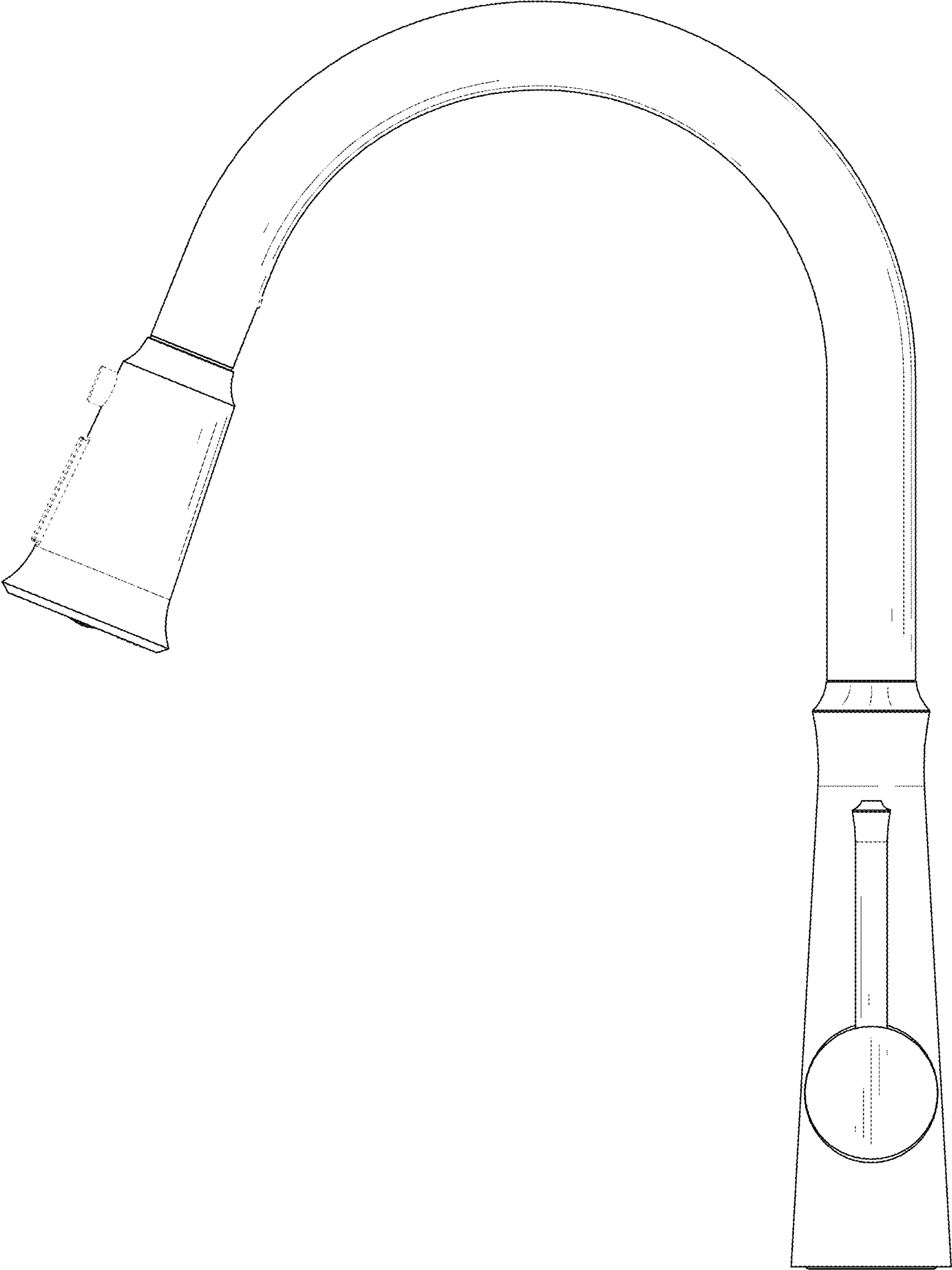

FIG. 5

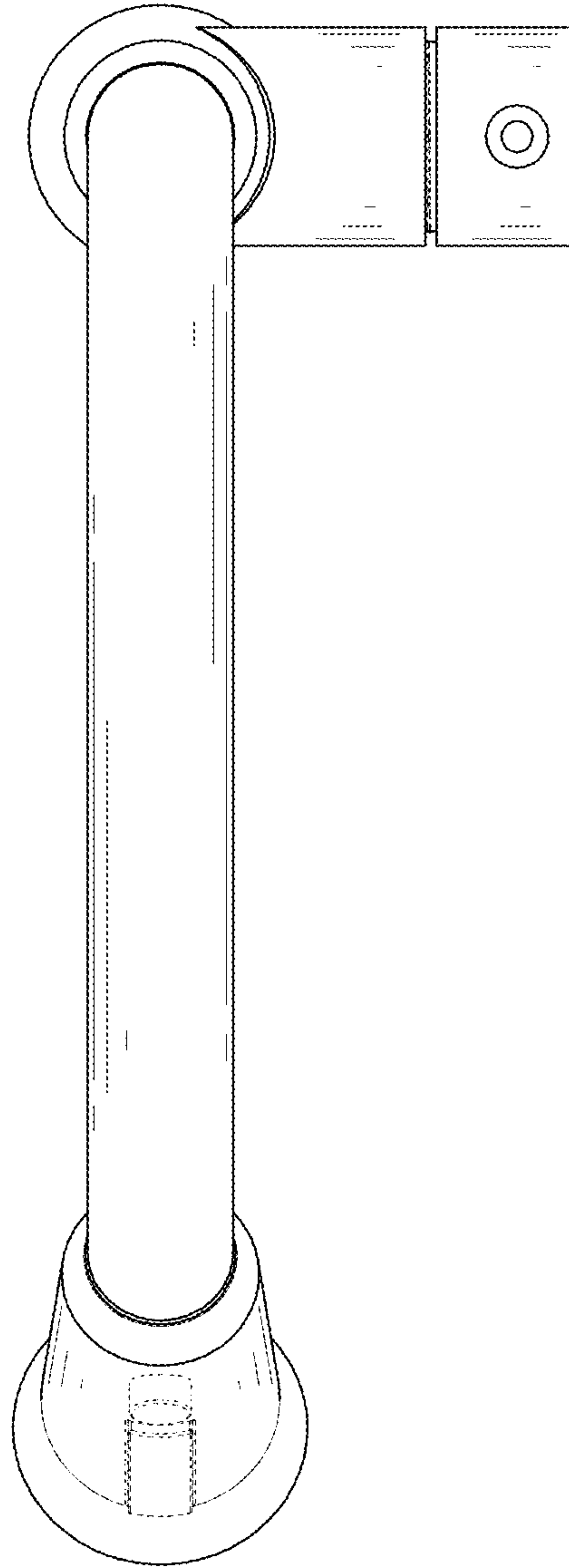

FIG. 6

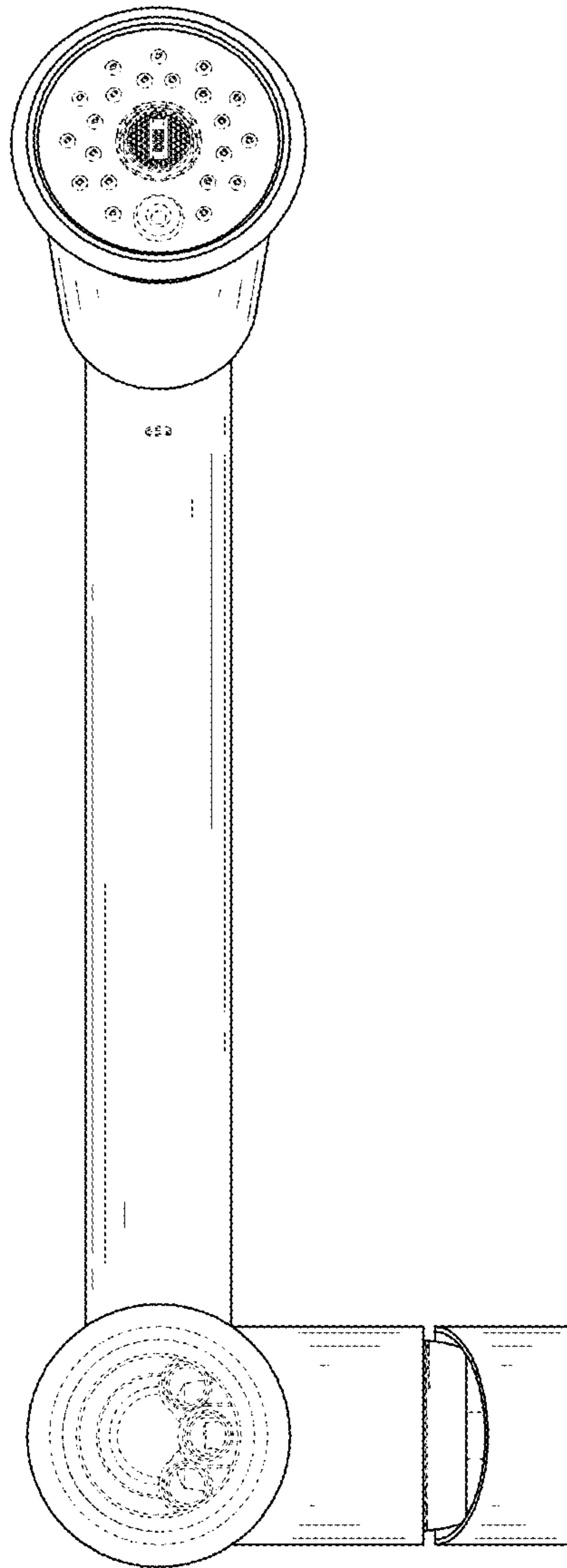

FIG. 7