



US00D953491S

(12) **United States Design Patent** (10) **Patent No.:** **US D953,491 S**  
**Kuang** (45) **Date of Patent:** **\*\* May 31, 2022**

(54) **FAUCET**

FOREIGN PATENT DOCUMENTS

(71) Applicant: **ShunQiao Kuang**, Jiangmen (CN)

CN 202030135402.9 \* 4/2020

(72) Inventor: **ShunQiao Kuang**, Jiangmen (CN)

OTHER PUBLICATIONS

(\*\*) Term: **15 Years**

Youtube, Robinet Cuisine avec Douchette Extensible Mitiguer d'evier Equipe de 2 jets, posted Aug. 15, 2019, [online], [visited Nov. 4, 2021]. Internet, <URL: <https://www.youtube.com/watch?v=ZQaXn3RYvol>> (Year: 2019).\*

(21) Appl. No.: **29/744,387**

Amazon, WOWOW Stainless Steel faucet sink, posted May 4, 2020, [online], [visited Nov. 4, 2021]. Internet, <URL: <https://www.amazon.com/WOWOW-Commercial-Brushed-Kitchen-Stainless/dp/B07V29NZ2K/ref>> (Year: 2020).\*

(22) Filed: **Jul. 29, 2020**

(51) **LOC (13) Cl.** ..... **23-01**

(52) **U.S. Cl.**

USPC ..... **D23/238**

(58) **Field of Classification Search**

USPC ..... D23/238, 239, 240, 241, 242, 243, 244, D23/245, 246, 247, 248, 249, 250, 251, D23/252, 253, 254, 255, 256, 257, 259

CPC ..... Y10T 137/9464; E03C 1/00; E03C 1/02; E03C 1/04; E03C 1/042; E03C 1/044; E03C 1/0402; E03C 1/0403; E03C 1/0405; E03C 1/0412

See application file for complete search history.

\* cited by examiner

*Primary Examiner* — Samantha Wood

(57) **CLAIM**

The ornamental design for a faucet, as shown and described.

**DESCRIPTION**

FIG. 1 is a perspective view of a faucet showing my new design;

FIG. 2 is a front view thereof;

FIG. 3 is a back view thereof;

FIG. 4 is a left side view thereof;

FIG. 5 is a right side view thereof;

FIG. 6 is a top view thereof; and,

FIG. 7 is a bottom view thereof.

The broken lines are included for the purpose of illustrating portions of the faucet and form no part of the claimed design.

(56) **References Cited**

U.S. PATENT DOCUMENTS

D460,150 S *	7/2002	Rexach	.....	D23/238
D469,159 S *	1/2003	Marshall	.....	D23/242
D477,052 S *	7/2003	Kollmann	.....	D23/238
D535,724 S *	1/2007	Zhou	.....	D23/238
D612,015 S *	3/2010	Lammel	.....	D23/238
D871,545 S *	12/2019	Wang	.....	D23/238
D871,548 S *	12/2019	Tentler	.....	D23/238
D934,386 S *	10/2021	Pan	.....	D23/238
2018/0127960 A1 *	5/2018	Yuan	.....	E03C 1/0404

**1 Claim, 7 Drawing Sheets**

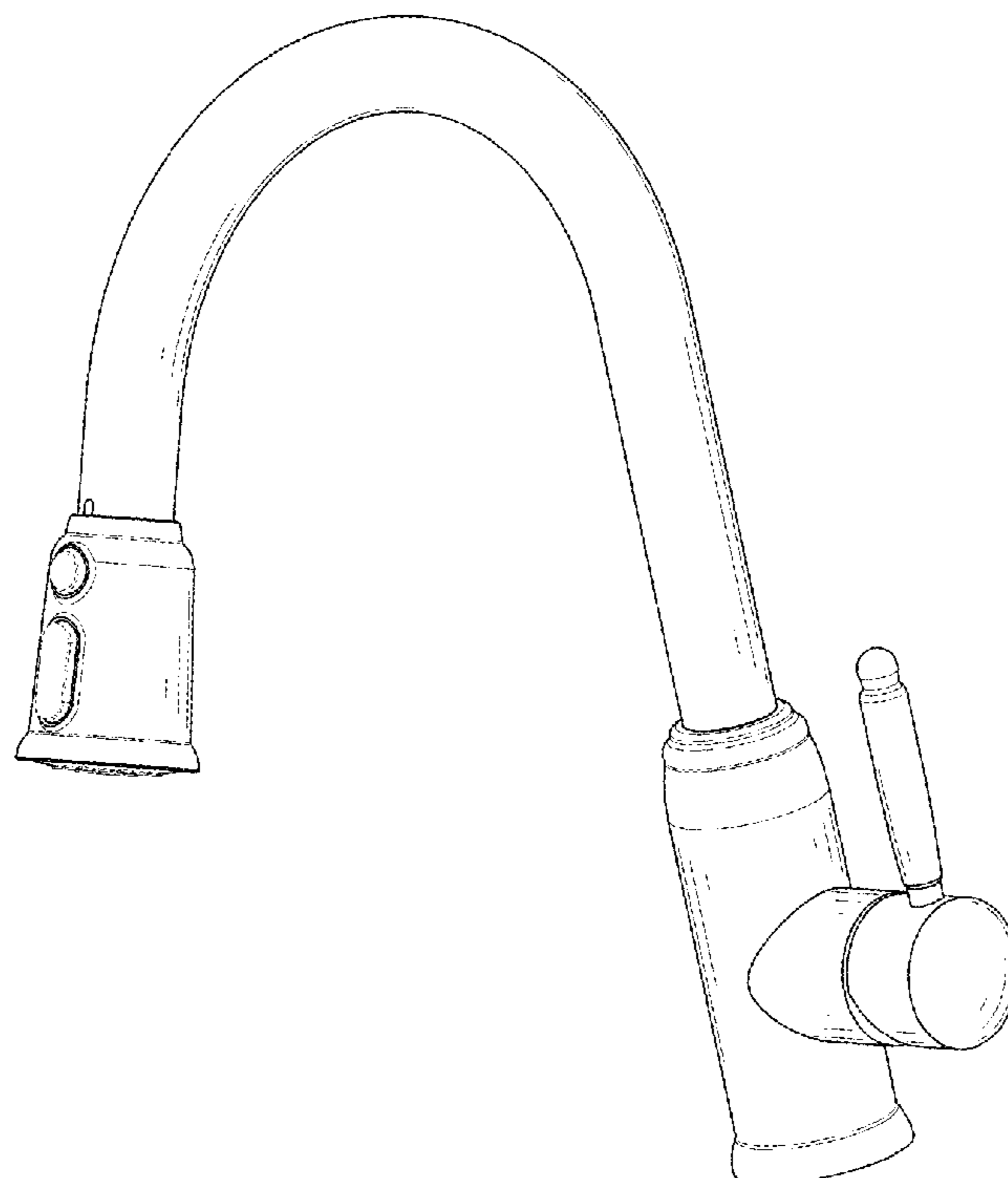

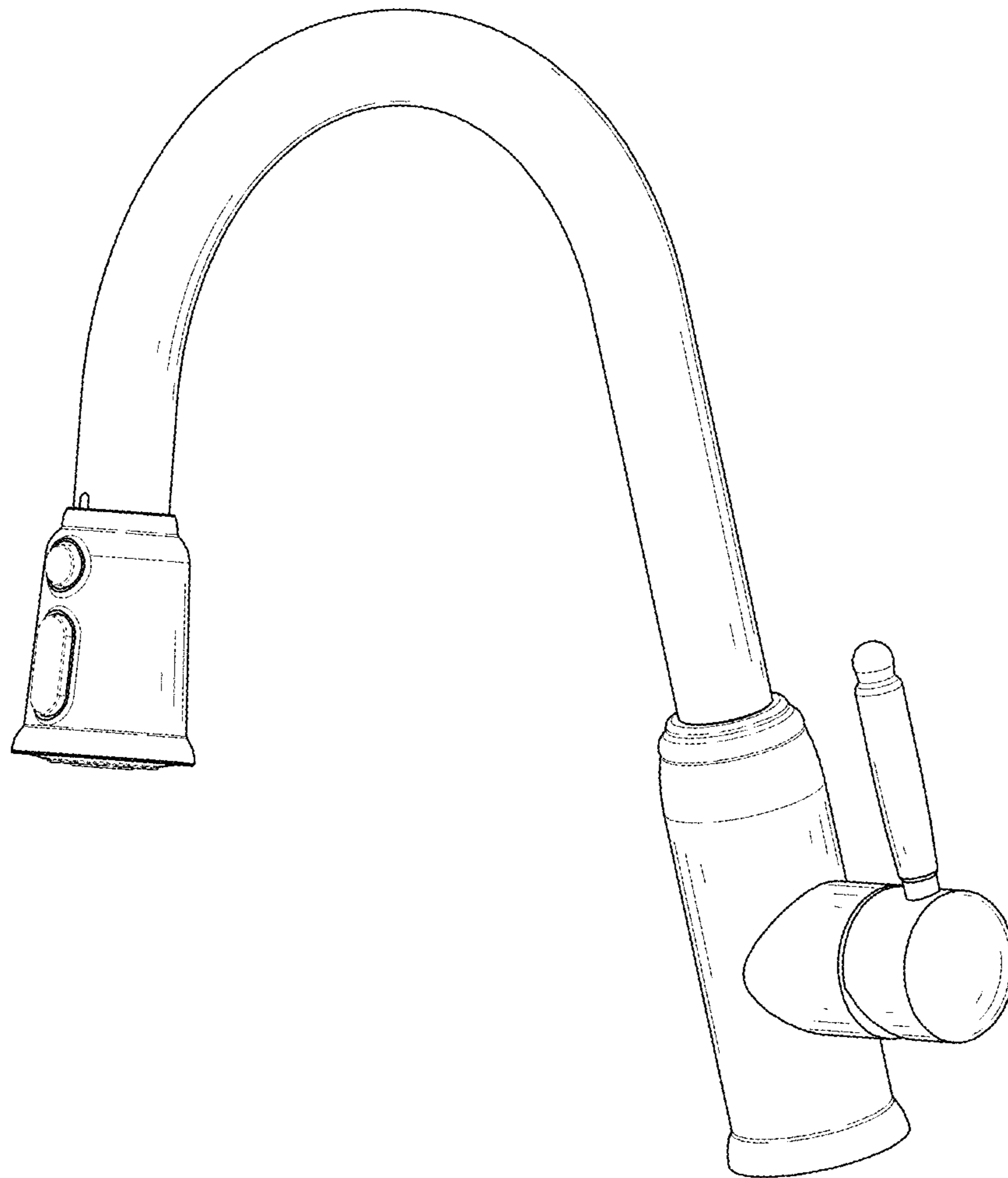

FIG. 1

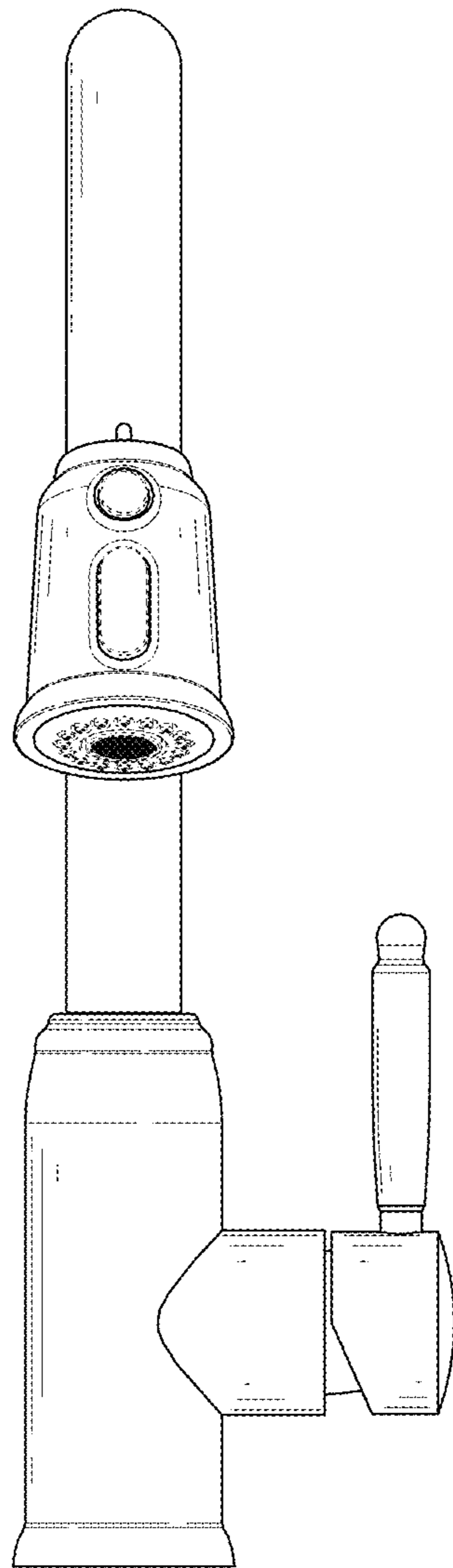

FIG. 2

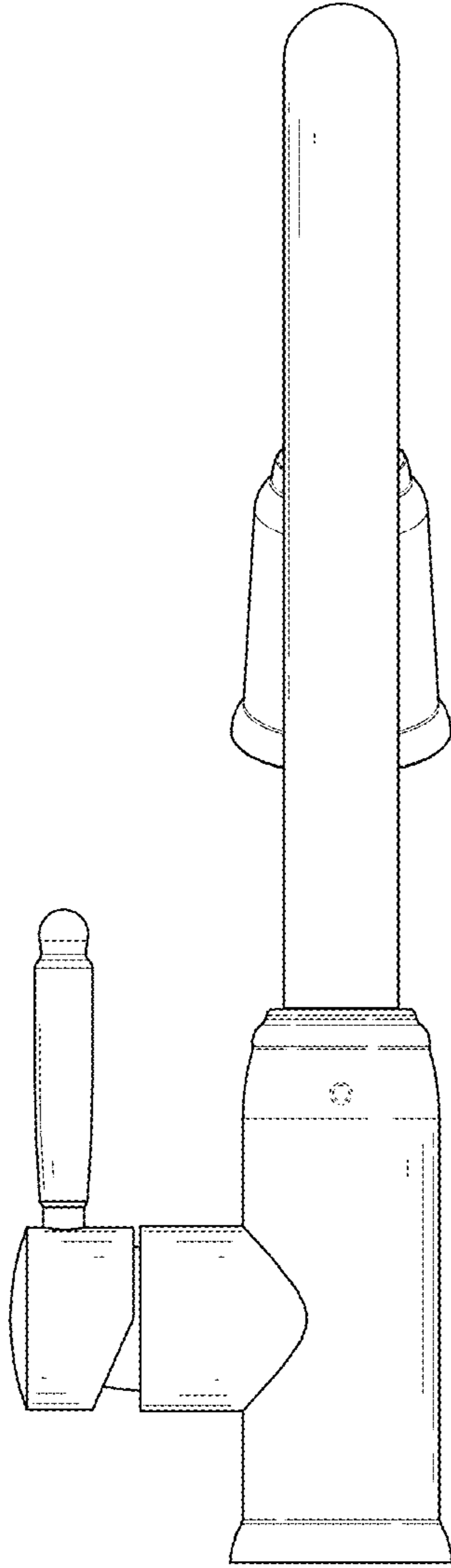

FIG. 3

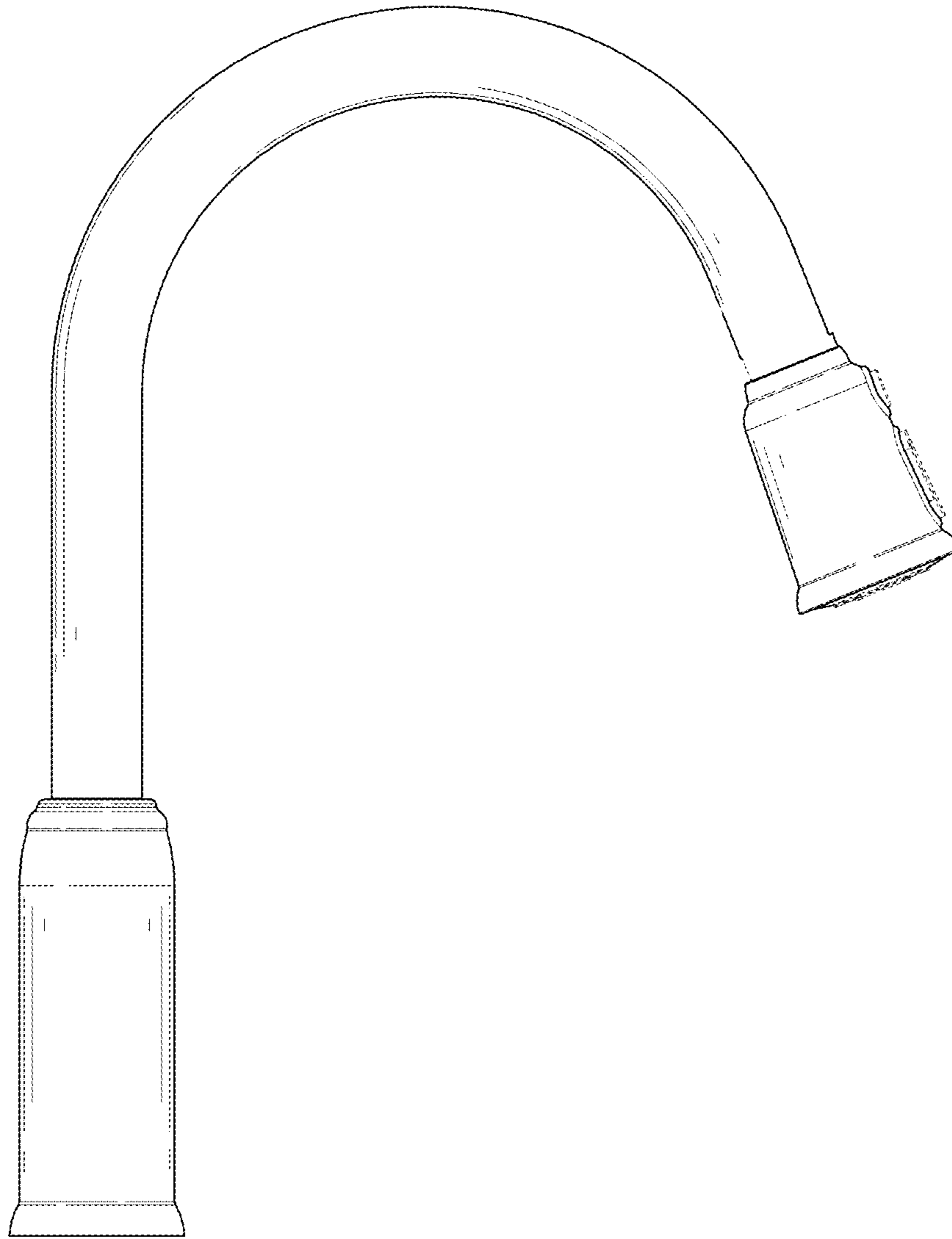

FIG. 4

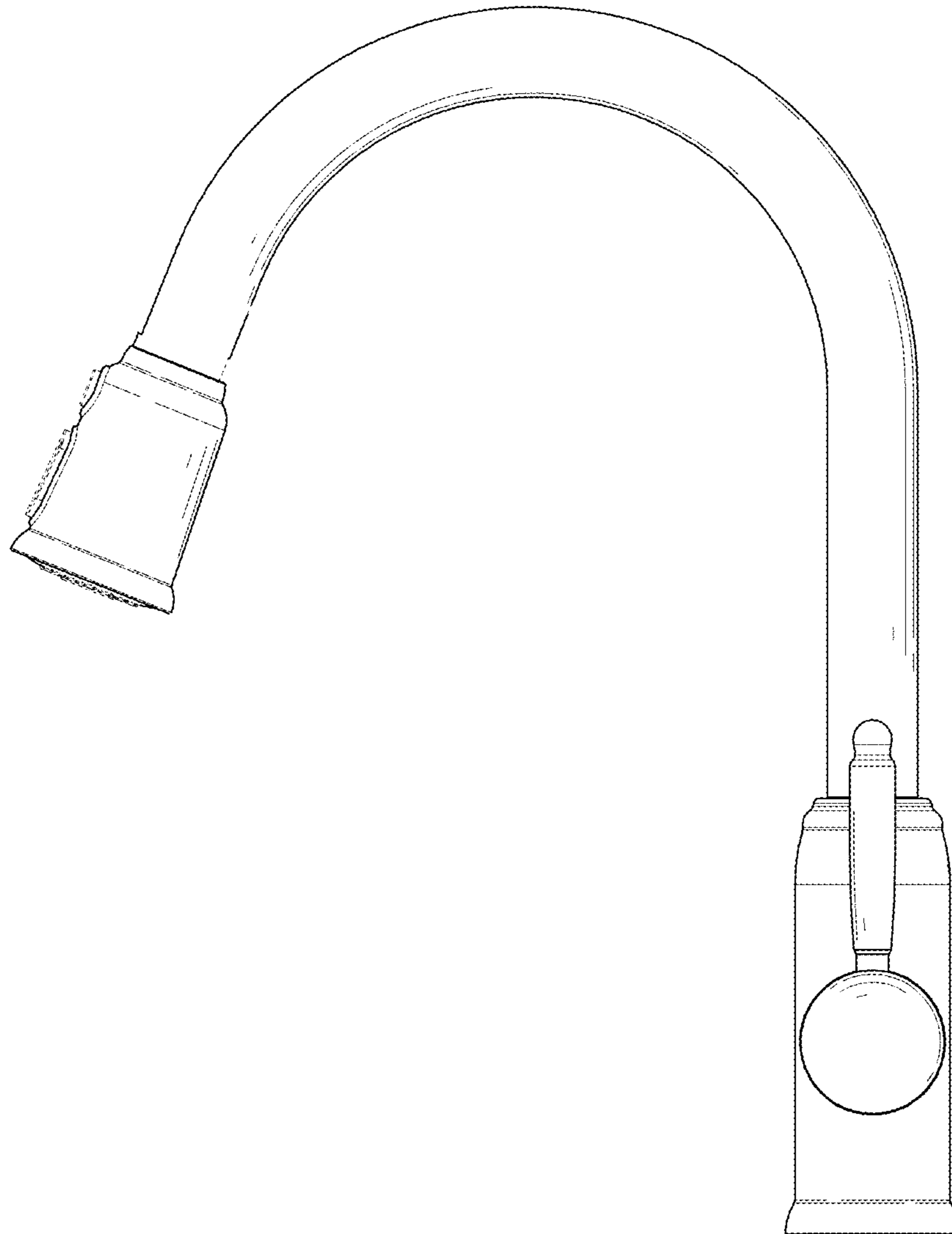

FIG. 5

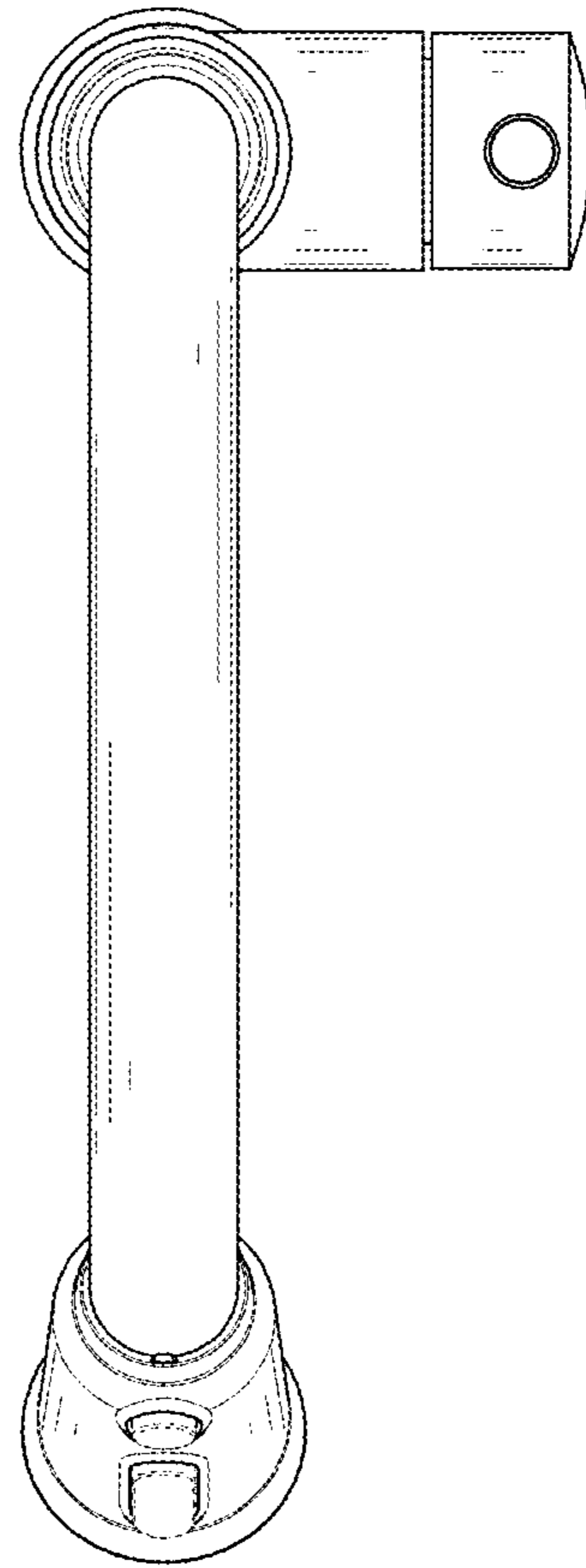

FIG. 6

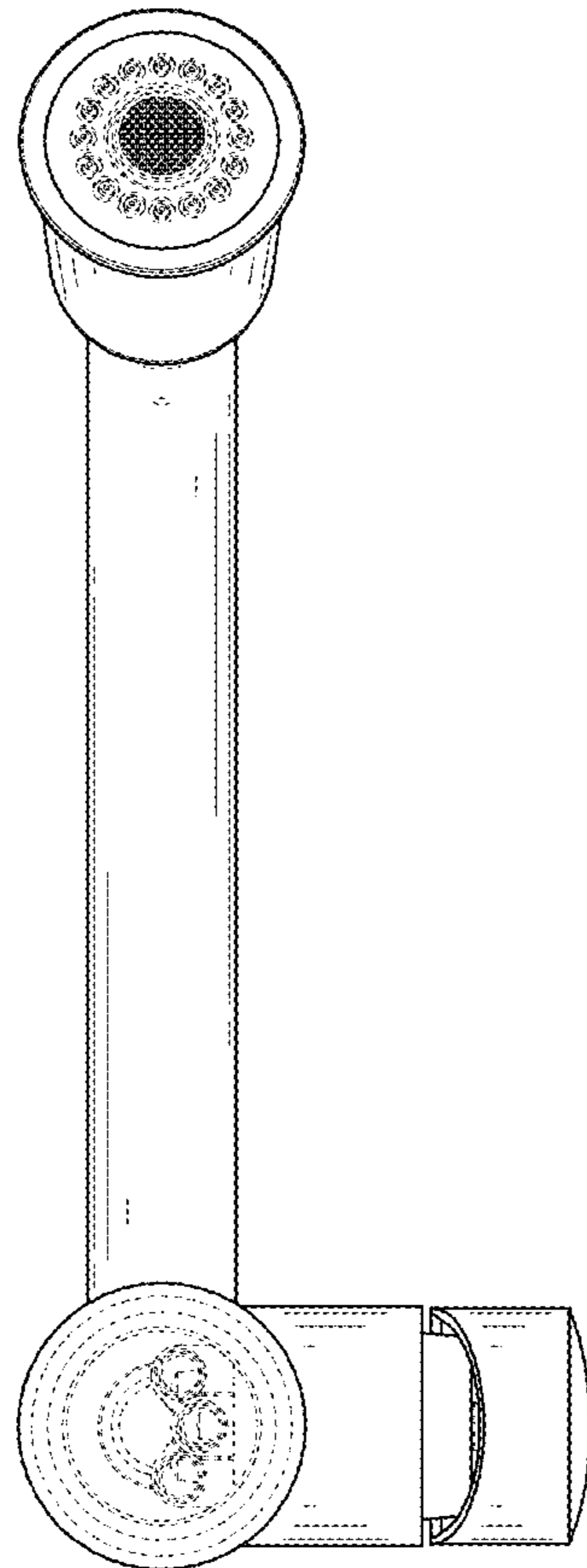

FIG. 7