



US00D953424S

(12) **United States Design Patent**
Takanashi

(10) **Patent No.:** **US D953,424 S**

(45) **Date of Patent:** **** May 31, 2022**

- (54) **PEN**
- (71) Applicant: **mitsubishi pencil company, LIMITED**, Tokyo (JP)
- (72) Inventor: **Kazuhiko Takanashi**, Tokyo (JP)
- (73) Assignee: **mitsubishi pencil company, LIMITED**, Tokyo (JP)
- (**) Term: **15 Years**
- (21) Appl. No.: **29/729,183**
- (22) Filed: **Mar. 24, 2020**
- (30) **Foreign Application Priority Data**
 Sep. 30, 2019 (JP) 2019-021813
- (51) **LOC (13) Cl.** **11-06**
- (52) **U.S. Cl.**
USPC **D19/174; D19/200; D19/904**
- (58) **Field of Classification Search**
USPC D19/115-204; D14/411
CPC . B43K 5/005; B43K 7/12; B43K 8/00; B43K 8/02; B43K 8/04; B43K 8/06; B43K 21/003; B43K 21/006; B43K 21/06
See application file for complete search history.

D474,241 S *	5/2003	Hasegawa	D19/174
D483,065 S *	12/2003	Cetera	D14/411
D507,810 S *	7/2005	Su	D19/117
D546,880 S *	7/2007	Slemp	D19/174
D575,339 S *	8/2008	Daida	D19/172
D592,245 S *	5/2009	Yu	D19/166
D598,953 S *	8/2009	Yu	D19/166
D650,441 S *	12/2011	Ikeda	D19/173
D667,880 S *	9/2012	Zhang	D19/173
D697,970 S *	1/2014	Jin	D19/173
D712,966 S *	9/2014	Ikeda	D19/195
D722,646 S *	2/2015	Wang	D19/174
D724,670 S *	3/2015	Yokoyama	D19/174
D745,926 S *	12/2015	Watase	D19/173
D758,490 S *	6/2016	Shibata	D19/174
D758,491 S *	6/2016	Wang	D19/174
D830,462 S *	10/2018	Takanashi	D19/173
D889,544 S *	7/2020	Jilong	D19/173
D901,586 S *	11/2020	Takanashi	D19/201

* cited by examiner

Primary Examiner — Elizabeth A. Albert

(74) *Attorney, Agent, or Firm* — Andrew F. Young; Nolte Lackenbach Siegel

(57) **CLAIM**

The ornamental design for a pen, as shown and described.

DESCRIPTION

FIG. 1 is a perspective view of a pen showing my new design;
 FIG. 2 is a front elevational view thereof;
 FIG. 3 is a left side elevational view thereof;
 FIG. 4 is a right side elevational view thereof;
 FIG. 5 is a rear elevational view thereof;
 FIG. 6 is a top plan view thereof; and,
 FIG. 7 is a bottom plan view thereof.

1 Claim, 4 Drawing Sheets

- (56) **References Cited**
 U.S. PATENT DOCUMENTS
 D280,421 S * 9/1985 Giugiaro D19/170
 D363,084 S * 10/1995 Hollington D19/174
 D388,825 S * 1/1998 Kouda D19/172
 D456,846 S * 5/2002 Pellisa Beneyto D19/173
 D463,821 S * 10/2002 Nishida D19/174
 D469,123 S * 1/2003 Briggl D19/174

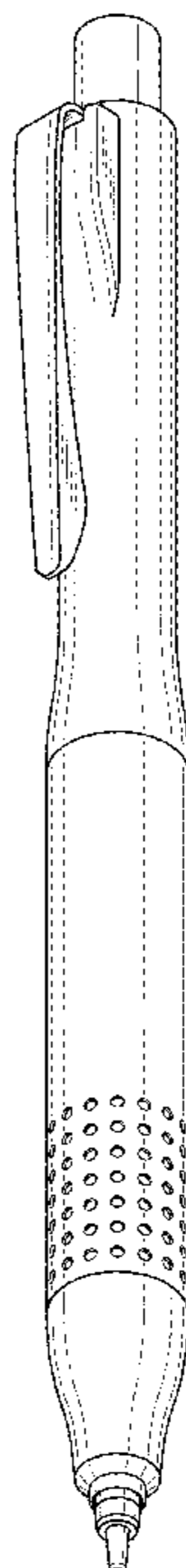

FIG. 1

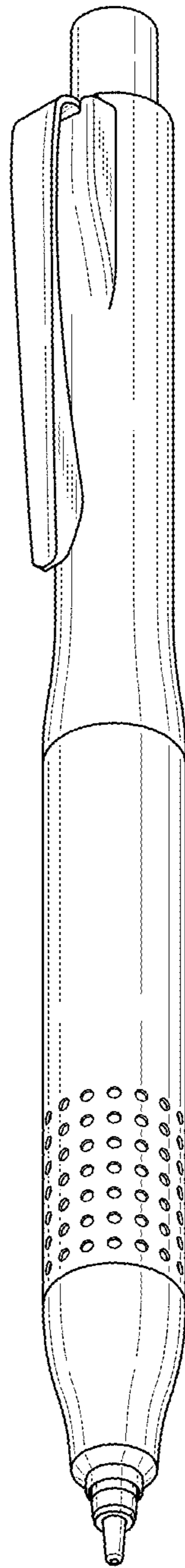

FIG. 2

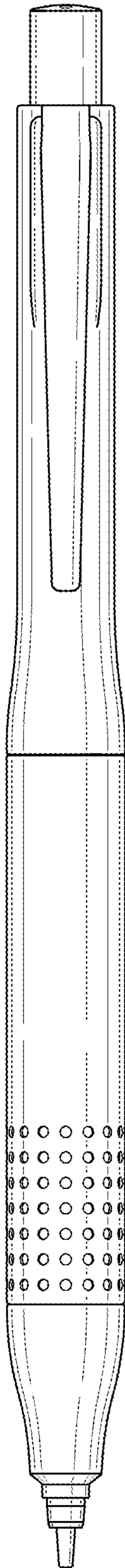

FIG. 3

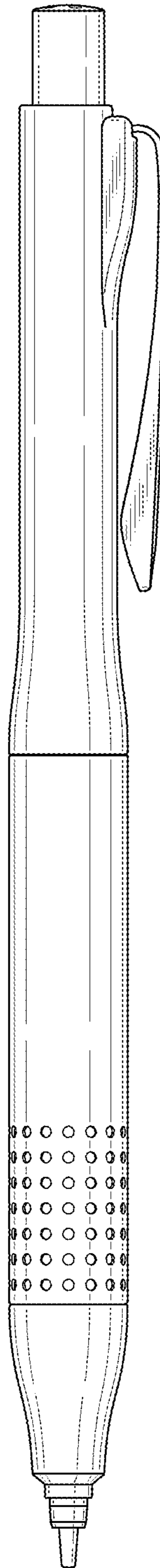

FIG. 4

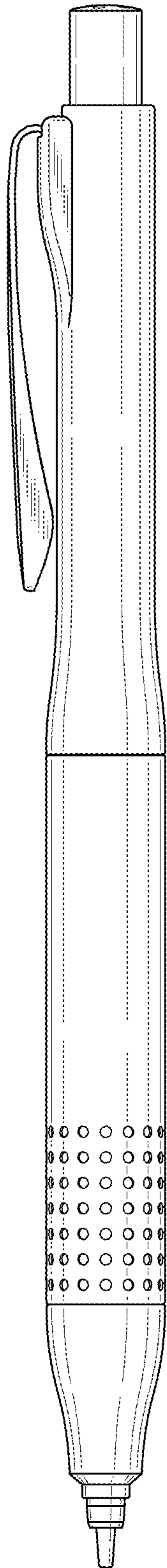

FIG. 5

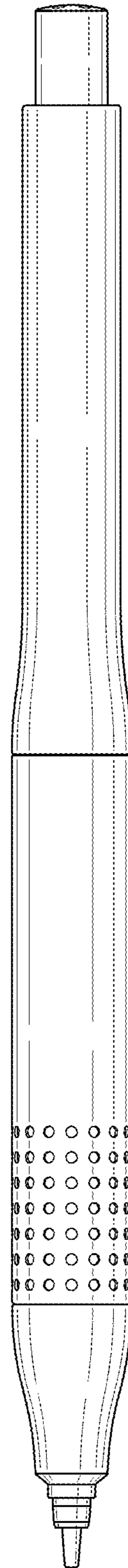

FIG. 6

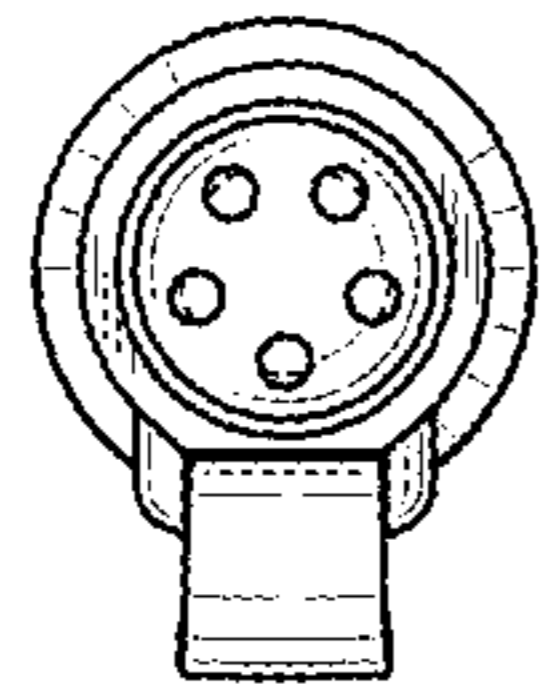

FIG. 7

