



US00D953320S

(12) **United States Design Patent**
Chen et al.

(10) **Patent No.: US D953,320 S**
(45) **Date of Patent: ** May 31, 2022**

(54) **INFORMATION HANDLING SYSTEM**

FOREIGN PATENT DOCUMENTS

(71) Applicant: **Dell Products L.P.**, Round Rock, TX (US)

KR 300659368.0000 * 10/2013
WO WO-D209533-002 * 8/2020

(Continued)

(72) Inventors: **Shih-Heng Chen**, Taipei (TW); **Joshua Young Probst**, Austin, TX (US); **Jason T. Minehart**, Cedar Park, TX (US)

OTHER PUBLICATIONS

(73) Assignee: **Dell Products L.P.**, Round Rock, TX (US)

Alienware M15 Ryzen Edition R5 Gaming Laptop, Dell, dell.com, author and date not listed © 2021 Dell, online, site visited May 19, 2021. Available URL: <https://www.dell.com/en-us/work/shop/dell-laptops-and-notebooks/alienware-m15-ryzen-edition-r5-gaming-laptop/spd/alienware-m15-r5-laptop/wnm1> (Year: 2021).*

(**) Term: **15 Years**

(21) Appl. No.: **29/692,124**

Primary Examiner — Sandra Snapp

(22) Filed: **May 22, 2019**

Assistant Examiner — Altaira J. Swangin

(51) **LOC (13) Cl.** **14-02**

(74) *Attorney, Agent, or Firm* — Zagorin Cave LLP;
Robert W. Holland

(52) **U.S. Cl.**

USPC **D14/315**

(58) **Field of Classification Search**

USPC D14/203.4, 247, 315–327, 331, 345–346,
D14/371–372, 376–377, 391–399, 401,
D14/429, 434, 440, 455–457, 477, 507,
D14/441; D21/324, 409, 512, 515;
D24/158–159, 186

CPC B41J 3/36; G06F 1/1616; G06F 1/1643

See application file for complete search history.

(57) **CLAIM**

We claim the ornamental design for an information handling system, as shown and described.

DESCRIPTION

FIG. 1 is a front perspective view of the information handling system comprising the present invention; FIG. 2 is a front elevation view thereof; FIG. 3 is a rear elevation view thereof; FIG. 4 is a right side view thereof; FIG. 5 is a left side view thereof; FIG. 6 is a top view thereof; FIG. 7 is a bottom view thereof; and, FIG. 8 is a front open perspective view thereof. The even-dash broken lines shown in the drawings represent portions of the information handling system, and form no part of the claimed design. The dash-dot broken lines adjacent to the shaded areas are boundaries of the claimed design and form no part thereof.

(56) **References Cited**

U.S. PATENT DOCUMENTS

| | | | | |
|--------------|---------|--------------|-------|---------|
| D491,178 S * | 6/2004 | Kataoka | | D14/318 |
| D578,523 S * | 10/2008 | Yoon | | D14/319 |
| D590,824 S * | 4/2009 | Kurosawa | | D14/315 |
| D658,171 S * | 4/2012 | Masui | | D14/318 |
| D674,793 S * | 1/2013 | Chen | | D14/315 |
| D695,287 S * | 12/2013 | Chang | | D14/315 |
| D705,219 S * | 5/2014 | Martin | | D14/315 |
| D705,222 S * | 5/2014 | Chang et al. | | D14/315 |
| D716,947 S * | 11/2014 | Ogura | | D24/158 |
| D729,229 S * | 5/2015 | Kurimoto | | D14/320 |
| D737,268 S * | 8/2015 | Rivera | | D14/315 |
| D749,561 S * | 2/2016 | Okuley | | D14/315 |

(Continued)

1 Claim, 5 Drawing Sheets

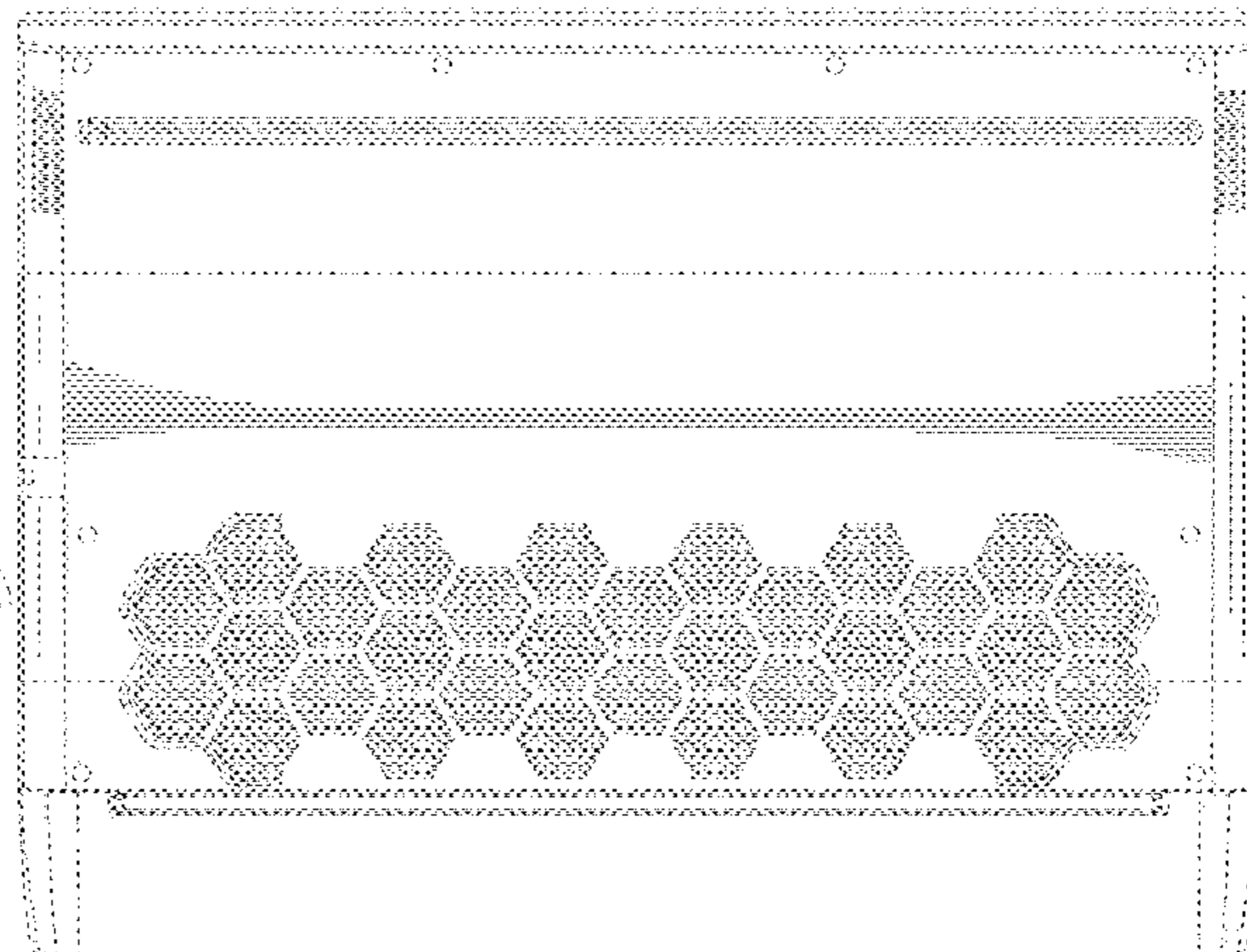
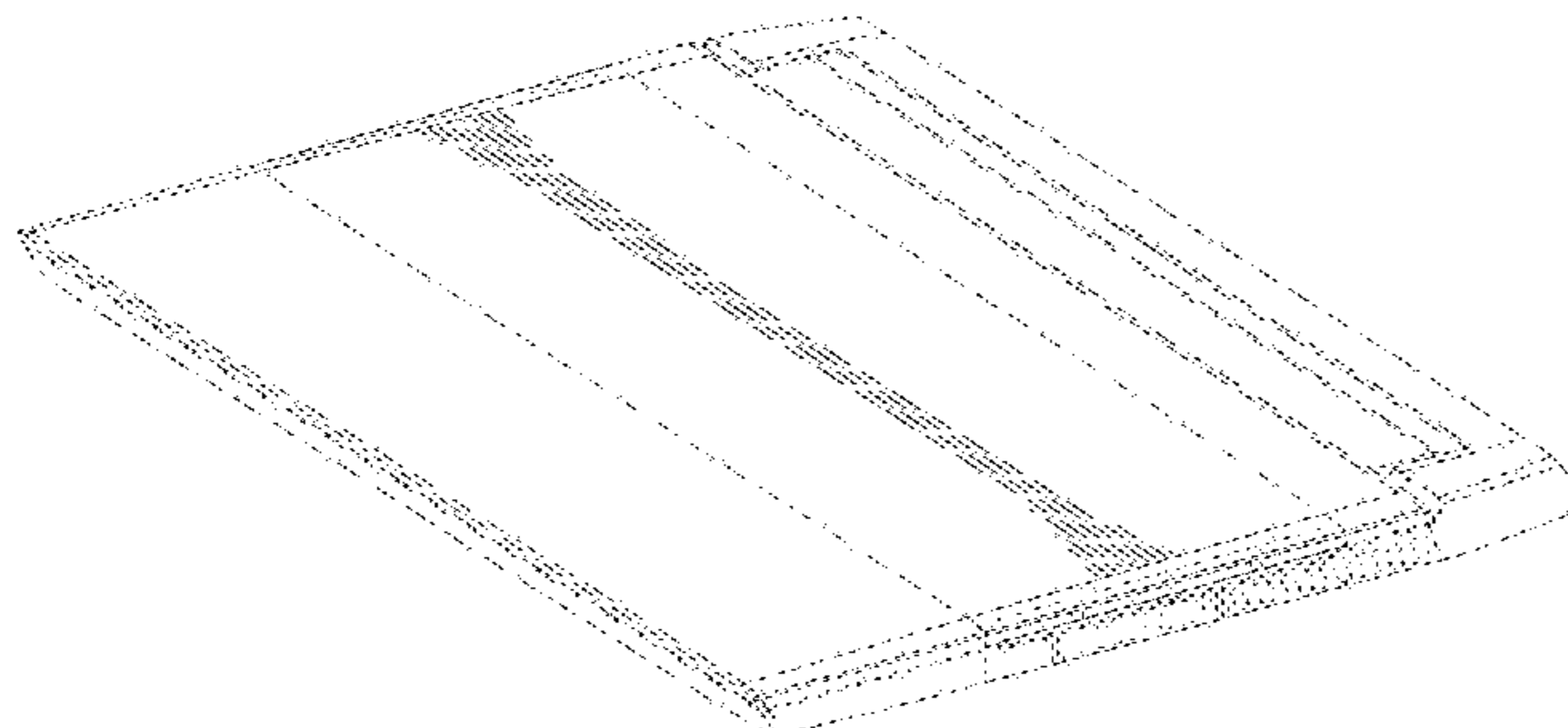

(56)

References Cited

U.S. PATENT DOCUMENTS

D749,562 S * 2/2016 Adamson D14/318
 D752,574 S * 3/2016 Lam D14/315
 D753,649 S * 4/2016 Matsuoka D14/315
 D761,248 S * 7/2016 Rivera D14/315
 D763,837 S * 8/2016 Choe D14/248
 D779,450 S * 2/2017 Kim D14/138 G
 D783,598 S * 4/2017 Bai D14/315
 D786,845 S * 5/2017 Kim D14/248
 D801,945 S * 11/2017 Cho D14/138 G
 D813,861 S * 3/2018 Goh et al.
 D829,682 S * 10/2018 Han D14/138 AB
 D832,834 S * 11/2018 Wang D14/315
 D834,009 S * 11/2018 Itou D14/248
 D835,095 S * 12/2018 Goh et al.
 D867,348 S * 11/2019 Kim D14/248
 D867,360 S * 11/2019 Kim D14/341
 D868,777 S * 12/2019 Kim D14/341
 D871,399 S * 12/2019 Kim D14/341
 D873,255 S * 1/2020 Park D14/248
 D879,080 S * 3/2020 Ishizu D14/248
 D890,163 S * 7/2020 Tzou D14/315
 D903,661 S * 12/2020 Seo D14/341

D907,613 S * 1/2021 Seo D14/248
 D910,609 S * 2/2021 Kim D14/248
 D911,335 S * 2/2021 Cheung D14/392
 D914,010 S * 3/2021 Yeh D14/318
 D914,670 S * 3/2021 Lin D14/320
 D914,671 S * 3/2021 Chung D14/320
 D918,885 S * 5/2021 Kim D14/248
 D919,615 S * 5/2021 Probst D14/324
 D920,271 S * 5/2021 Seo D14/138 G
 D922,991 S * 6/2021 Seo D14/248
 D922,992 S * 6/2021 Seo D14/248
 D924,860 S * 7/2021 Han D14/248
 D927,482 S * 8/2021 Suzuki D14/315
 D928,143 S * 8/2021 Yeom D14/315
 D928,775 S * 8/2021 Yeom D14/341
 D931,274 S * 9/2021 Hwang D14/315
 D932,476 S * 10/2021 Park D14/248
 D937,816 S * 12/2021 Park D14/248
 D938,403 S * 12/2021 Seo D14/248

FOREIGN PATENT DOCUMENTS

WO WO-D209534-002 * 8/2020
 WO WO-D210342-002 * 9/2020

* cited by examiner

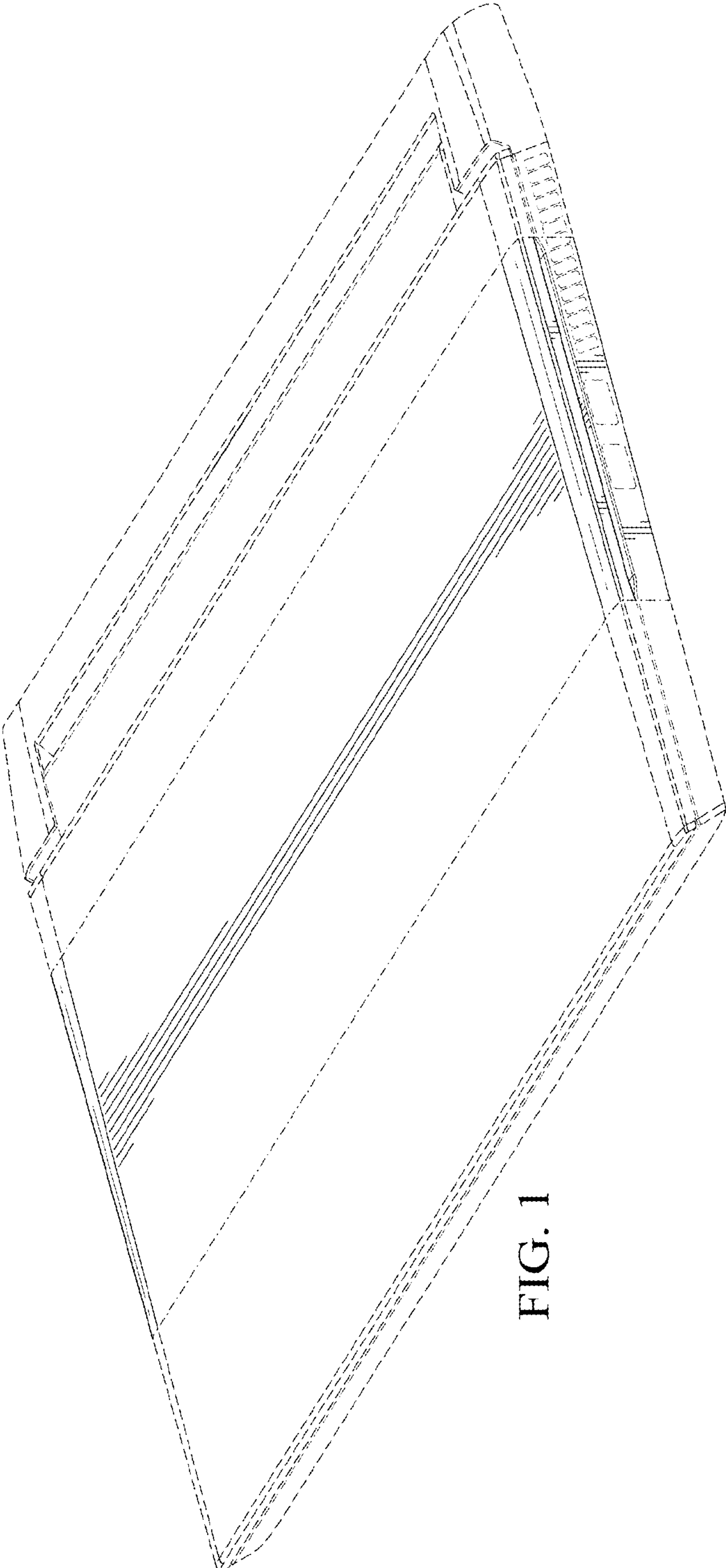

FIG. 1

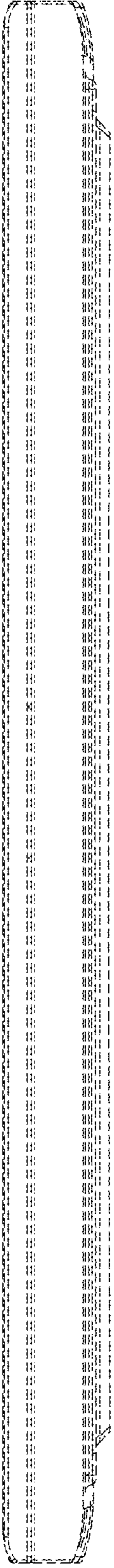

FIG. 2



FIG. 3

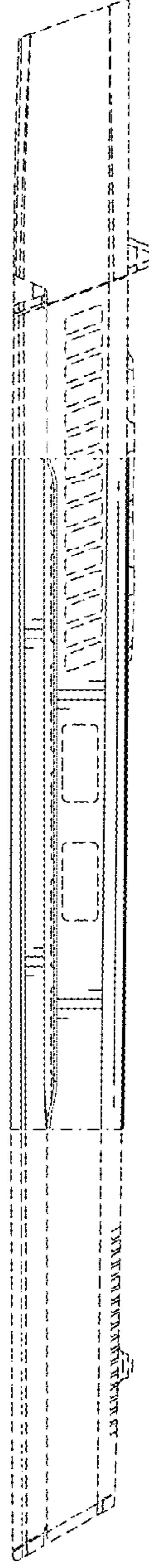

FIG. 4

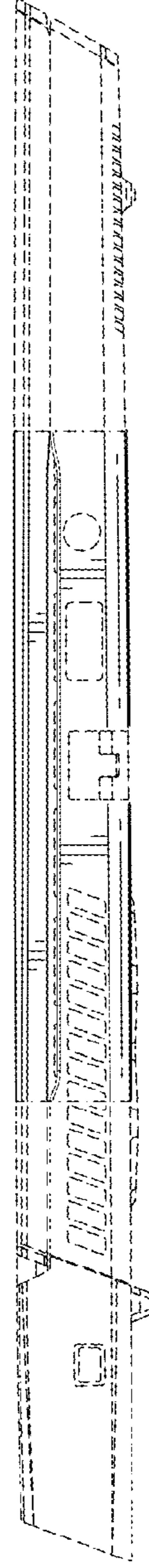

FIG. 5

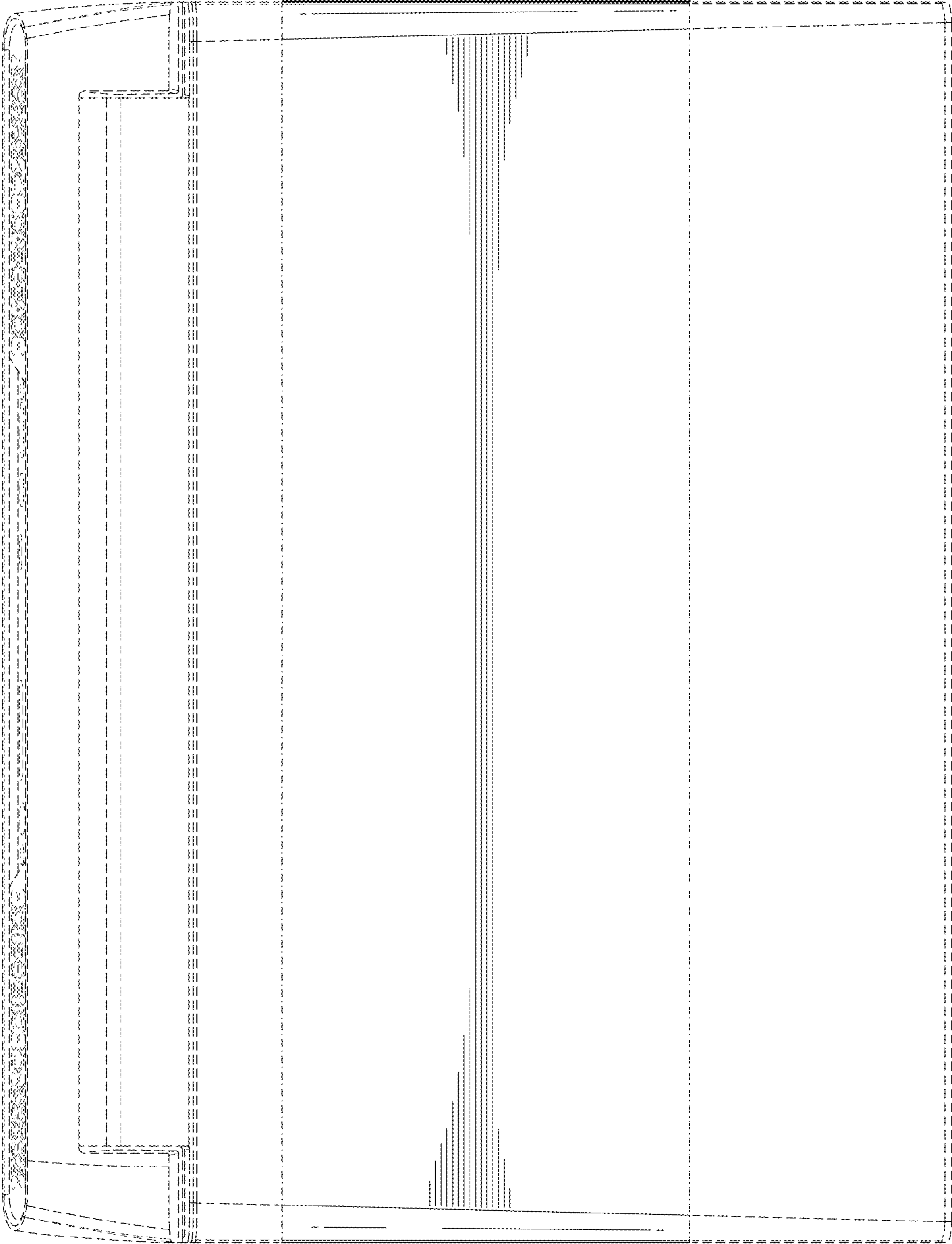
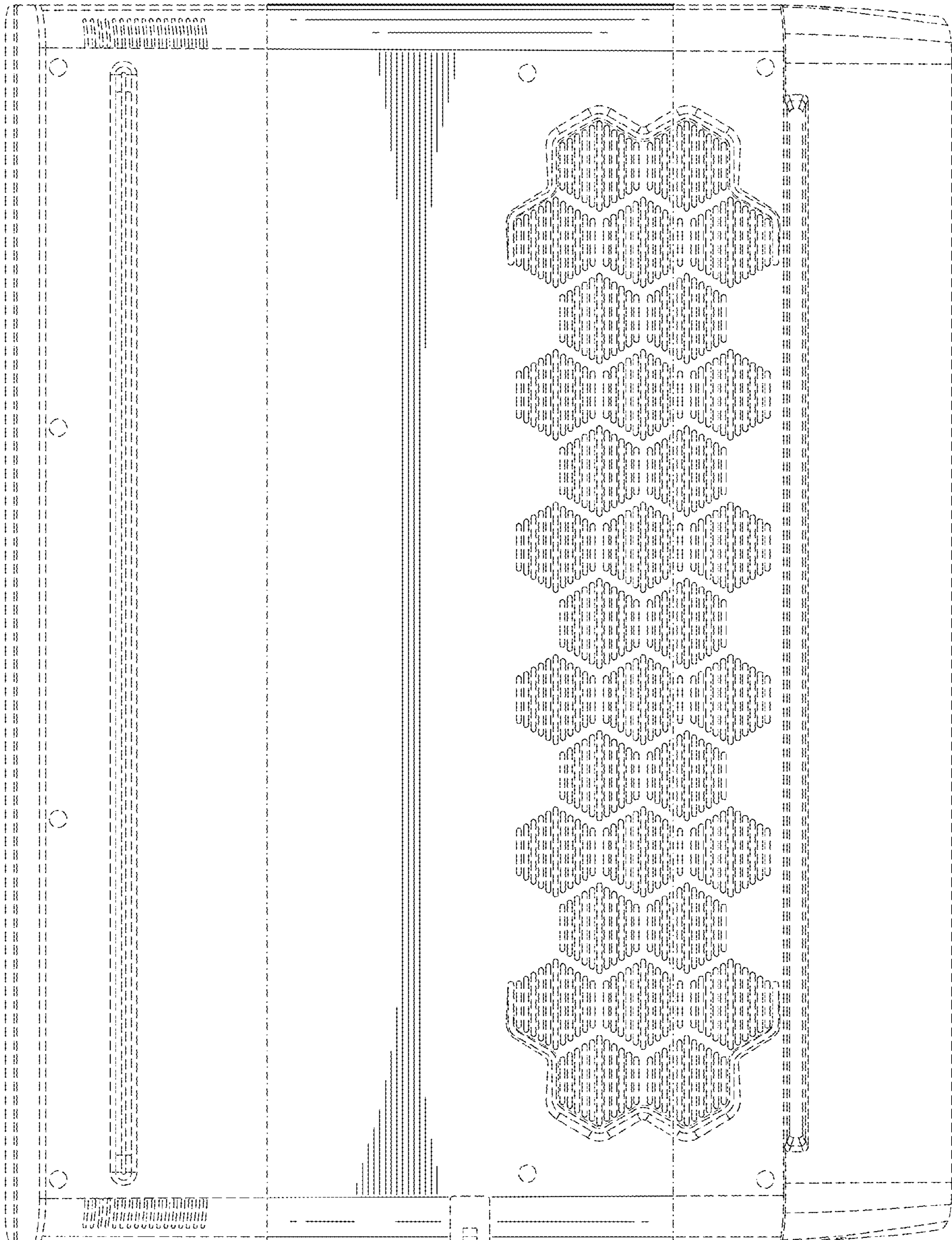

FIG. 6

FIG. 7



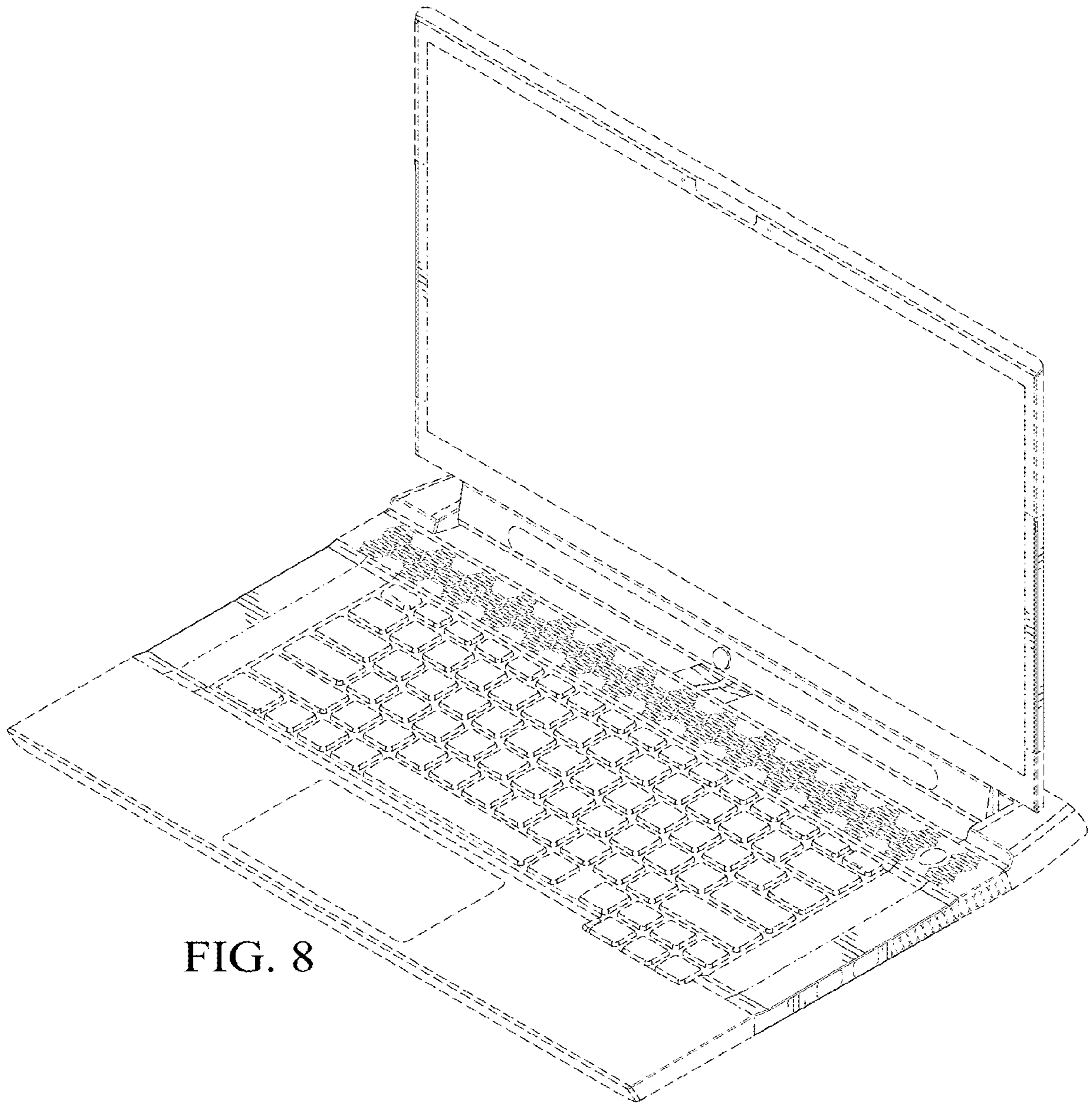

FIG. 8