



US00D953230S

(12) **United States Design Patent** (10) **Patent No.:** **US D953,230 S**
Russell et al. (45) **Date of Patent:** **** May 31, 2022**

(54) **LICENSE PLATE BRACKET**
(71) Applicant: **OMIX-ADA, INC.**, Ann Arbor, MI (US)
(72) Inventors: **Eric Lance Russell**, Lilburn, GA (US); **Amir Rahbaripour**, Alanta, GA (US)
(73) Assignee: **OMIX-ADA, INC.**, Ann Arbor, MI (US)
(**) Term: **15 Years**
(21) Appl. No.: **29/755,016**
(22) Filed: **Oct. 16, 2020**
(51) **LOC (13) Cl.** **12-16**
(52) **U.S. Cl.** **D12/193**
USPC **D12/193**
(58) **Field of Classification Search**
USPC D12/193; D6/300, 301, 302, 310-314; D26/28-38
CPC B60R 13/105; B60R 13/10; B60R 19/24; B60R 19/52
See application file for complete search history.

D826,123 S * 8/2018 Doerr D12/193
D826,815 S * 8/2018 Doerr D12/193
D839,159 S * 1/2019 Clarke D12/193
D870,623 S * 12/2019 Omelchenko D12/193
D871,988 S * 1/2020 Wang D12/193
D892,011 S 8/2020 Melrose
D896,715 S * 9/2020 Bellaflor D12/193
D911,895 S * 3/2021 Baker D12/193
(Continued)

OTHER PUBLICATIONS

EWAY Car Rear License Plate Mounting LED Bracket & Light for 2007-2017 Jeep Wrangler JK, <https://www.amazon.com.au/EWAY-License-Mounting-2007-2017-Wrangler/dp/B08311H759>, accessed on Oct. 14, 2020.

(Continued)

Primary Examiner — Kevin K Rudzinski
Assistant Examiner — Jerry Shiuian-Hua Hsu
(74) *Attorney, Agent, or Firm* — The Dobrusin Law Firm, P.C.

(57) **CLAIM**

The ornamental design for a license plate bracket, as shown and described.

DESCRIPTION

FIG. 1 is a top, front, left side perspective view of a license plate bracket, showing our new design.
FIG. 2 is a top, rear, left side perspective view thereof.
FIG. 3 is a front view thereof.
FIG. 4 is a rear view thereof.
FIG. 5 is a top view thereof.
FIG. 6 is a bottom view thereof.
FIG. 7 is a left-side view thereof; and,
FIG. 8 is a right-side view thereof.
The broken lines are used to show unclaimed portions of the license plate bracket and form no part of the claimed design.

1 Claim, 7 Drawing Sheets

(56) **References Cited**
U.S. PATENT DOCUMENTS
D263,580 S 3/1982 Scott
D294,975 S * 3/1988 Lester D12/193
D477,799 S * 7/2003 Arens D12/193
D488,754 S * 4/2004 Spencer D12/193
D517,229 S * 3/2006 Wernimont D26/31
D604,218 S * 11/2009 Lee D12/193
D610,061 S * 2/2010 Johnson D12/193
D678,828 S * 3/2013 Sanchez D12/193
D712,326 S * 9/2014 Spencer D12/193
D715,202 S * 10/2014 Spencer D12/193
D717,223 S * 11/2014 Doerr D12/193
D734,228 S * 7/2015 Masanek, Jr. D12/193
D785,526 S * 5/2017 Nathan D12/193

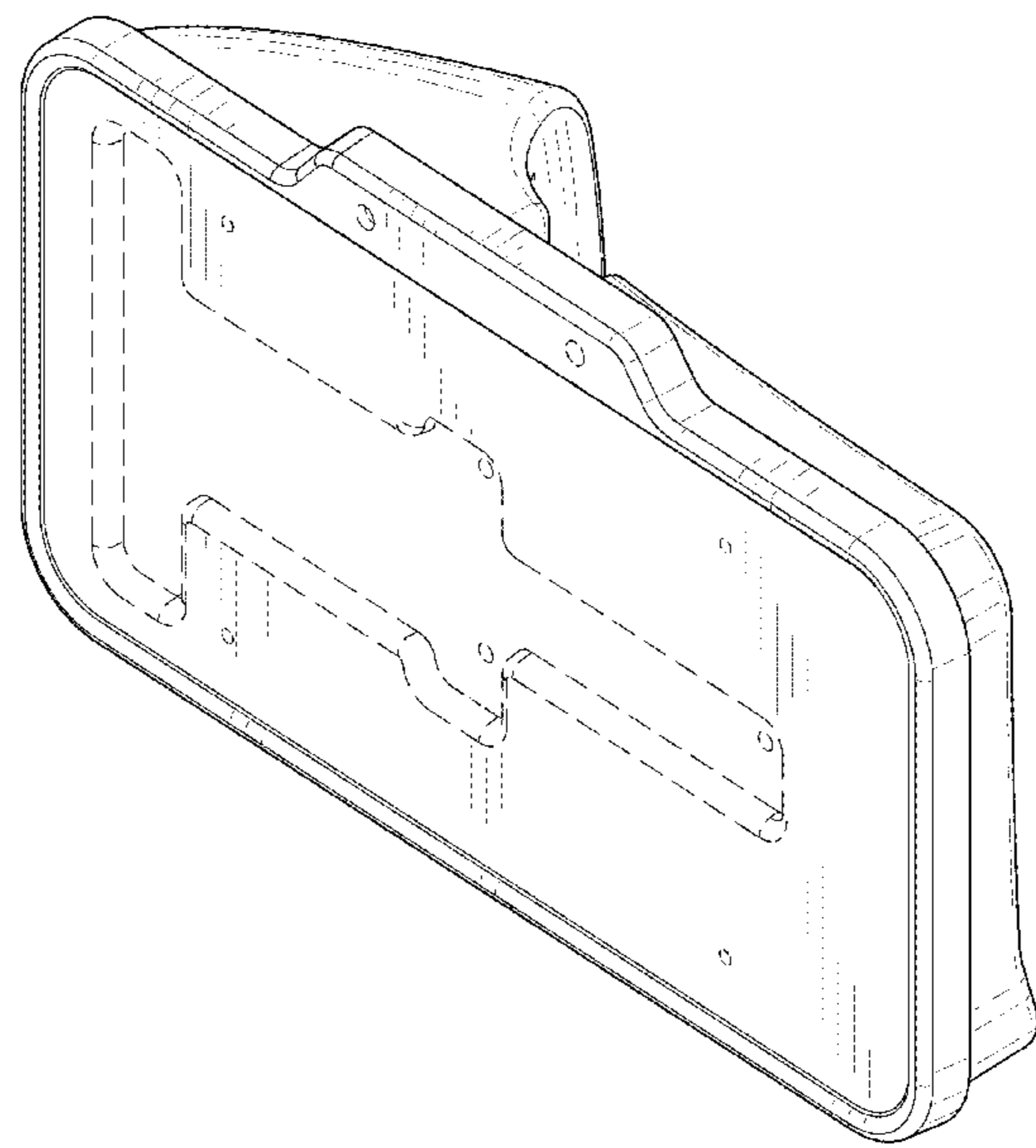

(56)

References Cited

U.S. PATENT DOCUMENTS

2006/0156595 A1* 7/2006 Kasak B60R 13/105
40/209

OTHER PUBLICATIONS

G008JP Black Rear License Plate Holder Frames Bracket with lamp for 2007-2016 Jeep Wrangler JK License Plates Mounting Bracket, https://www.amazon.com/License-Bracket-2007-2016-Wrangler-Mounting/dp/B07FXK743R/ref=sr_1_37?dchild=1&keywords=jeep+license+plate+relocation+kit&qid=160282884&sr=8-37. accessed on Oct. 14, 2020.

A ABIGAIL Black Rear License Plate Holder Frames Plastic Bracket with LED Light Fits for 2007-2016 Jeep Wrangler JK License Plates Mounting Bracket, https://www.amazon.com/ABIGAIL-License-2007-2016-Wrangler-Mounting/dp/B07X5W6Q4X/ref=sr_1_59?dchild=1&keywords=jeep+license+plate+relocation_+kit&qid=1602682884&sr=8-59.

Fab Fours M4550-1 Rear Bumper License Plate Mount for 18-21 Jeep Wrangler JL, <https://www.quadratec.com/p/fab-fours/rear-bumper-license-plate-mount-jeep-wrangler-jl>, accessed Oct. 14, 2020.
Rugged Ridge 11238.15 License Plate Holder, <https://www.quadratec.com/p/rugged-ridge/license-plate-holder-11238.15>, accessed Oct. 14, 2020.

* cited by examiner

Fig. 1

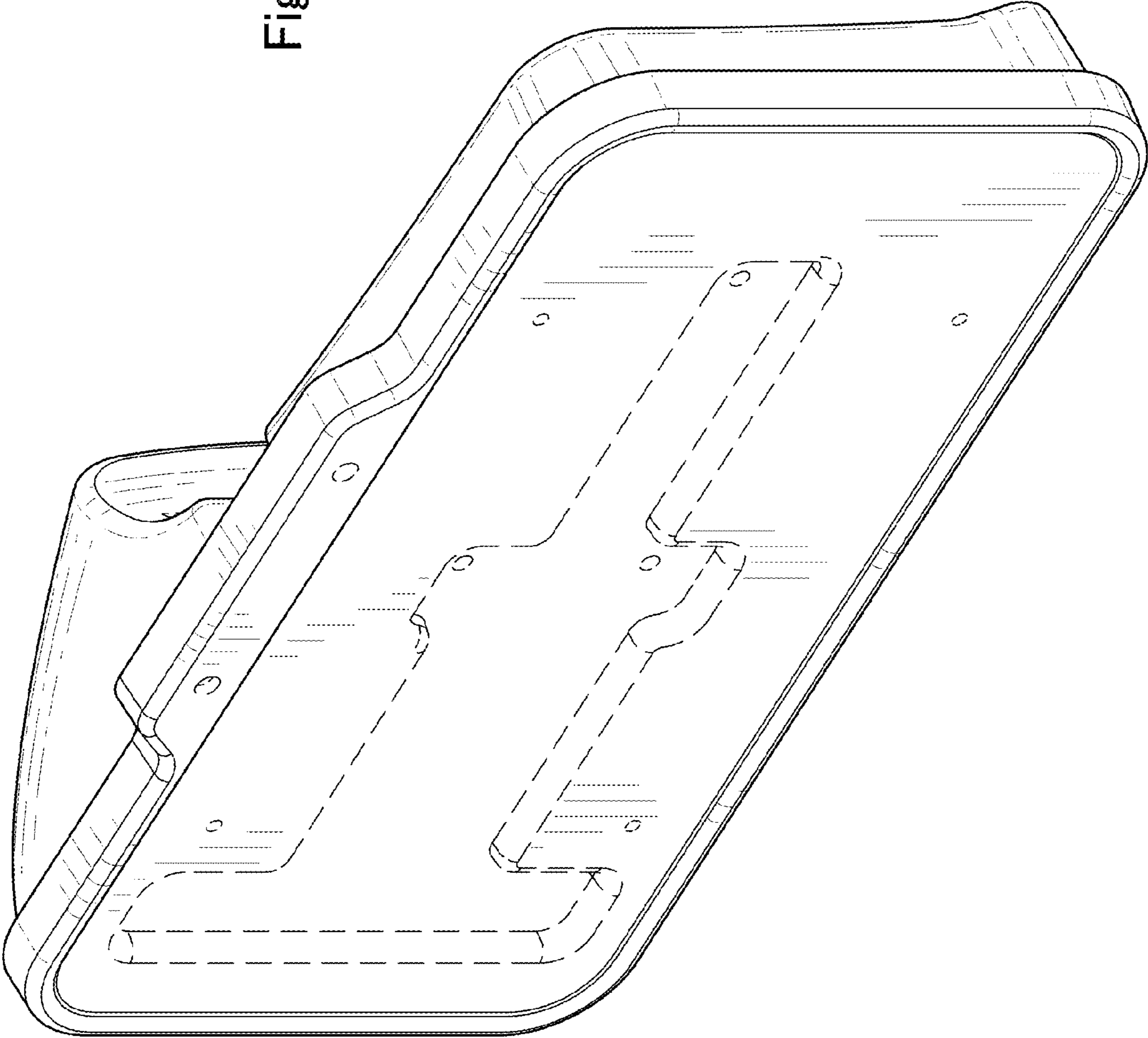

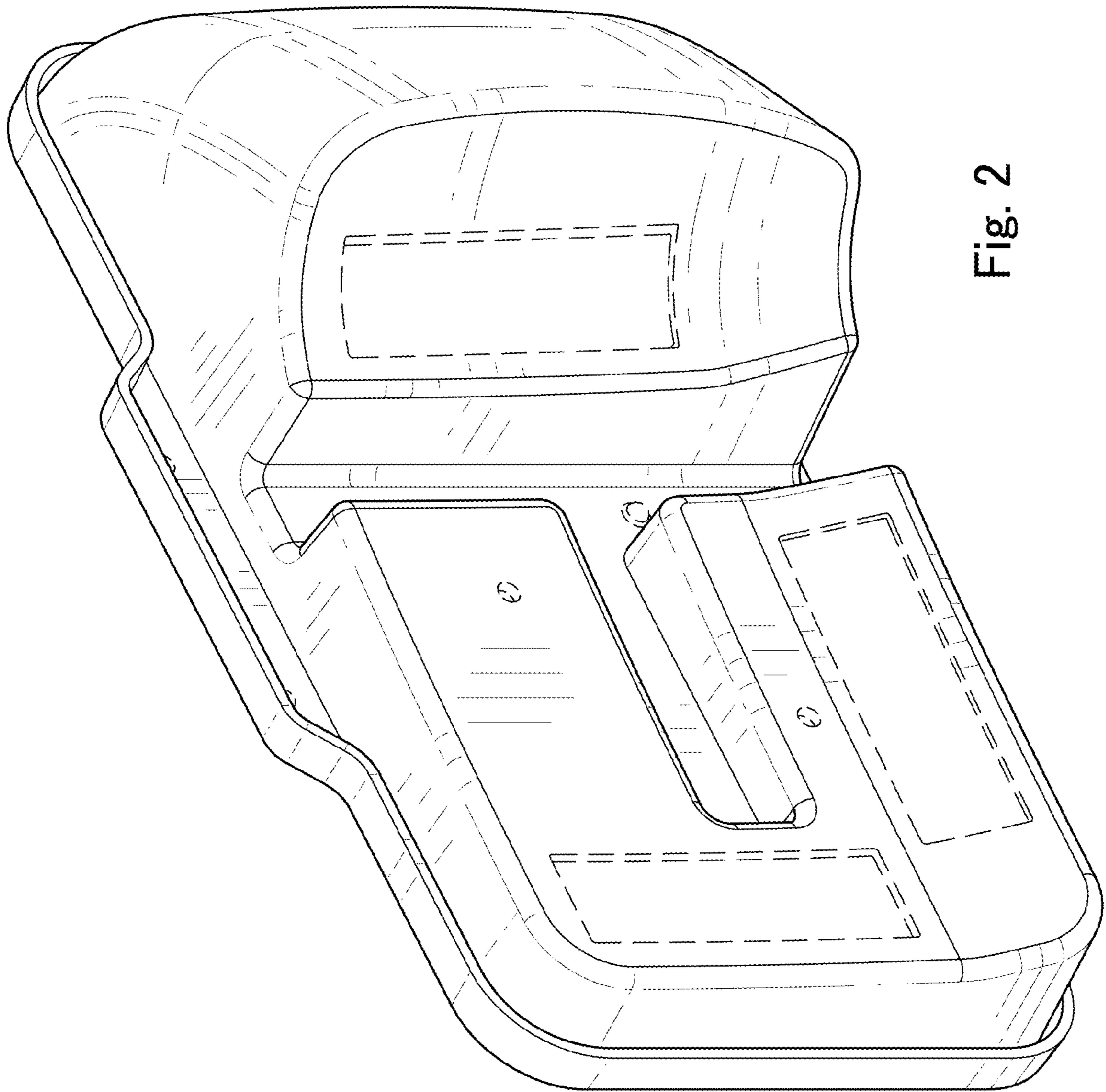

Fig. 2

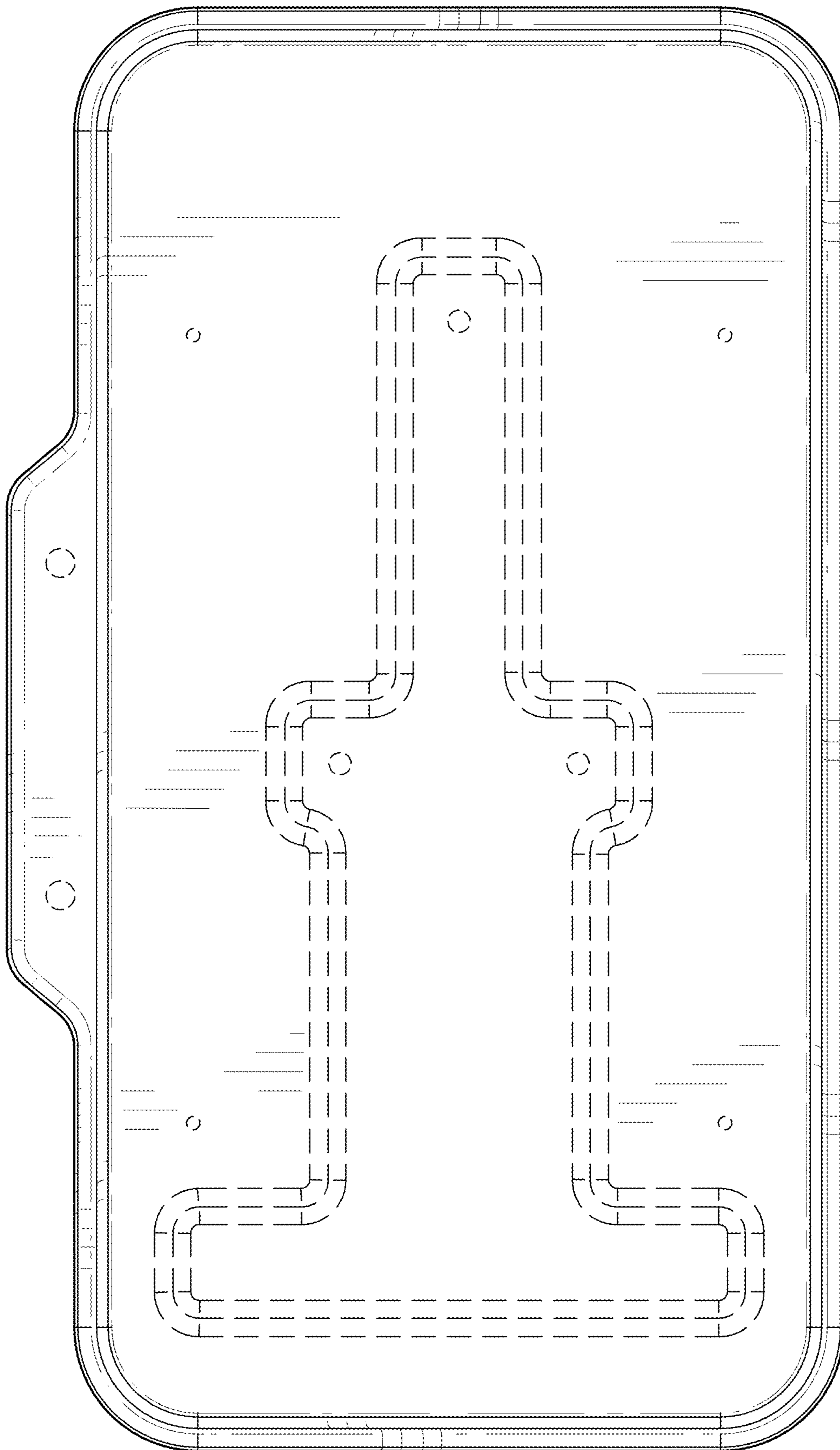

Fig. 3

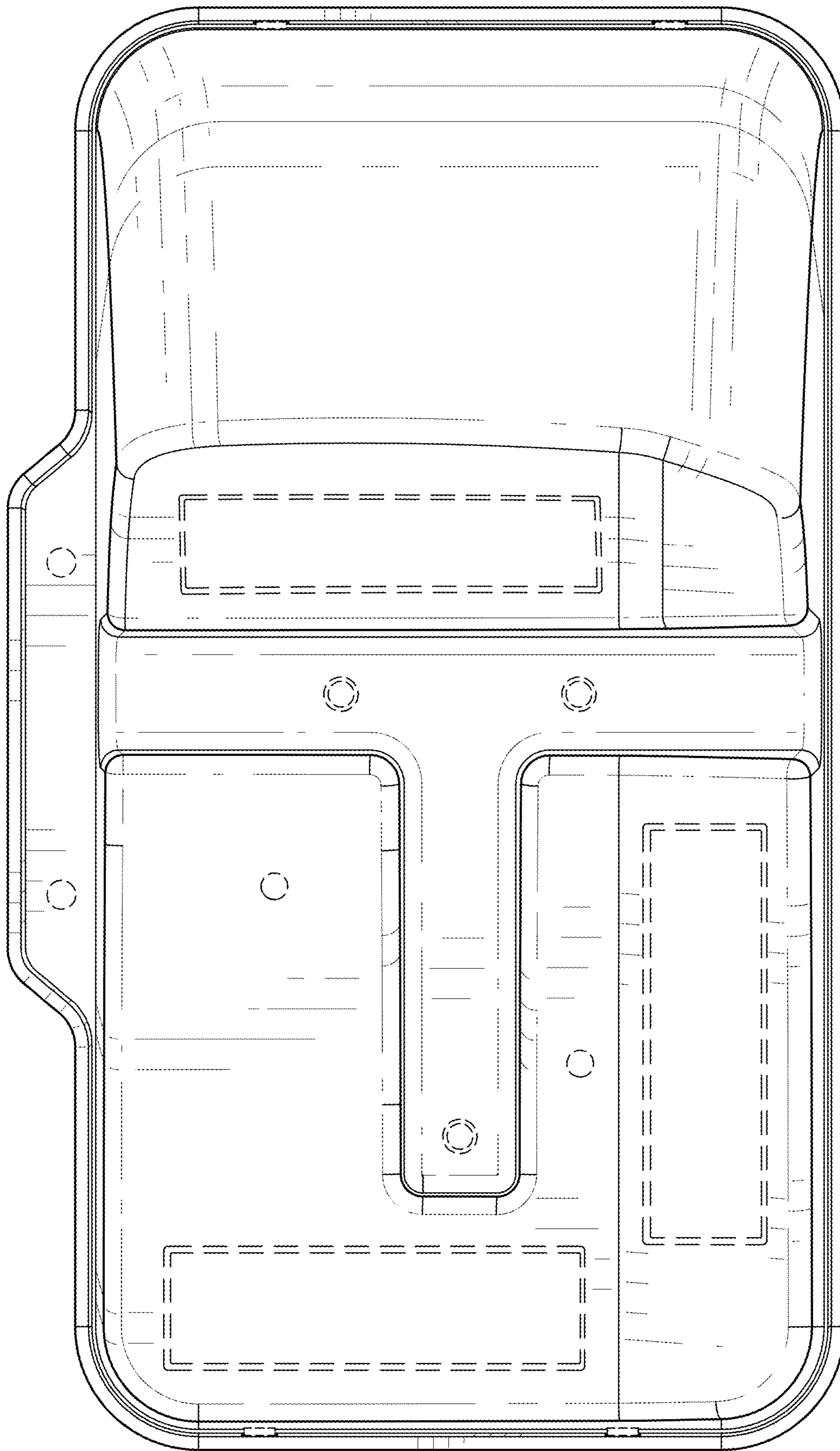

Fig. 4

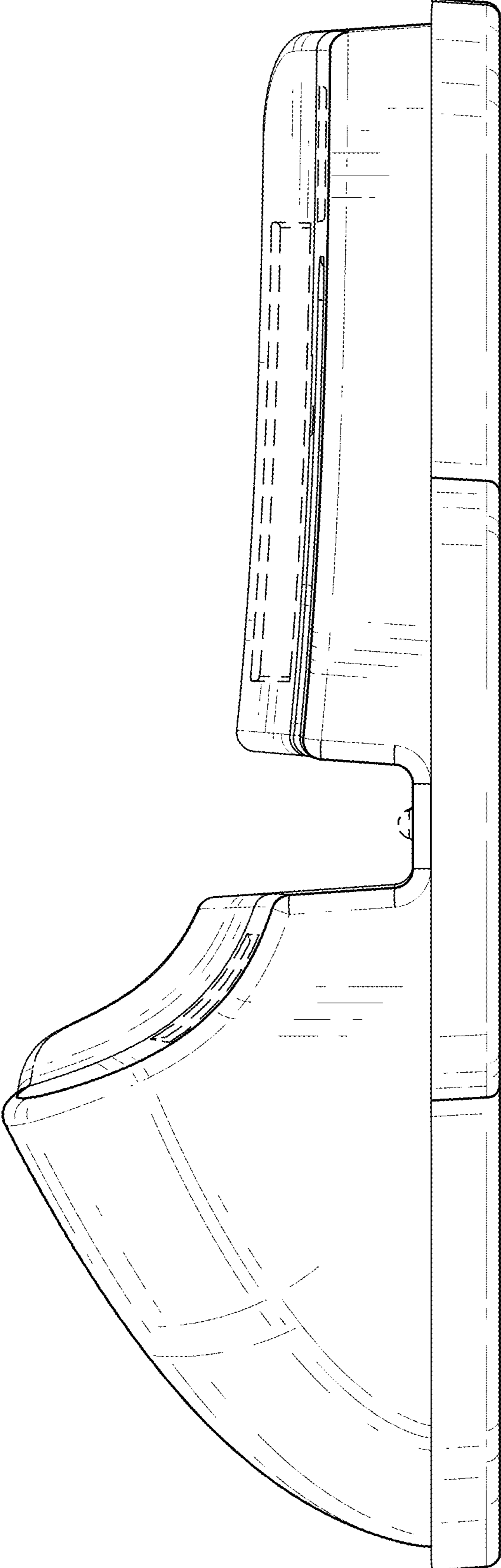

Fig. 5

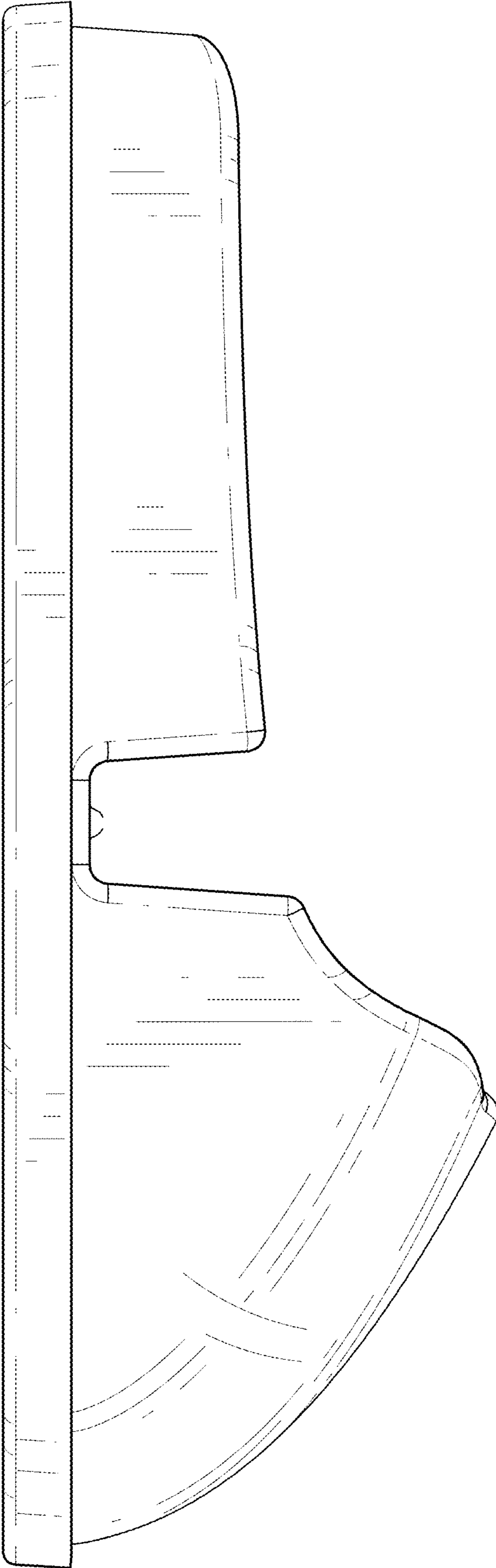

Fig. 6

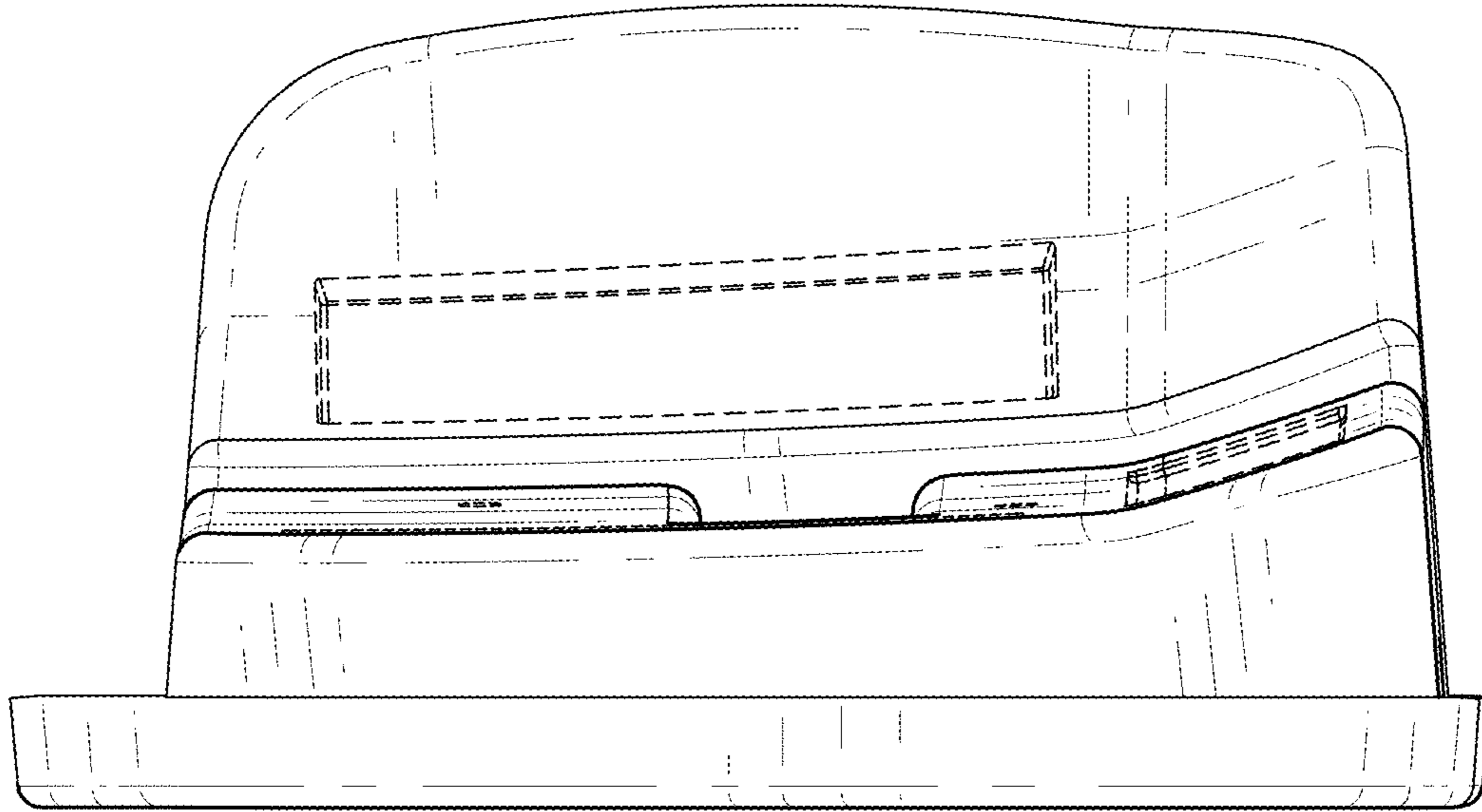

Fig. 8

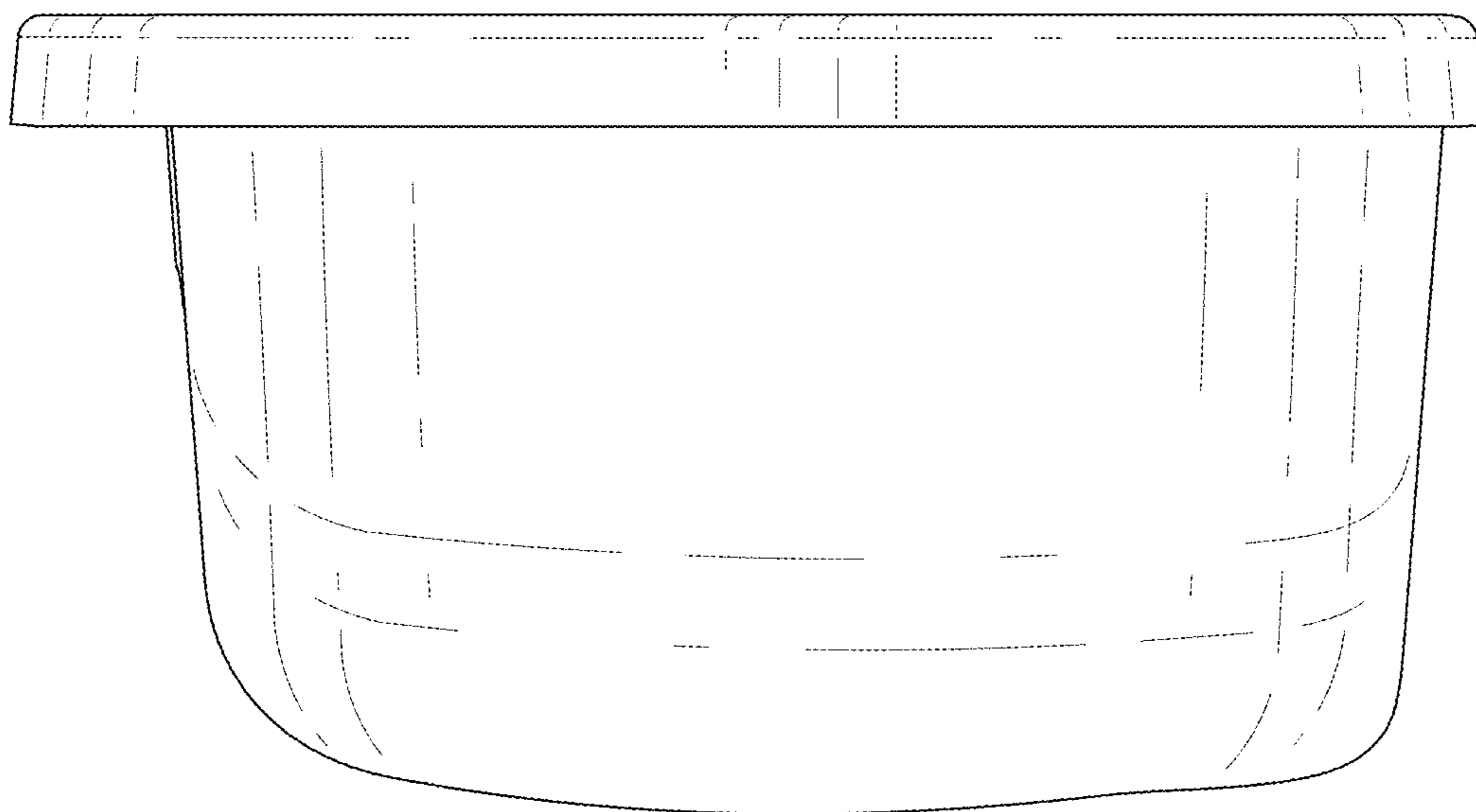

Fig. 7