



US00D953187S

(12) **United States Design Patent** (10) **Patent No.:** **US D953,187 S**
Sivriere (45) **Date of Patent:** **** May 31, 2022**

(54) **ARTICLE OF JEWELRY**
(71) Applicant: **RICHEMONT INTERNATIONAL SA, Villars-sur-Glane (CH)**
(72) Inventor: **Stéphanie Sivriere, Geneva (CH)**
(73) Assignee: **RICHEMONT INTERNATIONAL SA, Villars-sur-Glane (CH)**
(**) Term: **15 Years**

D292,682 S * 11/1987 Bulgari D11/27
D363,146 S * 10/1995 Pando D29/113
D372,879 S * 8/1996 Partridge D11/4
D428,353 S * 7/2000 Duncan D11/5
D483,912 S * 12/2003 Prince D28/64.2
D523,769 S * 6/2006 Arlanda D11/26
(Continued)

(21) Appl. No.: **29/734,240**
(22) Filed: **May 11, 2020**
(30) **Foreign Application Priority Data**

FOREIGN PATENT DOCUMENTS

WO D200730-001 * 6/2019
WO D212229-001 * 1/2021

Mar. 18, 2020 (WO) WIPO93206

OTHER PUBLICATIONS

Piaget: Journey of the Sun, available Jun. 22, 2021, online, site visited Mar. 22, 2022. Available online, URL: <https://curatedition.com/watches-and-jewellery/piaget-sunlight-collection-journey-of-the-sun/> (Year: 2021).*
(Continued)

(51) **LOC (13) Cl.** **11-01**
(52) **U.S. Cl.**
USPC **D11/34**
(58) **Field of Classification Search**
USPC D11/1-5, 15-17, 20, 26-29, 34
CPC A44C 5/0084; A44C 5/0092; A44C 5/12;
A44C 17/02
See application file for complete search history.

Primary Examiner — W. A. Teddy Falloway
Assistant Examiner — Sarah J Ault
(74) *Attorney, Agent, or Firm* — Oliff PLC

(57) **CLAIM**

The ornamental design for an article of jewelry, as shown and described.

(56) **References Cited**

DESCRIPTION

U.S. PATENT DOCUMENTS

902,606 A * 11/1908 Robbins A44C 9/00
63/15
D148,351 S * 1/1948 Hamilton D11/4
D151,361 S * 10/1948 Katz D11/4
2,599,311 A * 6/1952 Anderson G09F 3/005
206/37
2,756,572 A * 7/1956 Yeager A44C 17/04
29/523
D199,195 S * 9/1964 Michelotti D11/30
3,586,220 A * 6/1971 Reinsberg A44C 5/0015
24/584.1
D248,598 S * 7/1978 Bahmer D11/27
D285,821 S * 9/1986 Kneisley D11/5

FIG. 1 is a front, left-side, top perspective view of the article of jewelry, showing the new design;
FIG. 2 is a front elevational view thereof;
FIG. 3 is a rear-elevational view thereof;
FIG. 4 is a left-side elevational view thereof;
FIG. 5 is a right-side elevational view thereof;
FIG. 6 is a top plan view thereof; and,
FIG. 7 is a bottom plan view thereof.
The broken lines depict parts of the article of jewelry that from no part of the claimed design.

1 Claim, 7 Drawing Sheets

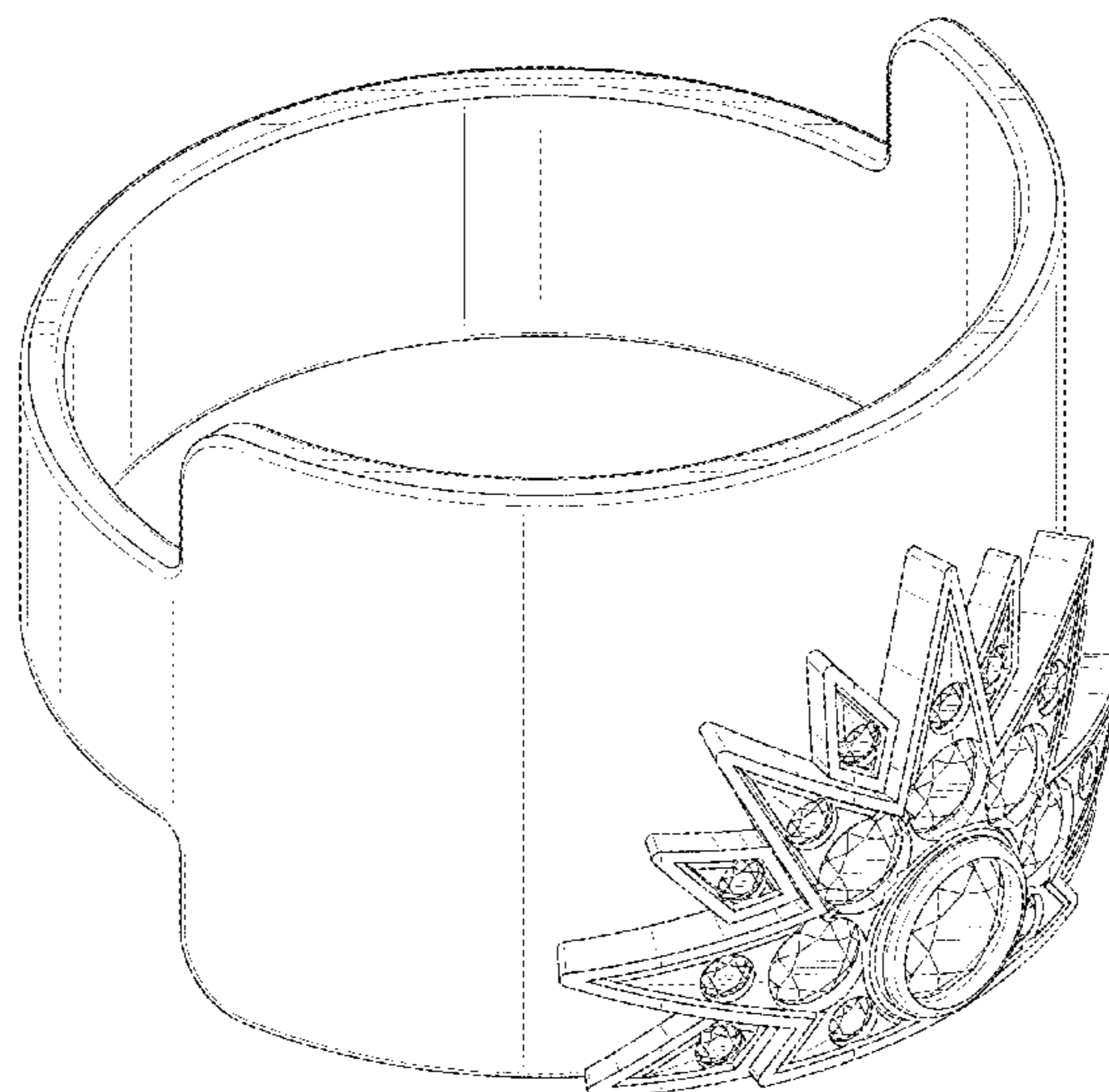

(56)

References Cited

U.S. PATENT DOCUMENTS

D523,770	S	*	6/2006	Arlanda	D11/26
D651,933	S	*	1/2012	Bullock	D11/26
D664,467	S	*	7/2012	Marconi	D11/34
D701,135	S	*	3/2014	Penner	D11/27
D704,088	S	*	5/2014	Farris	D11/26
D725,068	S	*	3/2015	Cho	D14/344
D753,011	S	*	4/2016	Crane	D11/26
D780,027	S	*	2/2017	Stern	D11/34
D813,075	S	*	3/2018	Zagami	D11/4
D821,910	S	*	7/2018	Stern	D11/34
D822,527	S	*	7/2018	Stern	D11/4
D826,078	S	*	8/2018	Stern	D11/26
D848,302	S	*	5/2019	Buccellati	D11/16
D848,895	S	*	5/2019	Buccellati	D11/16
D852,079	S	*	6/2019	Sivriere	D11/79
D865,561	S	*	11/2019	Sivriere	D11/42
D869,775	S	*	12/2019	Voosen	D29/114
D871,954	S	*	1/2020	Foster	D11/4
D896,681	S	*	9/2020	Sivriere	D11/34
D906,862	S	*	1/2021	Sivriere	D11/41
D909,233	S	*	2/2021	Sivriere	D11/79
D909,234	S	*	2/2021	Sivriere	D11/79
D914,534	S	*	3/2021	Sivriere	D11/43

OTHER PUBLICATIONS

Piaget Sunlight Ring, available Mar. 14, 2022, online, site visited Mar. 14, 2022. Available online, URL: <https://www.piaget.com/jewelry/piaget-sunlight/rose-gold-diamond-ring-g34r0600> (Year: 2022).*

* cited by examiner

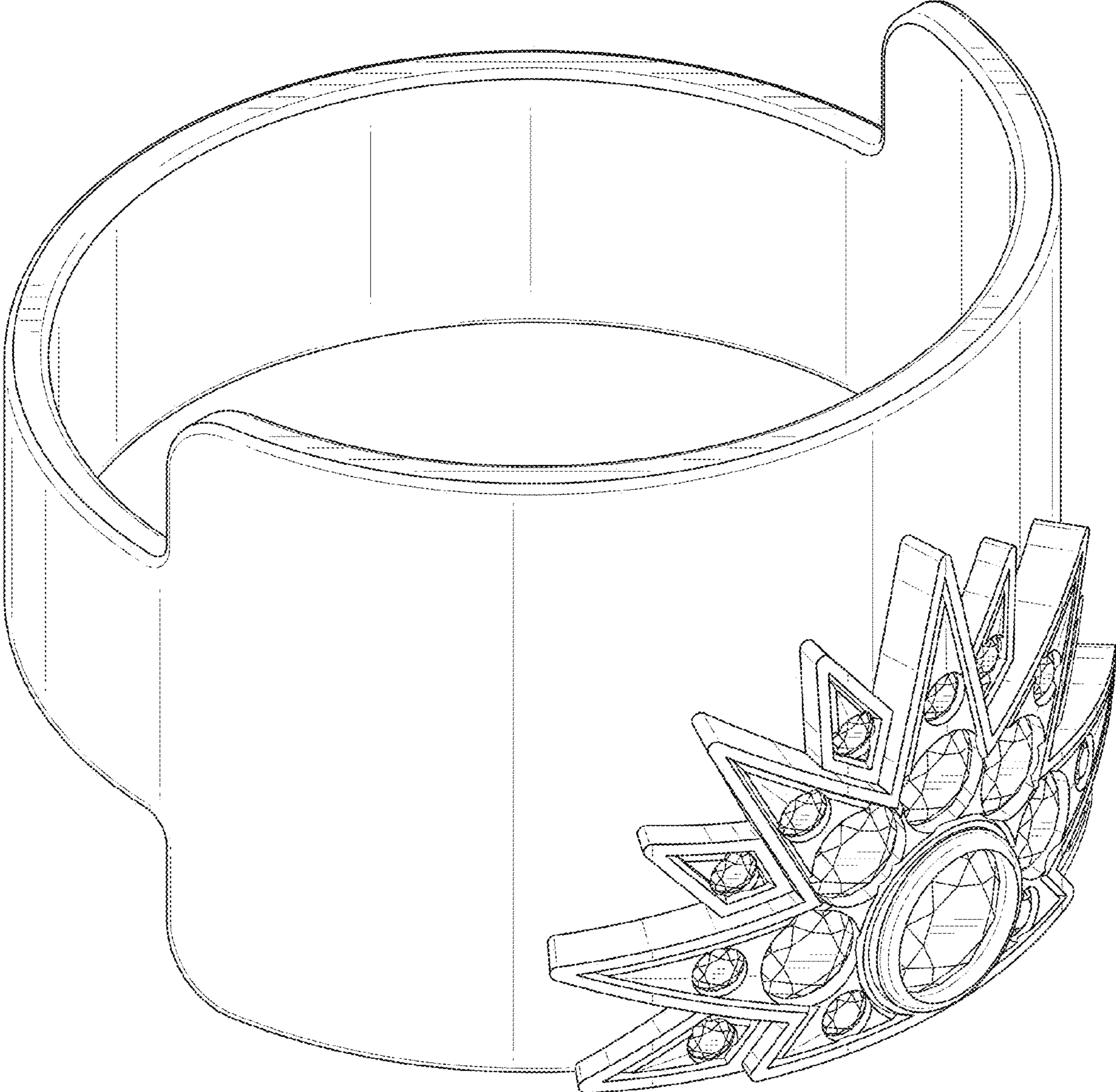

FIG. 1

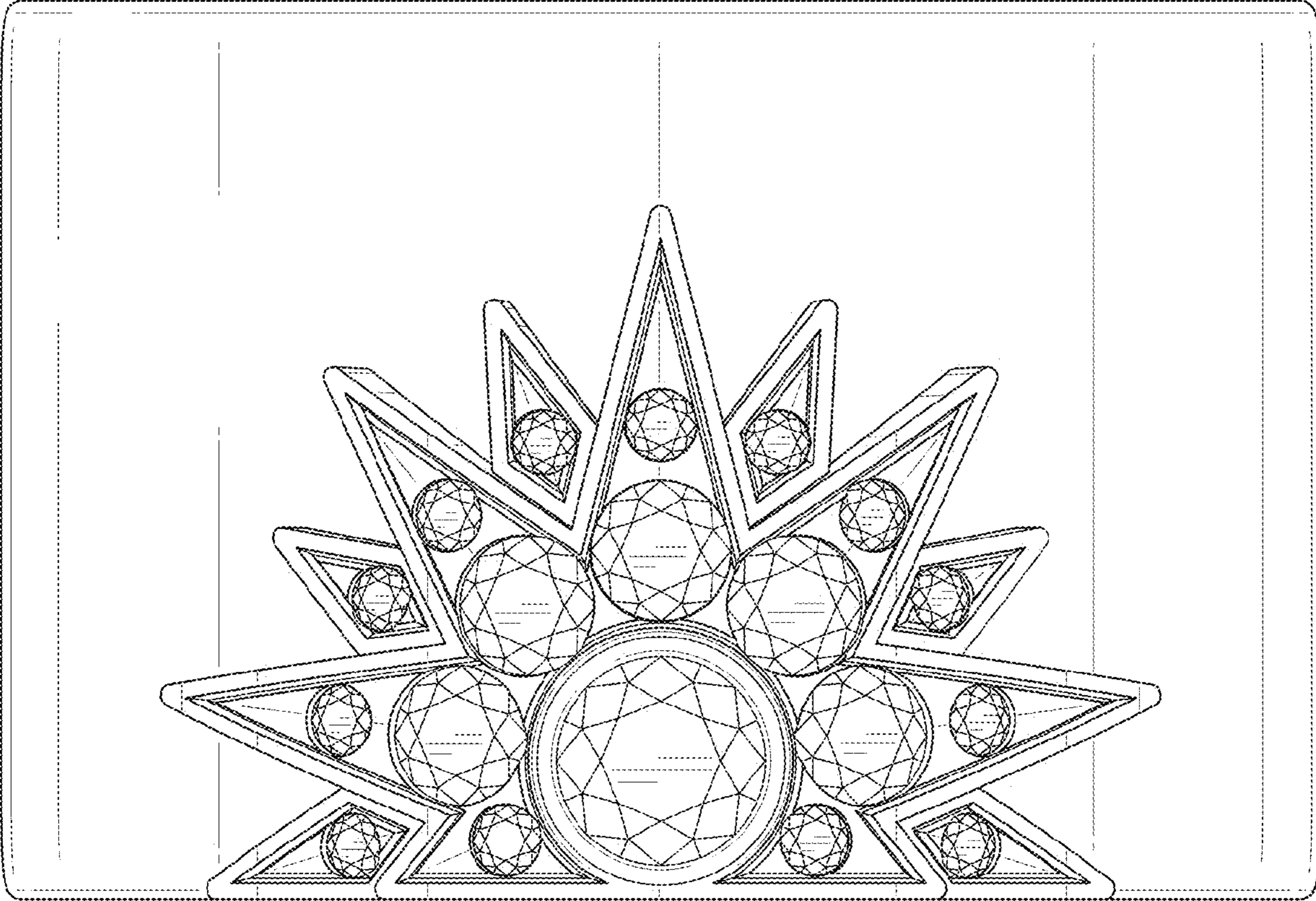

FIG. 2

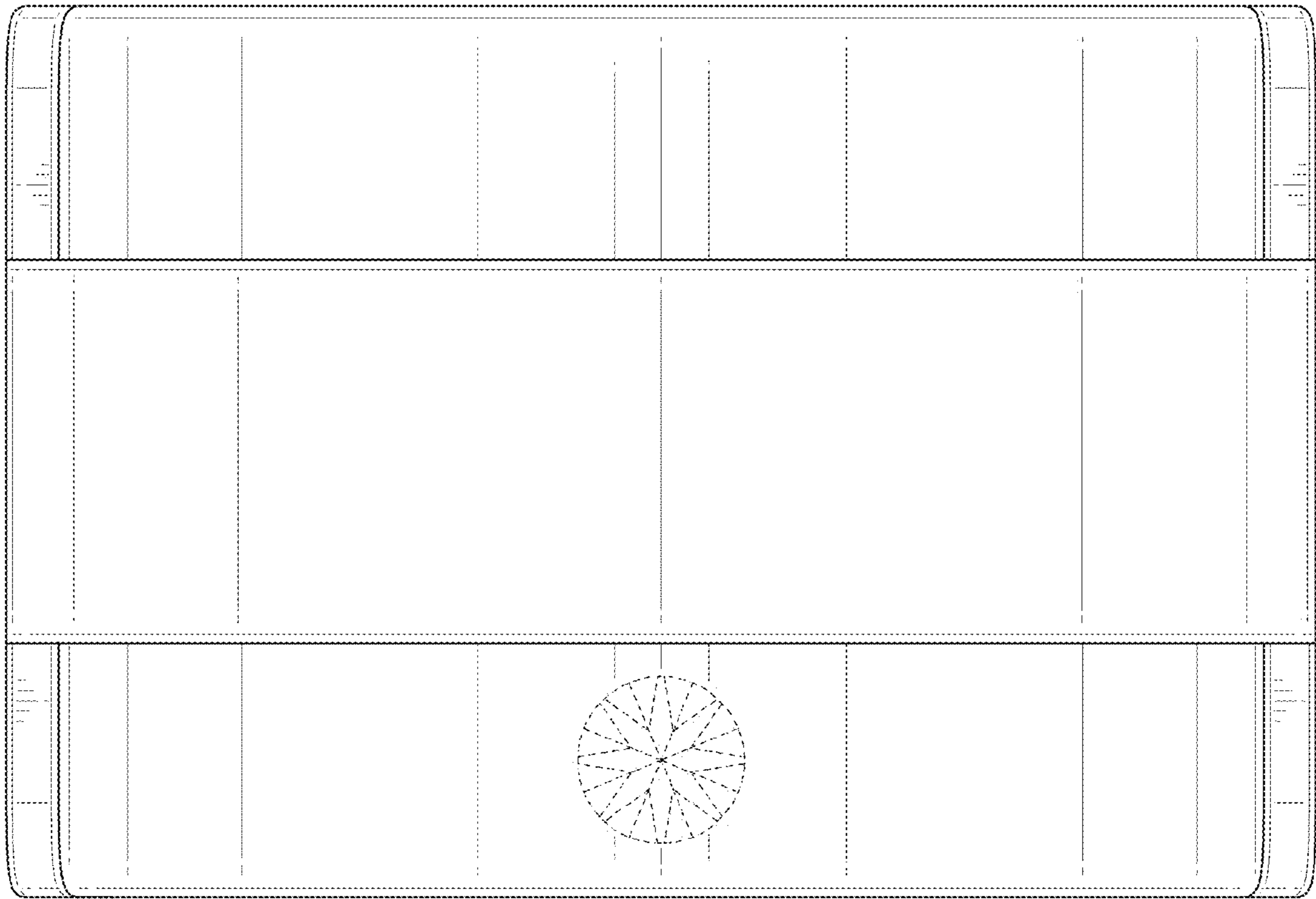

FIG. 3

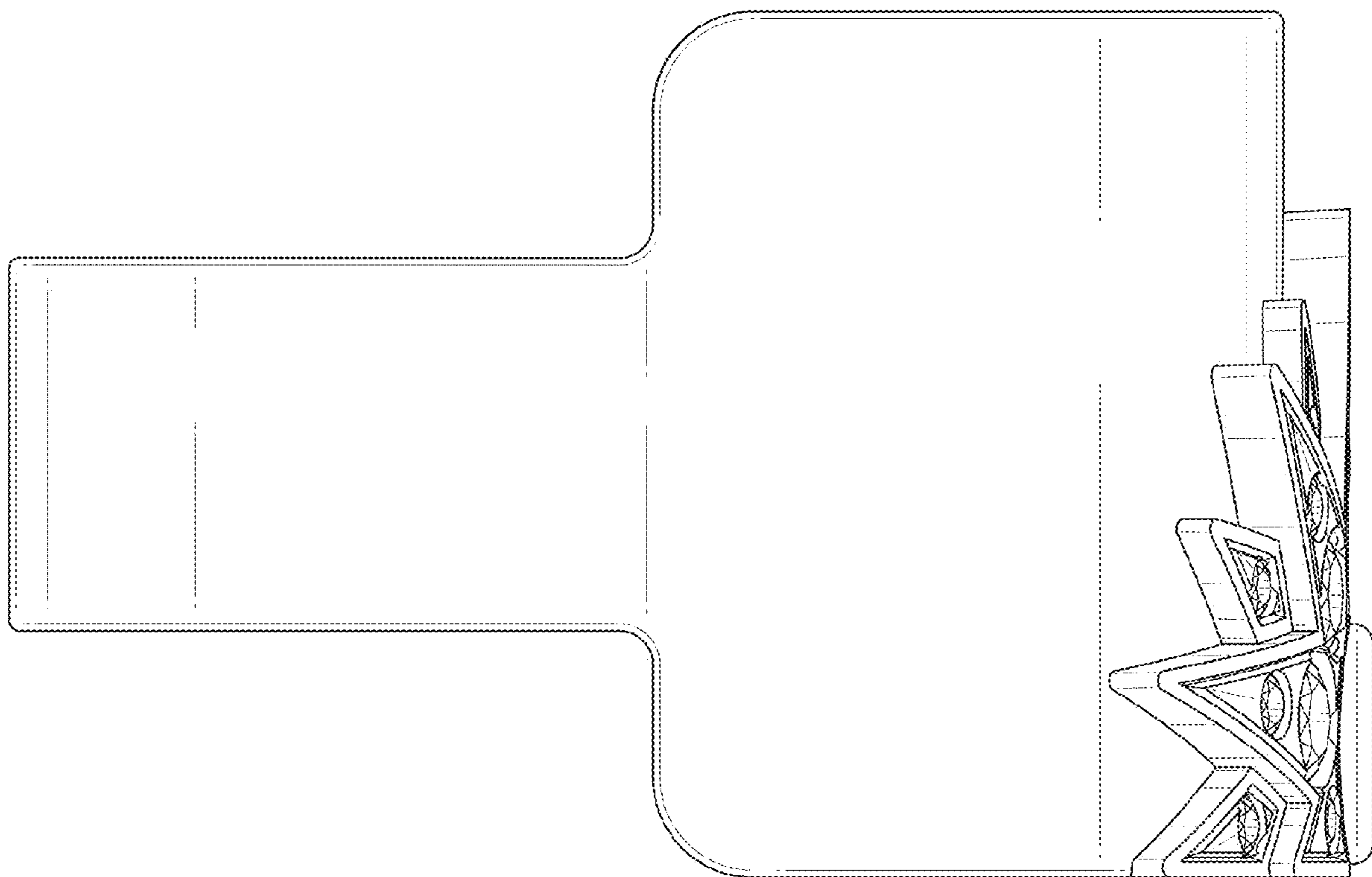

FIG. 4

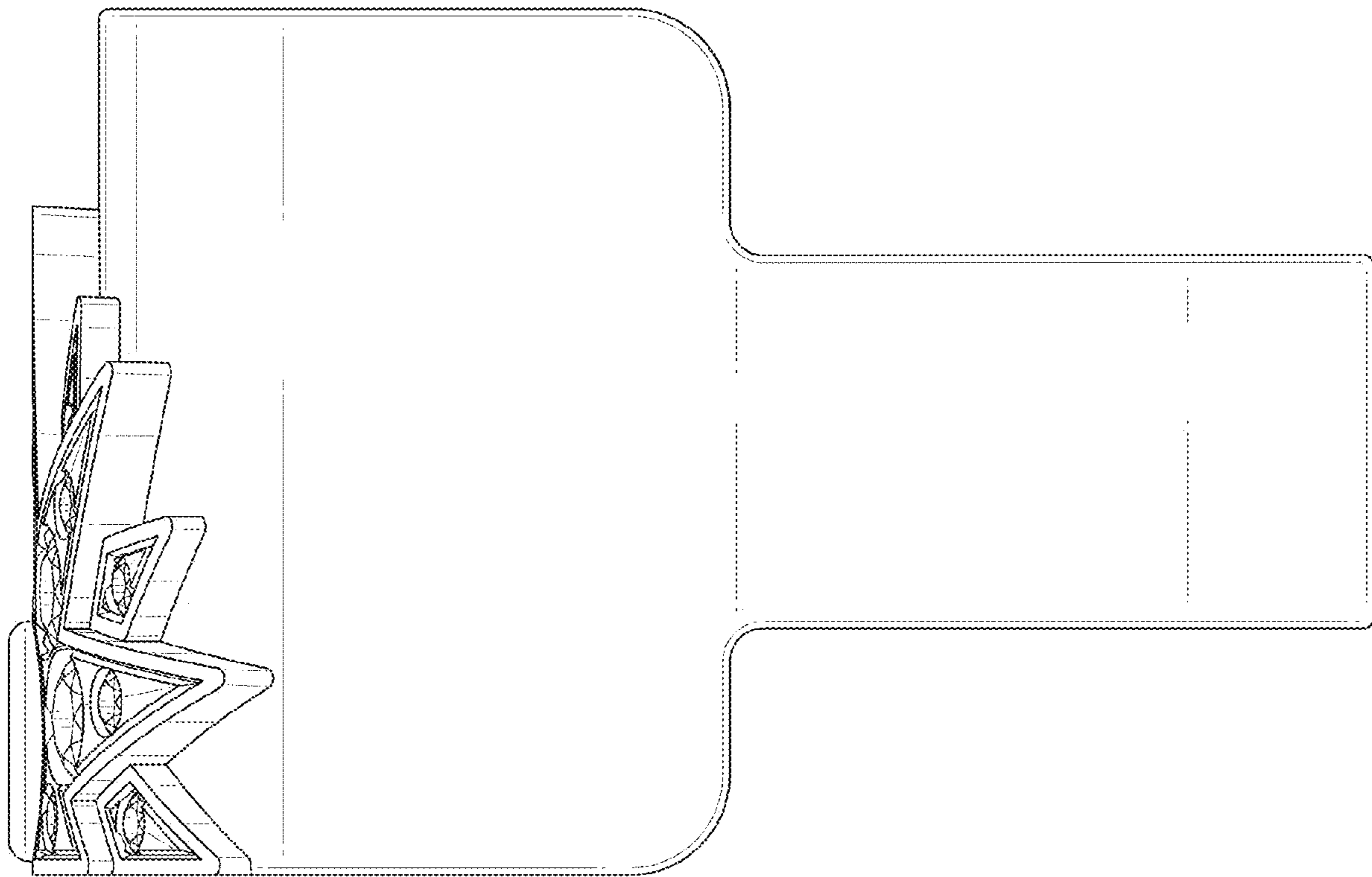

FIG. 5

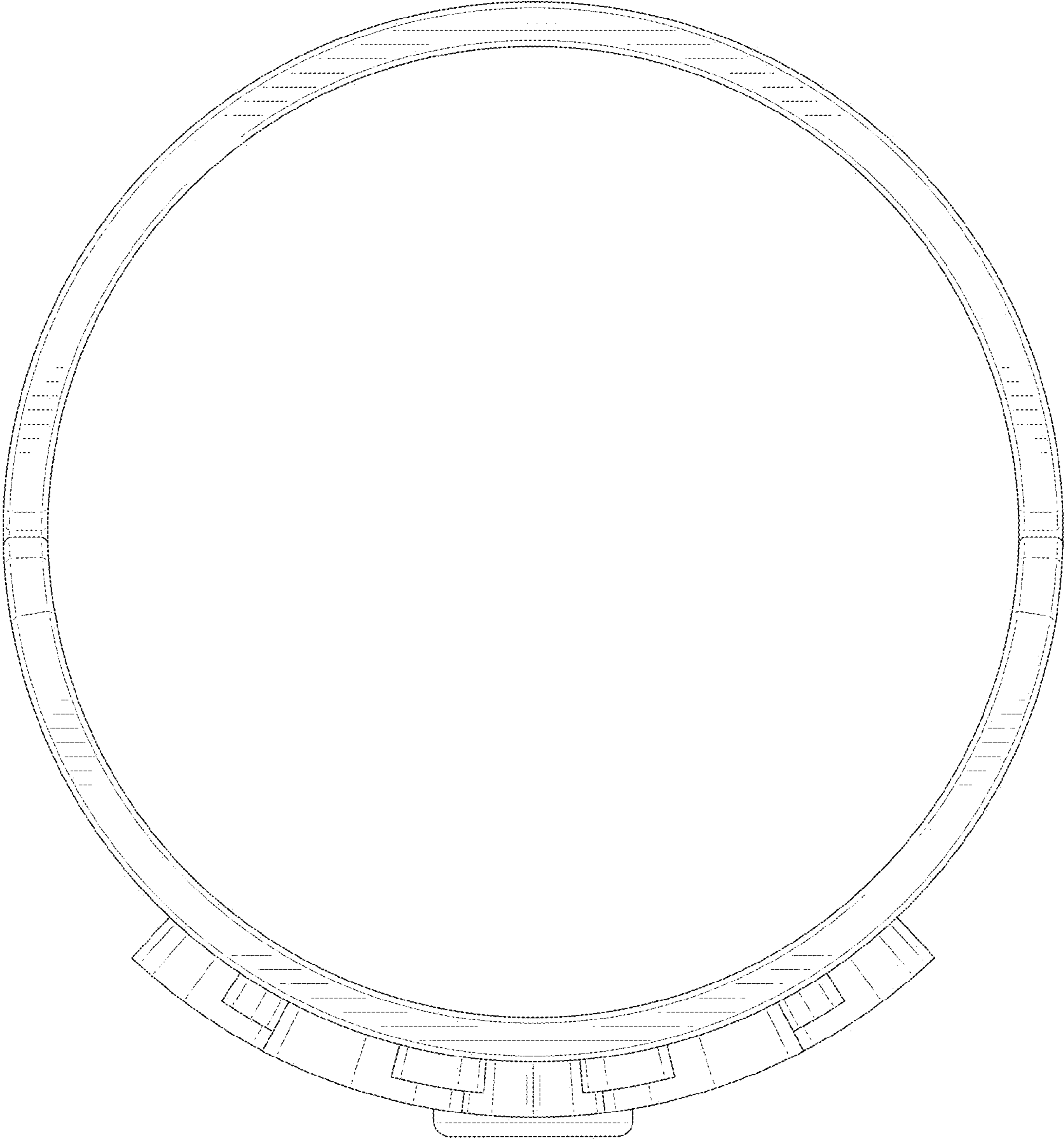

FIG. 6

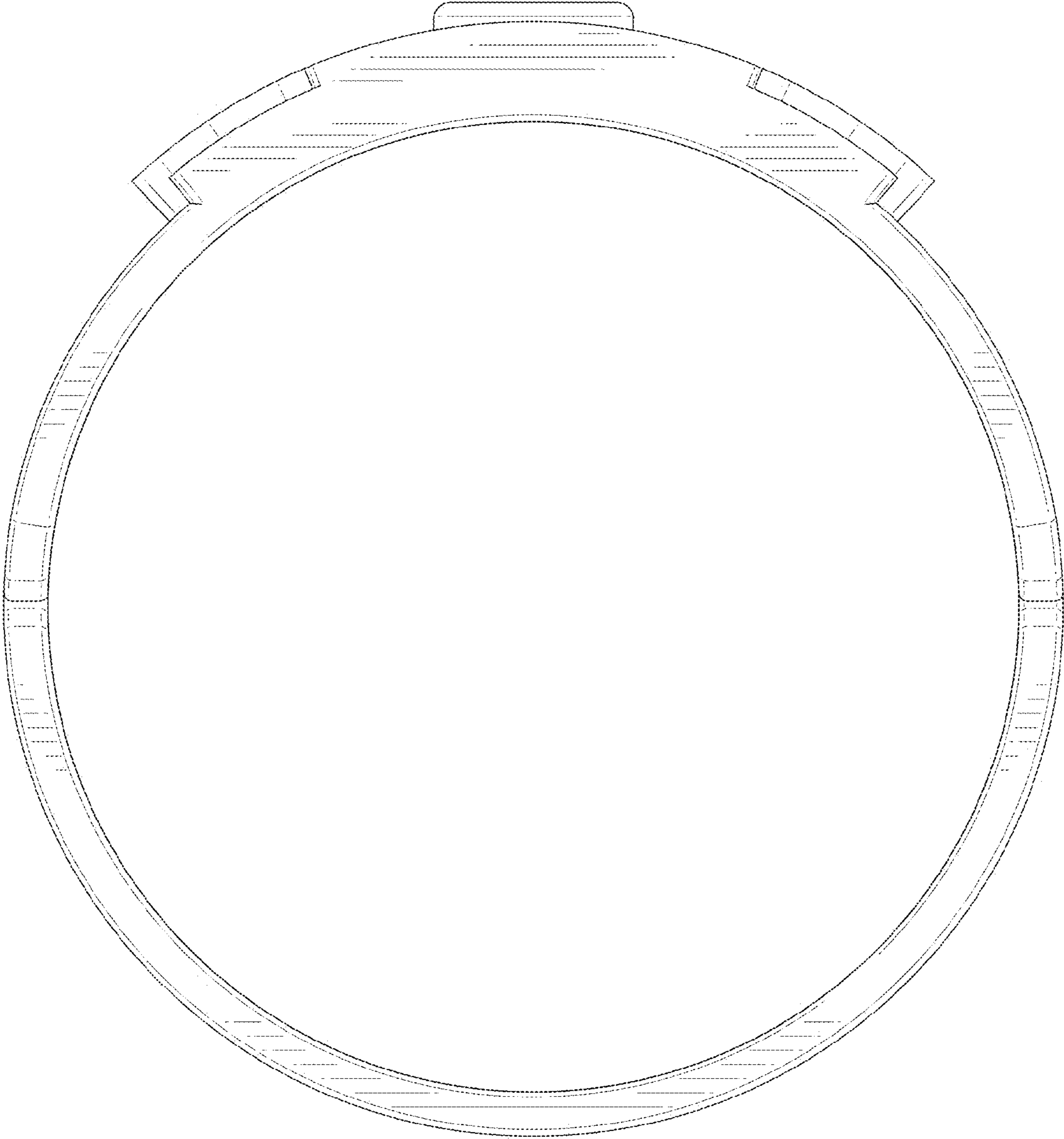

FIG. 7