



US00D953183S

(12) **United States Design Patent** (10) **Patent No.:** **US D953,183 S**
Dong et al. (45) **Date of Patent:** **** May 31, 2022**

(54) **FUEL SENSOR**

(71) Applicant: **nVent Services GmbH**, Schaffhausen (CH)
(72) Inventors: **Wesley Dong**, Belmont, CA (US); **Jennifer Robison**, San Carlos, CA (US); **Emmi Ngo**, Schaffhausen (CH); **Peter Wijeratne**, San Carlos, CA (US); **Johnny Lam**, Schaffhausen (CH)
(73) Assignee: **nVent Services GmbH**, Schaffhausen (CH)

(**) Term: **15 Years**

(21) Appl. No.: **29/711,665**

(22) Filed: **Nov. 1, 2019**

(51) **LOC (13) Cl.** **10-04**

(52) **U.S. Cl.**
USPC **D10/101**

(58) **Field of Classification Search**
USPC ... D10/106.91, 106.9, 106.4, 46, 47, 61, 62, D10/65, 67, 71, 74-82, 85, 86, 96-103; D19/133

(Continued)

(56) **References Cited**

U.S. PATENT DOCUMENTS

4,333,067 A 6/1982 Kugimiya et al.
4,450,428 A 5/1984 Ohta et al.

(Continued)

FOREIGN PATENT DOCUMENTS

CN 200962099 Y 10/2007
CN 302686710 * 12/2013

(Continued)

OTHER PUBLICATIONS

Aufee, Marking Ruler, Date first available Jul. 13, 2020, [online]retrieved Oct. 15, 2021,available from https://www.amazon.com/dp/B08CV6HC68/ref=sspa_dk_detail_4?psc=1&pd_rd_w=ciBm0&pf_rd_p=9fd3ea7c-b77c-42ac-b43b-c872d3f37c38&pd_rd_wg=t1DVY&pf_rd_r=KJM4Q8E7ZHDQ5NZG9H0H&pd_rd_r=9c879fec-0a1d-4614-9b76-9c (Year: 2020).*

(Continued)

Primary Examiner — Keli L Hill

Assistant Examiner — Sara S Sahneh

(74) *Attorney, Agent, or Firm* — Quarles & Brady LLP

(57) **CLAIM**

The ornamental design for a fuel sensor, as shown and described.

DESCRIPTION

FIG. 1 is a front, top and right side perspective view of a of a fuel sensor, showing our new design;
FIG. 2 is a front side elevational view of the fuel sensor of FIG. 1;
FIG. 3 is a rear side elevational view of the fuel sensor of FIG. 1;
FIG. 4 is a right elevational view of the fuel sensor of FIG. 1;
FIG. 5 is a left elevational view of the fuel sensor of FIG. 1;
FIG. 6 is a top plan view of the fuel sensor of FIG. 1; and
FIG. 7 is a bottom plan view of the fuel sensor of FIG. 1.
The dash-dash broken lines showing a portion of the fuel sensor are for the purpose of illustrating unclaimed portions, and form no part of the claimed design. The dash-dot broken lines illustrate boundary lines, and form no part of the claimed design. The fuel sensor is shown with symbolic breaks in the length of the body in the FIGS. 1 and 4-7 drawing views. It is understood that patentability is based only on those portions of the article that are shown in solid lines, and the appearance of any portion of the article between the break lines forms no part of the claimed design.

1 Claim, 3 Drawing Sheets

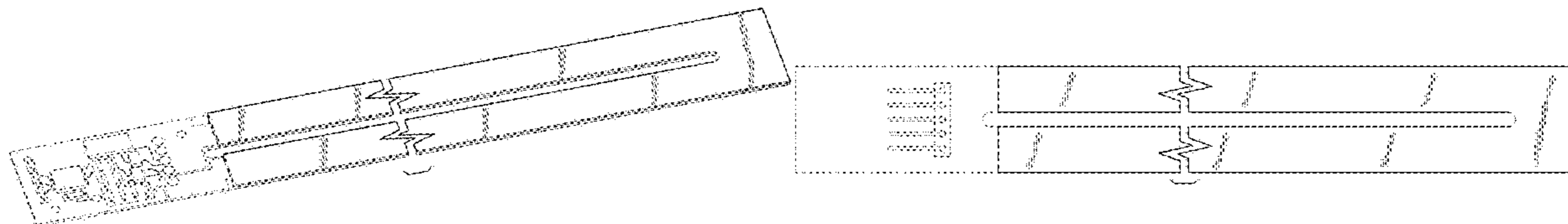

(58) **Field of Classification Search**

CPC A61B 5/14532; A61B 5/14865; A61B 5/6848; G01N 27/416; G01N 27/12; G01N 33/54366; G01N 27/07; G01N 33/28; G01N 27/045; G01N 27/122; G01F 23/24; G01F 23/26; B01L 3/5023; G01B 3/02; G01B 5/00; G01B 5/02; G01C 9/24

See application file for complete search history.

8,677,803 B2 3/2014 Hocken et al.
 8,739,604 B2 6/2014 Krishna et al.
 8,823,400 B2 9/2014 Hocken et al.
 D729,043 S * 5/2015 Poppell D8/354
 9,042,075 B2 5/2015 Borini et al.
 9,523,651 B2 12/2016 Humbert et al.
 9,855,359 B2 1/2018 Liu
 10,018,581 B2 7/2018 Wang et al.
 10,175,221 B2 1/2019 Ciampini
 10,302,635 B2 5/2019 Kobayashi
 10,801,389 B2 * 10/2020 Chung G01N 25/32
 2007/0119233 A1 * 5/2007 Schnell G01N 15/0656
 73/28.01

(56) **References Cited**

U.S. PATENT DOCUMENTS

4,478,067 A 10/1984 Ohta et al.
 4,487,057 A 12/1984 Lutz
 4,499,663 A * 2/1985 Zwick H01M 8/1213
 29/623.1
 4,608,232 A 8/1986 Sunano et al.
 4,693,953 A 9/1987 Torikai
 4,713,646 A 12/1987 Sunano
 4,778,082 A * 10/1988 Vitelle B65D 35/28
 222/103
 4,798,693 A * 1/1989 Mase G01N 27/4071
 204/425
 4,816,800 A 3/1989 Onaga et al.
 4,855,706 A 8/1989 Hauptly
 4,909,066 A 3/1990 Matsuura et al.
 4,942,764 A 7/1990 Dews et al.
 5,006,828 A 4/1991 Yutaka et al.
 5,071,036 A * 12/1991 Kelly B65D 35/28
 222/103
 5,167,348 A * 12/1992 Okami B65D 35/28
 222/102
 5,419,828 A * 5/1995 Nakano G01N 27/4071
 204/425
 5,482,678 A 1/1996 Sittier
 5,578,997 A 11/1996 Lechevalier
 5,670,115 A 9/1997 Chen et al.
 5,743,136 A 4/1998 Gaston et al.
 5,804,699 A * 9/1998 Sugiyama G01N 27/417
 73/23.32
 D407,253 S * 3/1999 Smith D6/541
 6,615,659 B2 9/2003 Shibue et al.
 6,705,152 B2 3/2004 Routkevitch et al.
 7,025,849 B2 4/2006 Kim et al.
 7,033,457 B2 4/2006 Kim et al.
 7,113,069 B1 9/2006 Sunshine
 D551,538 S * 9/2007 Pearce D8/354
 D599,193 S * 9/2009 Meyer D8/354
 D599,194 S * 9/2009 Meyer D8/354
 D608,183 S * 1/2010 Meyer D8/354
 7,827,852 B2 11/2010 Cui et al.
 7,829,185 B2 11/2010 Cuppoletti
 7,859,273 B2 12/2010 McCoy et al.
 D649,863 S * 12/2011 Meyer D8/354
 8,419,961 B2 4/2013 Qin
 8,429,952 B1 4/2013 Bringhurst et al.
 8,586,394 B2 11/2013 Fosaaen
 8,614,118 B2 12/2013 Haji et al.
 8,640,526 B2 2/2014 Di Miro et al.
 8,673,213 B2 3/2014 Augstein et al.

2009/0029403 A1 1/2009 Fleischer et al.
 2009/0090179 A1 4/2009 Carmona et al.
 2010/0025238 A1 2/2010 Gottlieb et al.
 2010/0219849 A1 * 9/2010 McCoy G01N 27/122
 324/693
 2011/0079078 A1 * 4/2011 Ho G01F 23/268
 73/304 C
 2012/0156688 A1 6/2012 McAlpine et al.
 2013/0048627 A1 * 2/2013 Satou H05B 3/06
 219/552
 2013/0233708 A1 * 9/2013 Sakuma G01N 27/4071
 204/408
 2014/0326602 A1 * 11/2014 Pachinger G01N 27/4073
 204/424
 2016/0169831 A1 * 6/2016 Wang G01N 27/4075
 204/424
 2016/0238548 A1 8/2016 Aguir et al.
 2017/0010258 A1 1/2017 Davis et al.
 2018/0038815 A1 2/2018 Gu et al.
 2019/0265189 A1 * 8/2019 Shimizu G01N 27/4071
 2021/0063337 A1 * 3/2021 Dong G01N 27/122

FOREIGN PATENT DOCUMENTS

CN 103604839 A 2/2014
 CN 303690117 * 6/2016
 CN 106687811 A 5/2017
 CN 107144370 A 9/2017
 EM 002213876-0005 * 4/2013
 EM 002646349-0001 * 3/2015
 EM 004109908-0004 * 7/2017
 EP 1953539 B1 12/2017
 GB 9008014716-0001 * 6/2020
 JP S57133345 A 8/1982
 JP 5936087 B2 5/2016
 KR 2006021822 A 3/2006
 KR 300851474.0000 * 10/2015
 WO 0233732 A2 4/2002
 WO 03012390 A2 2/2003
 WO 2005073703 A1 8/2005
 WO 2018126326 A1 7/2018
 WO 2019053460 A1 3/2019

OTHER PUBLICATIONS

NVent|RAYCHEM, Fast Fuel Sensor Probe with Leader Cable, No Connector, specifications, Copyright 2020 nVent, 2 pages.

* cited by examiner

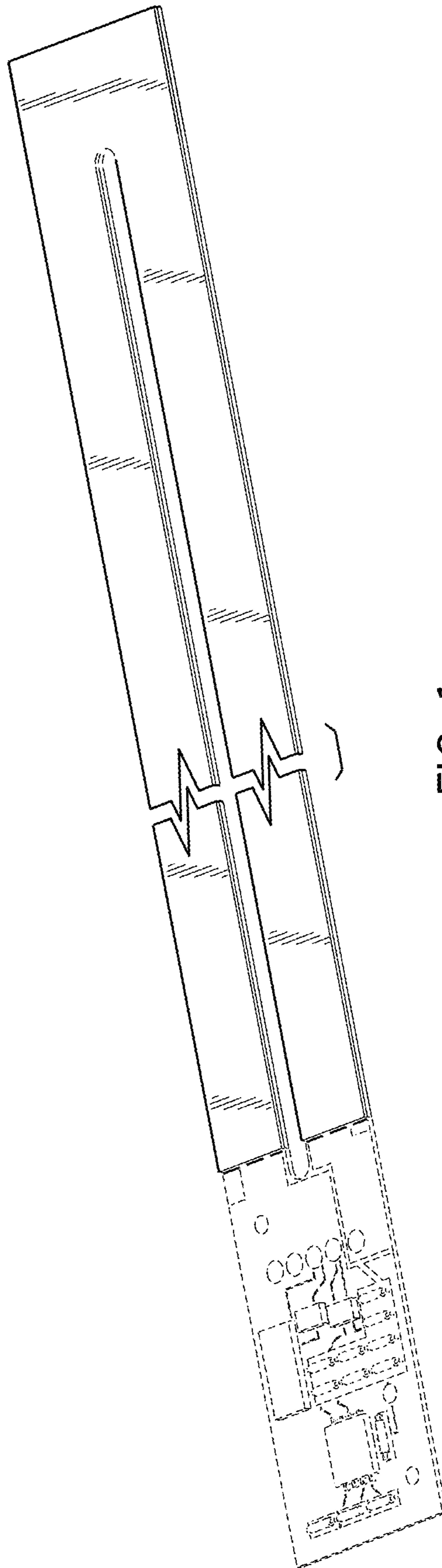

FIG. 1

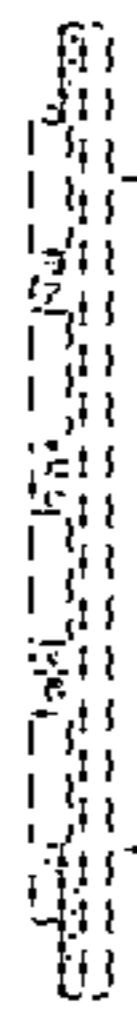

FIG. 2



FIG. 3

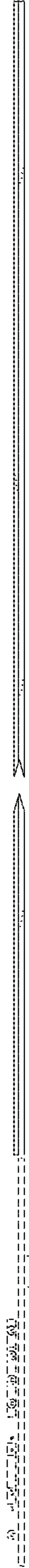

FIG. 4

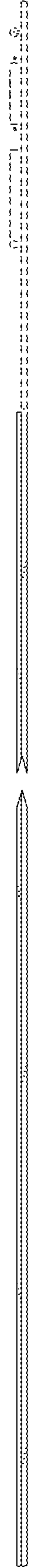

FIG. 5

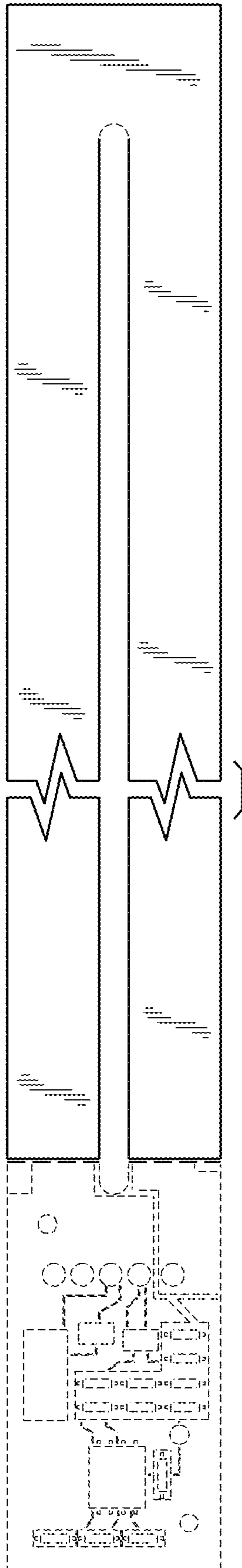

FIG. 6

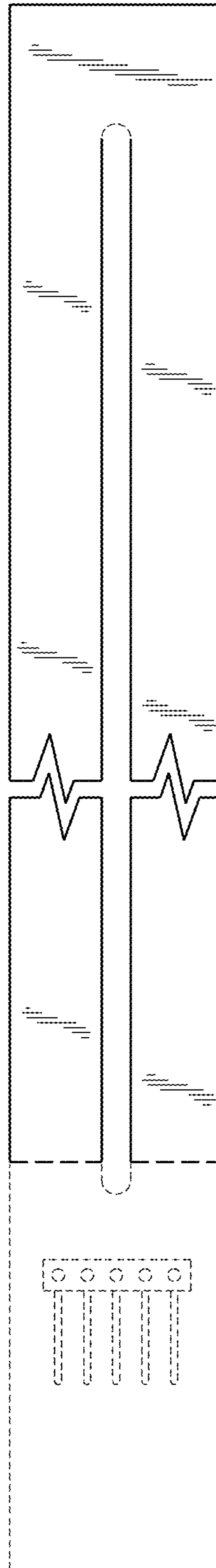

FIG. 7