



US00D953167S

(12) **United States Design Patent**
Otani et al.

(10) **Patent No.:** **US D953,167 S**

(45) **Date of Patent:** **** May 31, 2022**

(54) **COSMETIC BOTTLE**

(71) Applicant: **ELC MANAGEMENT LLC**, Melville,
NY (US)

(72) Inventors: **Laura Otani**, New York, NY (US);
Maria Portiansky, Brooklyn, NY (US);
Judith Shalva Waletzky, Brooklyn,
NY (US)

(73) Assignee: **ELC MANAGEMENT LLC**, Melville,
NY (US)

(**) Term: **15 Years**

(21) Appl. No.: **29/715,975**

(22) Filed: **Dec. 5, 2019**

(51) **LOC (13) Cl.** **09-01**

(52) **U.S. Cl.**
USPC **D9/560; D9/454**

(58) **Field of Classification Search**
USPC D9/434-435, 444-445, 447-448, 454,
D9/516, 520, 529, 560, 574, 682, 694,
D9/715-719, 766, 768; D4/114, 116;
D28/73, 76

CPC B65D 1/00; B65D 1/02; B65D 1/0223;
B65D 1/10; B65D 23/00; B65D 2501/00;
B65D 2501/0009; B65D 2501/0081

See application file for complete search history.

(56) **References Cited**

U.S. PATENT DOCUMENTS

D310,329 S * 9/1990 Schmidt D9/454
D434,645 S * 12/2000 Adachi D9/694
D451,812 S * 12/2001 Colonna de Giovellina . D9/516
D530,216 S * 10/2006 Modjeski D9/566
D603,717 S * 11/2009 Rica D9/560
D604,175 S * 11/2009 Rica D9/560
D696,130 S * 12/2013 Zabari D9/529
D705,663 S * 5/2014 Guichot D9/544
D718,639 S * 12/2014 Guichot D9/663

D723,934 S * 3/2015 Kim D9/691
D741,720 S * 10/2015 Anandani D9/560
D756,234 S * 5/2016 Orset D9/560
D763,094 S * 8/2016 Aussel F02K 9/08
D9/574
D766,093 S * 9/2016 Otani D9/560
D777,037 S * 1/2017 Serafin D9/560
D833,291 S * 11/2018 Staab D9/560
D844,444 S * 4/2019 Otani D9/558
D852,059 S * 6/2019 Nagata D9/690
D858,306 S * 9/2019 Nagata D9/690
D863,972 S * 10/2019 Staab D9/560
D873,147 S * 1/2020 Aboabdo D9/560

(Continued)

OTHER PUBLICATIONS

<https://www.telegraph.co.uk/beauty/overnight-skincare/night-time-routine-best-product/> The Telegraph; The One Product Your Night-Time Beauty Routine Is Missing; Catherine Hufton; published on Nov. 18, 2019.

(Continued)

Primary Examiner — Dana Meyrow

(74) *Attorney, Agent, or Firm* — Phoenix S. Pak

(57) **CLAIM**

The ornamental design for a cosmetic bottle, as shown and described herein.

DESCRIPTION

FIG. 1 is a top perspective view of a cosmetic bottle showing the claimed design;

FIG. 2 is a bottom perspective view thereof;

FIG. 3 is a front view thereof;

FIG. 4 is a rear view thereof;

FIG. 5 is a left view thereof;

FIG. 6 is a right view thereof;

FIG. 7 is a top view thereof; and,

FIG. 8 is a bottom view thereof.

1 Claim, 5 Drawing Sheets

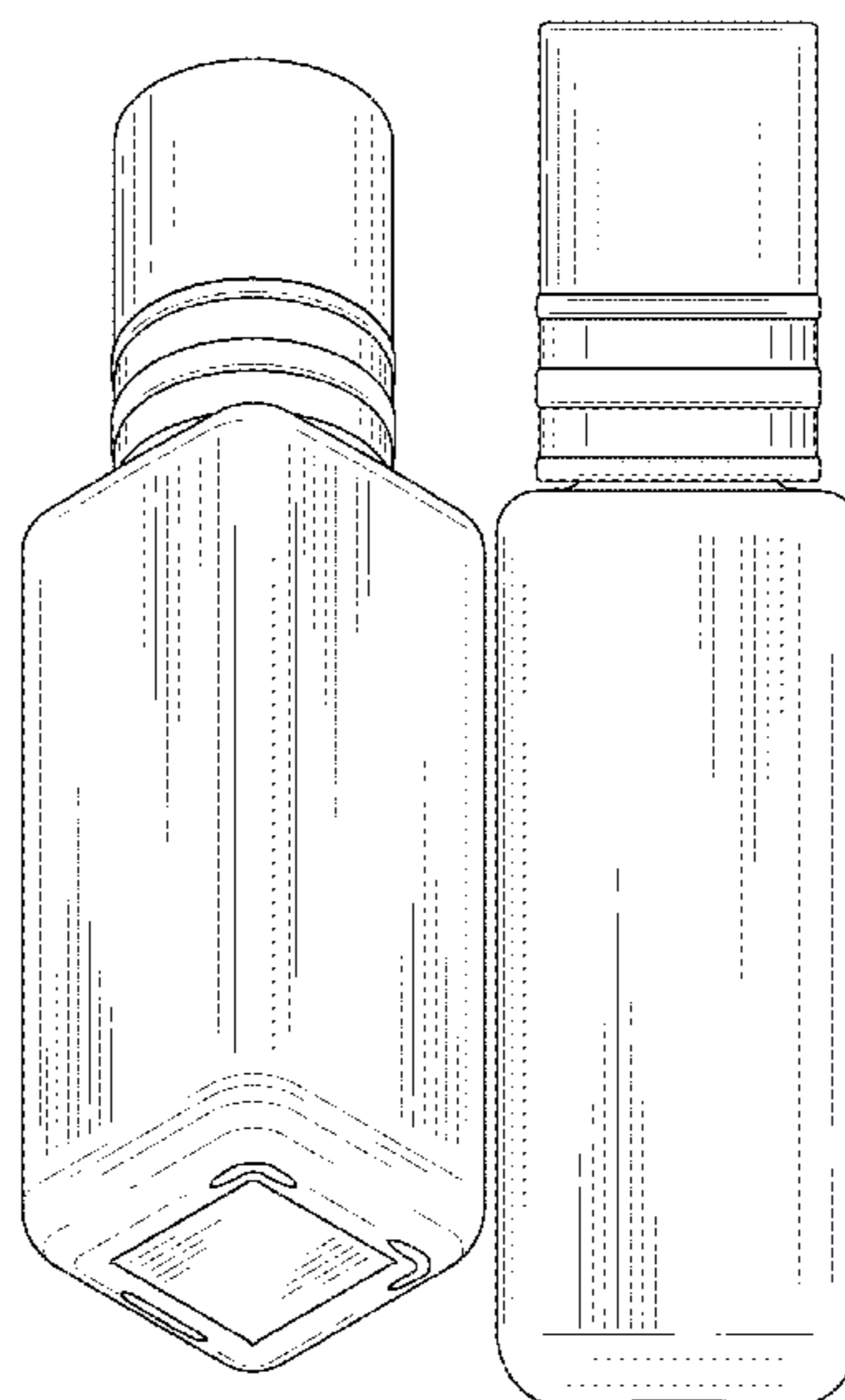

(56)

References Cited

U.S. PATENT DOCUMENTS

D889,966 S * 7/2020 Gautier D9/454
 D924,694 S * 7/2021 Otani D9/723

OTHER PUBLICATIONS

<https://cnalifestyle.channelnewsasia.com/style/how-to-tackle-skin-inflammation-estee-lauder-anr-intense-reset-11648398> CNA Lifestyle; Style & Beauty; Face Value: It is Now Possible to Soothe Sensitive, Irritable Skin in Just One Hour; Serene Seow; published on Jul. 7, 2019.

<https://www.facebook.com/EsteeLauder/photos/10158551628562619> Facebook; Estee Lauder: Estee Lauder Advanced Night Repair; published on Jul. 17, 2019.

https://www.facebook.com/EsteeLauderSG/photos/p.2773702902643317/2773702902643317/?opaqueCursor=AbpLWePF8twmRTjWMoaR53i8NC2pkbzTZnBsi-7-6eUa2SntbTTsipHDDDRdcknOOVfeFjxMuv7kd6WA0iFYM6-uz0_-3m7r201UN Facebook; Estee Lauder Singapore; Advanced Night Repair; published on Aug. 28, 2019.

https://www.facebook.com/Jebandotcom/photos/p.10156465398052045/10156465398052045?opaqueCursor=AbeTb1EAqr6nDwZMM9ulubkNiW5xQrpYNV2iv_xCbTqHZC21ANA4grQBbtXRfk_

R9gZsQzMk6KgxEcfHSxm4bC0DbfpFJN3adEDIA Facebook; Jeban.com; Estee Lauder Advanced Night Repair; published on Aug. 26, 2019.

https://www.facebook.com/MyFreeProductSamples/photos/p.10156429420295878/10156429420295878?opaqueCursor=AbgLL5Z7HCDK4pMj1IPJ2mLjZDumRWWXCFEB5yHHfwhHg83PCfhf-Gj6BIgfYiUdgJcDKvfQTyDY_UJxOIUqERY_rICf Facebook; My Free Product Samples; Estee Lauder Advanced Night Repair; published on Jun. 20, 2019.

<https://www.instagram.com/p/B03PWoy04kG/> Instagram; advancednightrepairconcentrate hashtag on Instagram Photos and Videos; Serena di ban (@seryskinlover_); published on Aug. 7, 2019.

<https://www.instagram.com/p/Bys-p4SFD8d/> Instagram Estee Lauder (@esteelauder); Instagram photos and videos; published on Jun. 15, 2019.

<https://www.youtube.com/watch?v=6aWX1hA6wIQ> YouTube; Estee Lauder Malaysia, Press Reset Tonight New Advanced Night Repair Intense Reset Concentrate; published on Aug. 1, 2019.

https://www.youtube.com/watch?v=C_TYg8quGO0 YouTube; Beauty Intrend; Estee Lauder New Advanced Night Repair Intense Reset Concentrate; published on Aug. 9, 2019.

https://www.instagram.com/p/B01_HhQBmf5/ Instagram Estee Lauder Japan (@esteelauderjp); Instagram photos and videos; published on 7 Aug. 2019.

Taiwanese Search Report from TW Application No. 109303023 document dated Jun. 17, 2021.

* cited by examiner

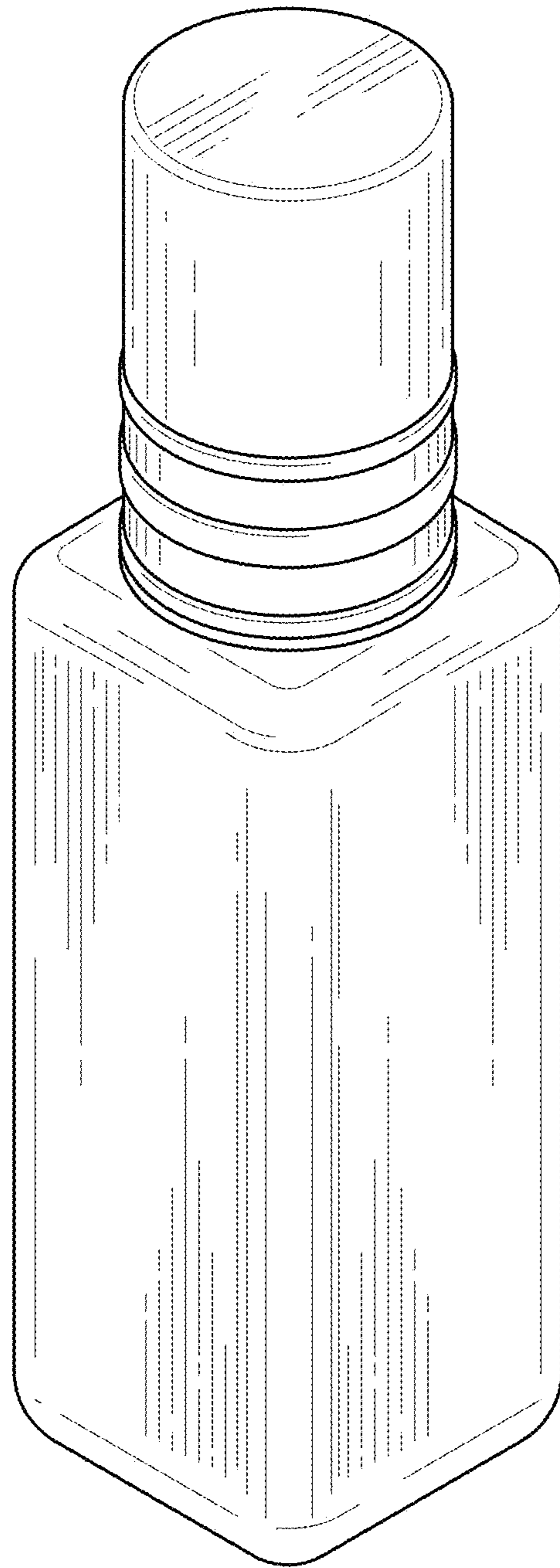

FIG. 1

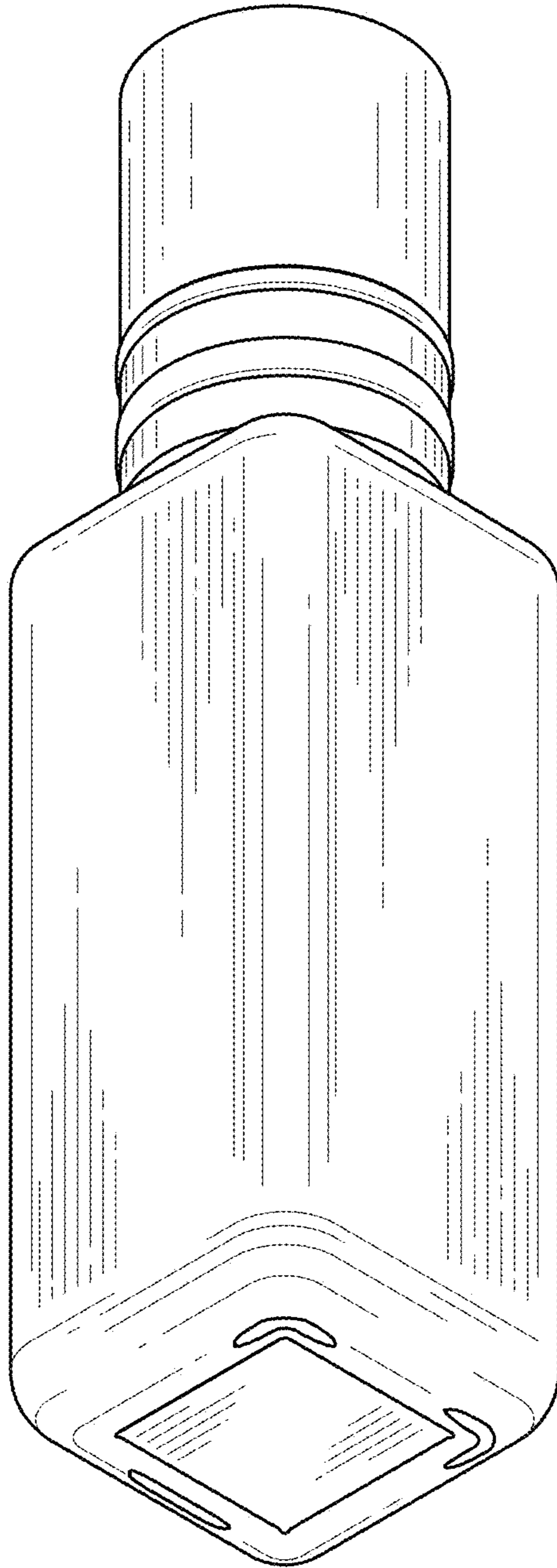

FIG. 2

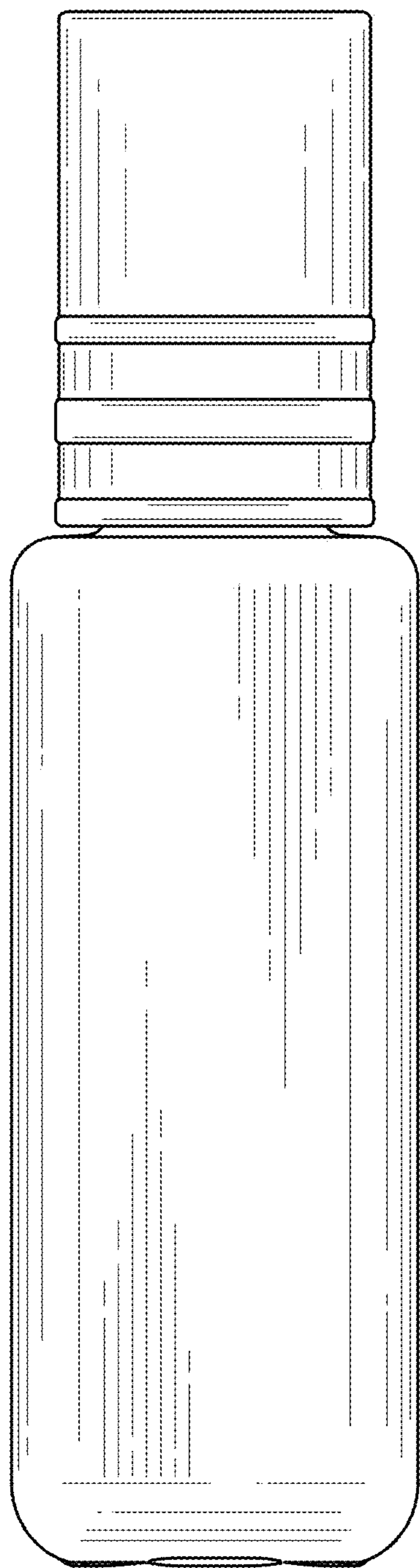

FIG. 3

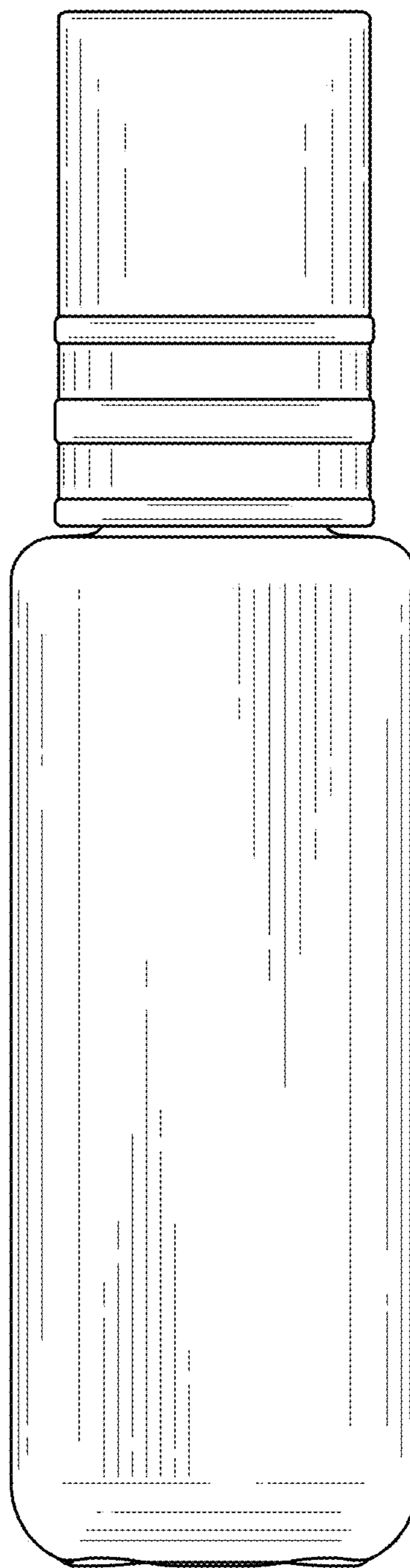

FIG. 4

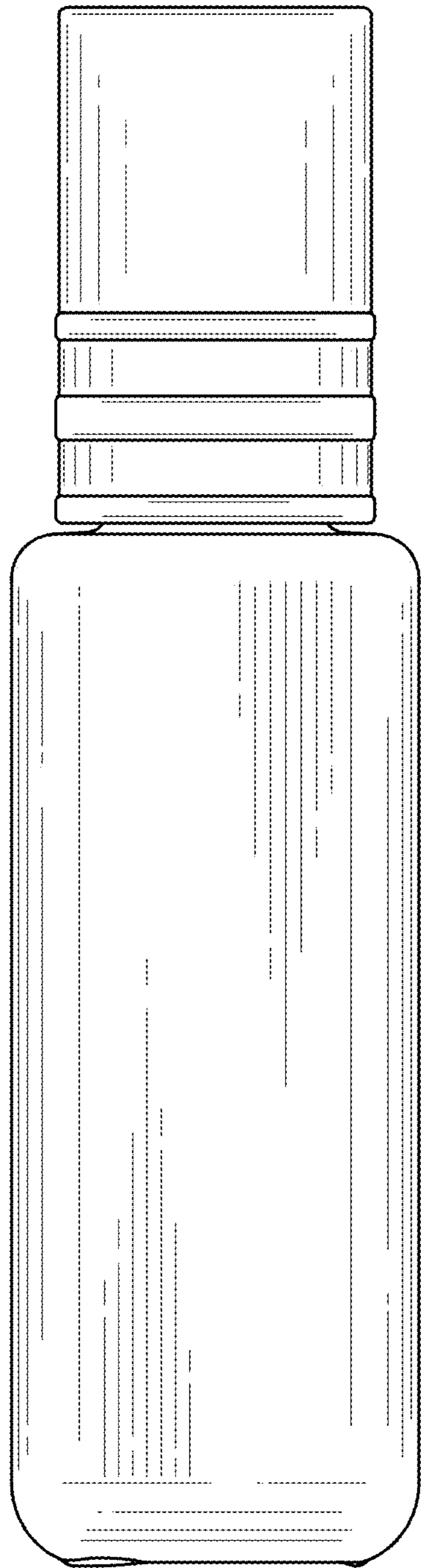

FIG. 5

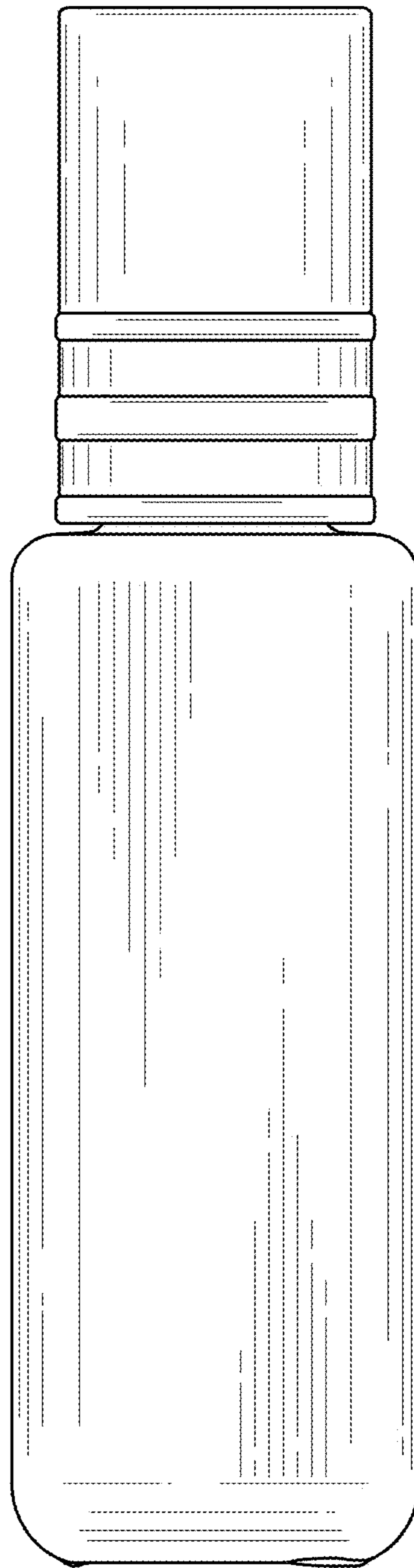

FIG. 6

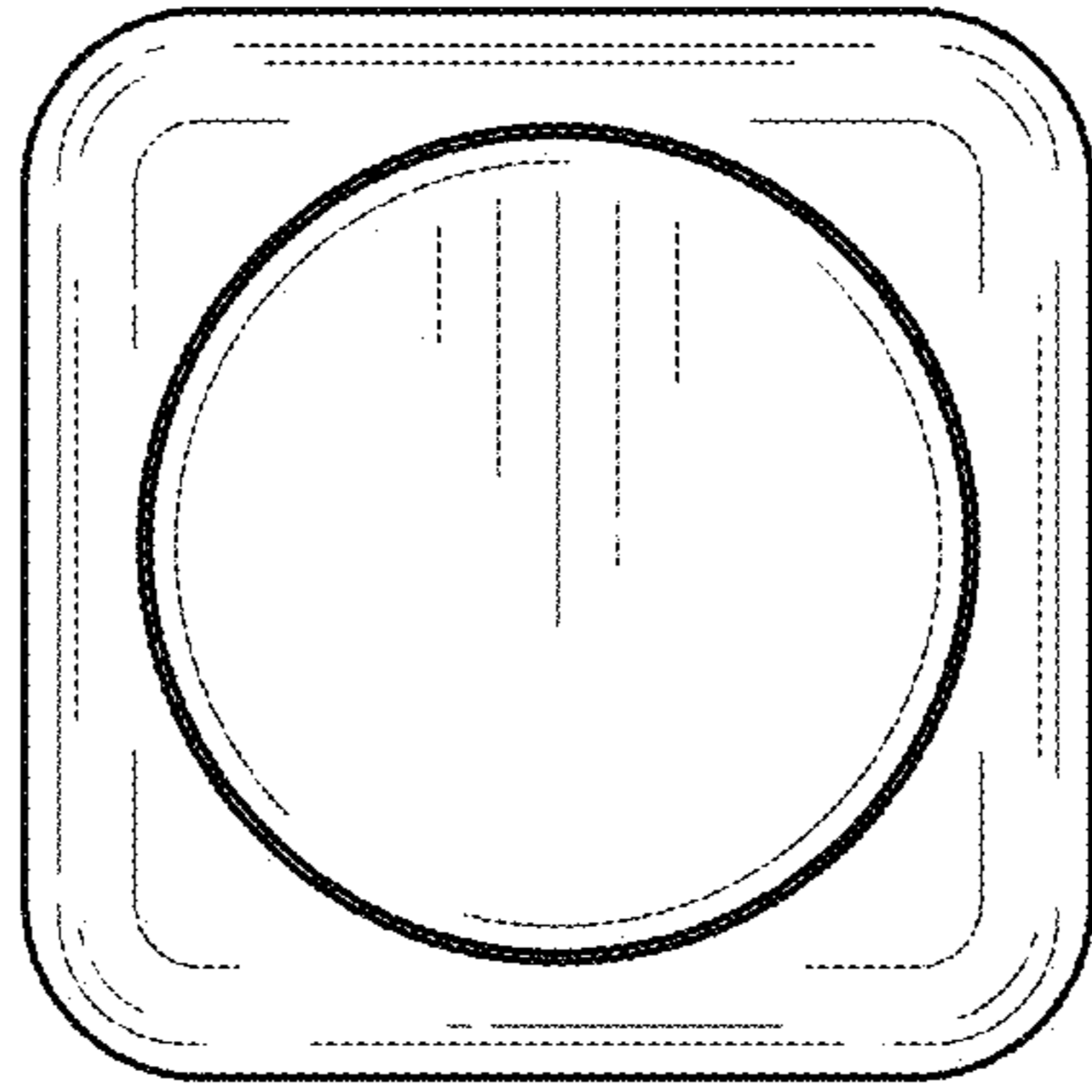

FIG. 7

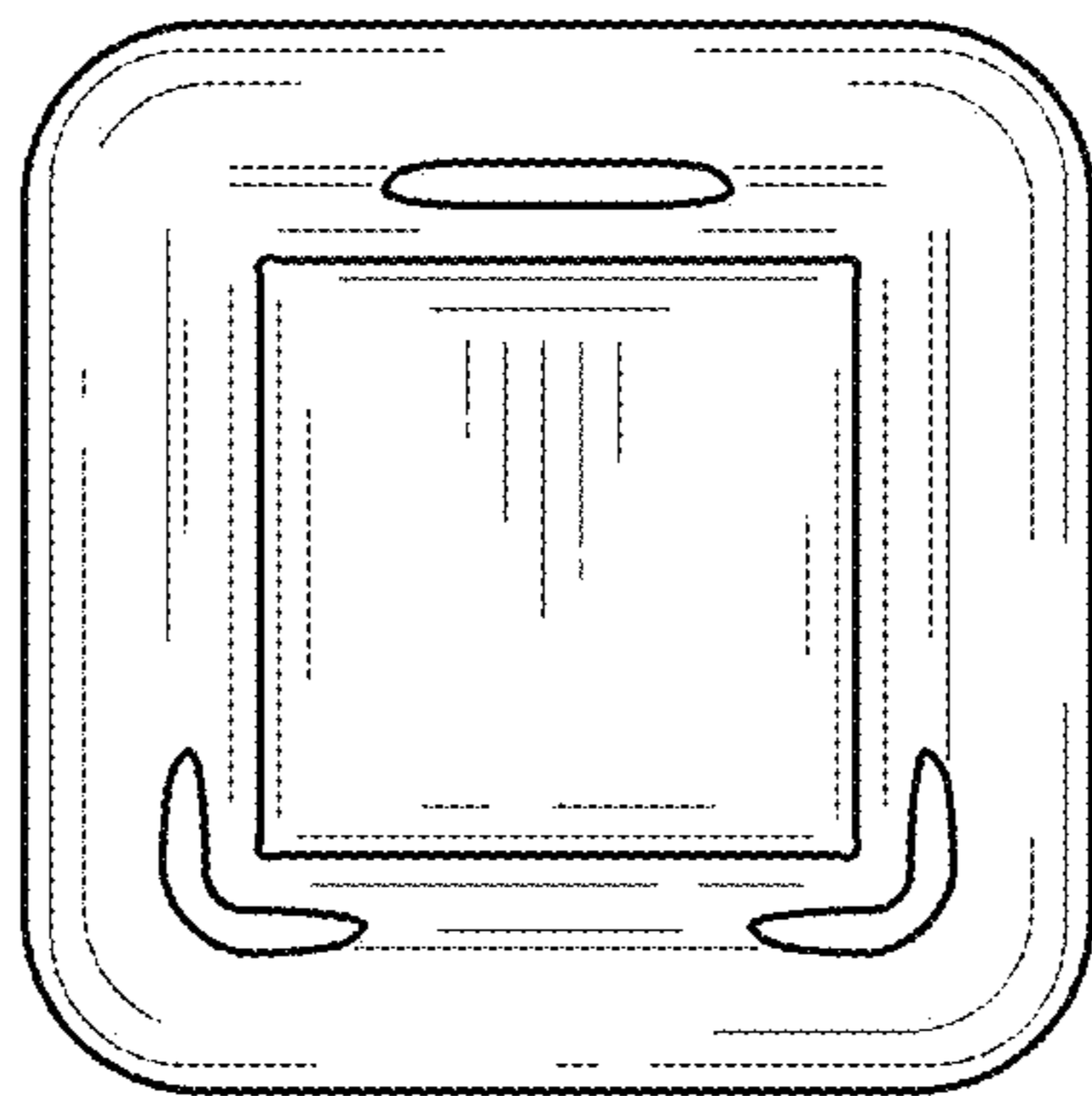

FIG. 8