



US00D953098S

(12) **United States Design Patent**
Guo et al.

(10) **Patent No.:** **US D953,098 S**

(45) **Date of Patent:** **** May 31, 2022**

(54) **FOOD PROCESSOR**

(71) Applicant: **MIDEA GROUP CO., LTD.**,
Guangdong (CN)

(72) Inventors: **Yuqiang Guo**, Guangdong (CN);
Xian'an Liu, Guangdong (CN); **Weixi Peng**, Guangdong (CN)

(73) Assignee: **MIDEA GROUP CO., LTD.**,
Guangdong (CN)

(**) Term: **15 Years**

(21) Appl. No.: **35/511,128**

(22) Filed: **Oct. 19, 2020**

(80) **Hague Agreement Data**

Int. Filing Date: **Oct. 19, 2020**

Int. Reg. No.: **DM/211970**

Int. Reg. Date: **Oct. 19, 2020**

Int. Reg. Pub. Date: **Jan. 15, 2021**

(30) **Foreign Application Priority Data**

May 25, 2020 (CN) 202030246049.1

(51) **LOC (13) Cl.** **31-00**

(52) **U.S. Cl.**
USPC **D7/384**

(58) **Field of Classification Search**

USPC D7/368, 665, 679, 688, 693, 372, 381,
D7/384

CPC .. A47J 43/00; A47J 43/24; A47J 43/04; A47J
43/044; A47J 2043/04454; A47J 43/07;
A47J 43/0722; A47J 43/08; A47J 43/085;
A47J 43/1075

See application file for complete search history.

(56) **References Cited**

U.S. PATENT DOCUMENTS

D290,331 S * 6/1987 Tabah D7/372

D359,422 S * 6/1995 Joergensen D7/679

D378,182 S * 2/1997 Wong D7/693
D399,709 S * 10/1998 Lee D7/665
D419,834 S * 2/2000 Lai D7/665
6,018,883 A * 2/2000 Mulhauser F26B 5/08
494/60
D421,368 S * 3/2000 Lai D7/665
D427,011 S * 6/2000 Yip D7/384
6,070,519 A * 6/2000 Sham A47J 19/023
99/503
D427,857 S * 7/2000 Mulhauser D7/665
D437,188 S * 2/2001 Thackray D7/665
D462,881 S * 9/2002 Mulhauser D7/665
6,473,988 B1 * 11/2002 Mulhauser A47J 43/24
34/127
6,622,618 B1 * 9/2003 Glucksman A47J 43/24
494/60
D481,271 S * 10/2003 Herren D7/693
D506,903 S * 7/2005 Lee D7/665
D511,434 S * 11/2005 Feil D7/384
D518,688 S * 4/2006 Overthun D7/693
D519,791 S * 5/2006 Bodum D7/679
D527,588 S * 9/2006 de Groot D7/693
D530,989 S * 10/2006 Mellen D7/665
D530,995 S * 10/2006 Jalet D7/693

(Continued)

Primary Examiner — Steven J Czyz

(57) **CLAIM**

The ornamental design for a food processor, as shown and described.

DESCRIPTION

- 1. Food processor
- 1.1 : Front
- 1.2 : Back
- 1.3 : Left
- 1.4 : Right
- 1.5 : Top
- 1.6 : Bottom
- 1.7 : Perspective

1 Claim, 7 Drawing Sheets

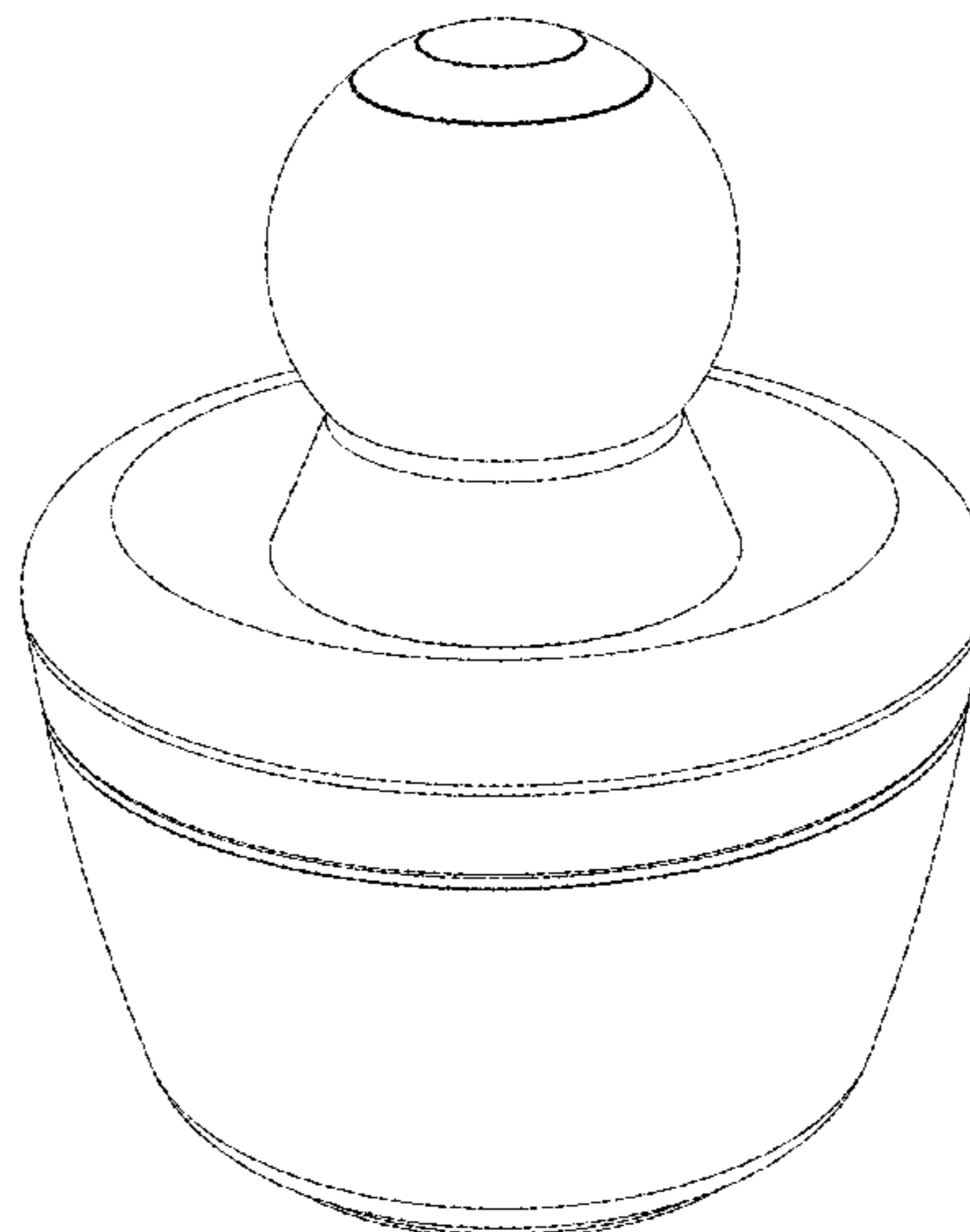

(56)

References Cited

U.S. PATENT DOCUMENTS

D538,604 S * 3/2007 de Groote D7/665
 D538,605 S * 3/2007 Wan D7/665
 D538,606 S * 3/2007 Hood D7/665
 D608,603 S * 1/2010 Hauser D7/665
 D609,981 S * 2/2010 Jossem D7/665
 D651,871 S * 1/2012 Coursey D7/693
 D682,048 S * 5/2013 Perry D7/665
 8,539,693 B2 * 9/2013 Perry F16D 53/00
 34/317
 D694,073 S * 11/2013 Vincenti D7/665
 D708,903 S * 7/2014 Wong D7/378
 D725,960 S * 4/2015 Fu D7/381
 D732,353 S * 6/2015 Wong D7/665
 D740,620 S * 10/2015 Chen D7/665
 D747,621 S * 1/2016 Amerson D7/354
 D753,962 S * 4/2016 Cornu D7/665
 D769,677 S * 10/2016 Shamoon D7/665
 D776,499 S * 1/2017 Verbrugge D7/381
 D813,618 S * 3/2018 Witko D7/679
 D826,009 S * 8/2018 Feng D7/665
 D829,062 S * 9/2018 O'Leary D7/665
 D838,560 S * 1/2019 Wong D7/693
 D843,796 S * 3/2019 Wong D7/693
 D864,677 S * 10/2019 Brouillac D7/679
 D881,659 S * 4/2020 O'Leary D7/665
 D887,210 S * 6/2020 Fung D7/378

D896,596 S * 9/2020 Kent D7/372
 D900,531 S * 11/2020 Chen A47J 43/24
 D7/381
 D900,533 S * 11/2020 Chen D7/693
 D906,066 S * 12/2020 Lu D7/693
 D909,828 S * 2/2021 Brouillac D7/679
 D938,788 S * 12/2021 Zhong D7/679
 D942,799 S * 2/2022 Chen D7/378
 D942,801 S * 2/2022 Chen D7/378
 11,266,270 B2 * 3/2022 Hammond et al. A47J 43/07
 2003/0099154 A1 * 5/2003 Daniels, Jr. A47J 43/0727
 366/205
 2004/0149843 A1 * 8/2004 Tang A47J 43/044
 241/272
 2005/0204935 A1 * 9/2005 Siegel A47J 43/24
 99/495
 2012/0155215 A1 * 6/2012 Verma A47J 43/044
 366/199
 2012/0246959 A1 * 10/2012 Perry F16D 65/18
 34/58
 2013/0092773 A1 * 4/2013 Verheem B26D 3/26
 241/169
 2014/0360535 A1 * 12/2014 Andrus A47J 43/24
 134/199
 2015/0129002 A1 * 5/2015 Park A47L 15/23
 134/140
 2016/0095474 A1 * 4/2016 Hauser A47J 43/24
 99/495

* cited by examiner

1.1

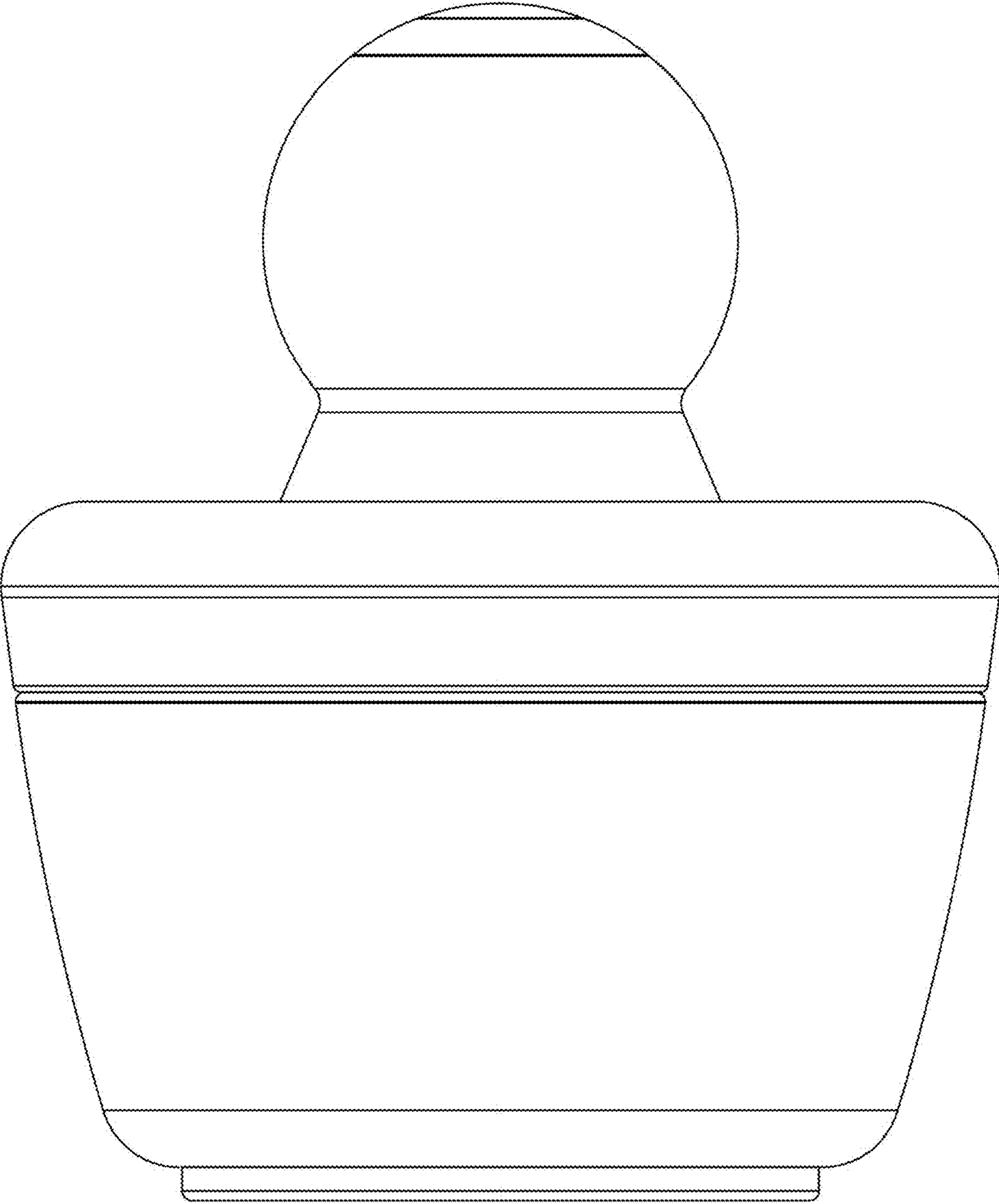

1.2

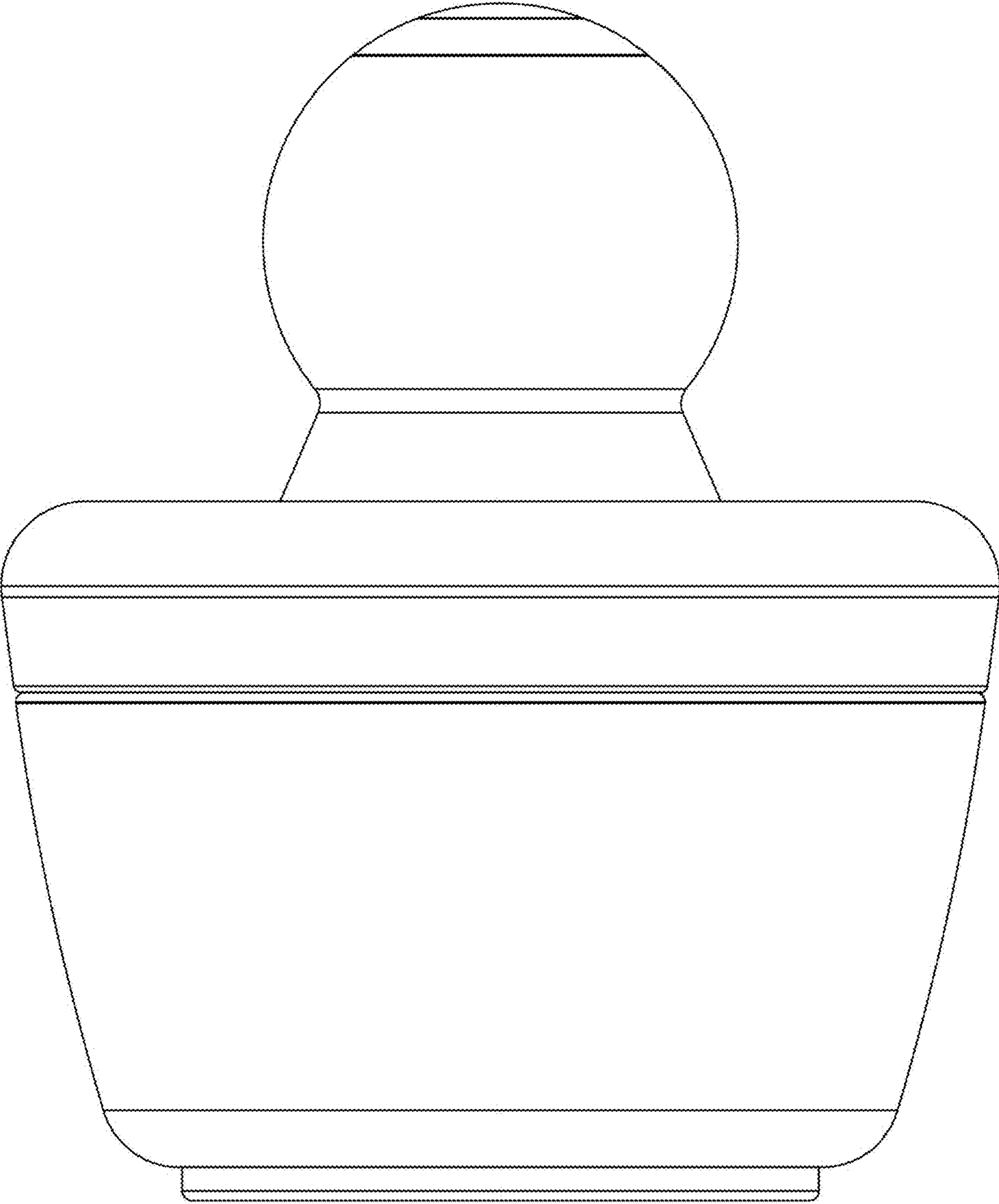

1.3

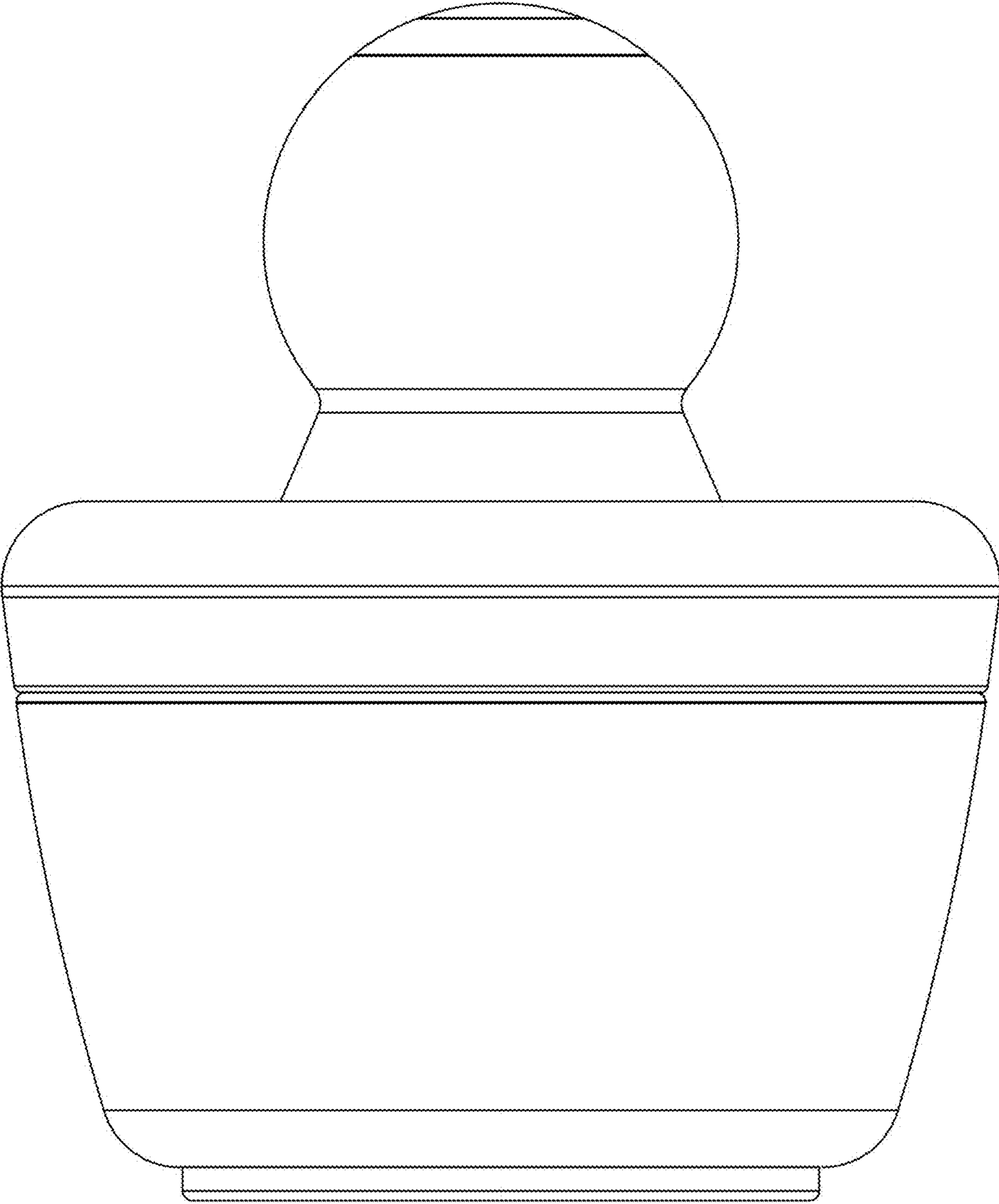

1.4

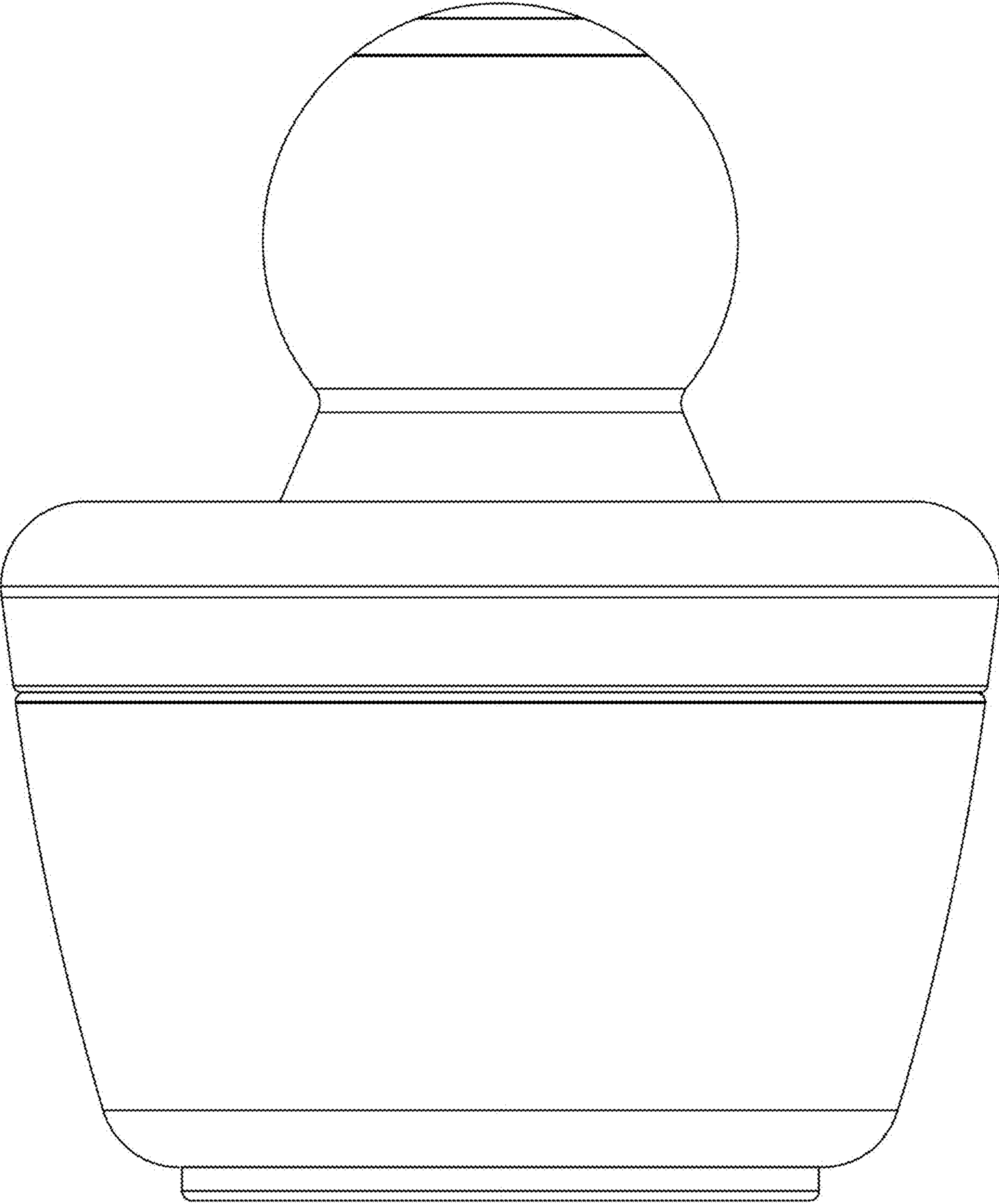

1.5

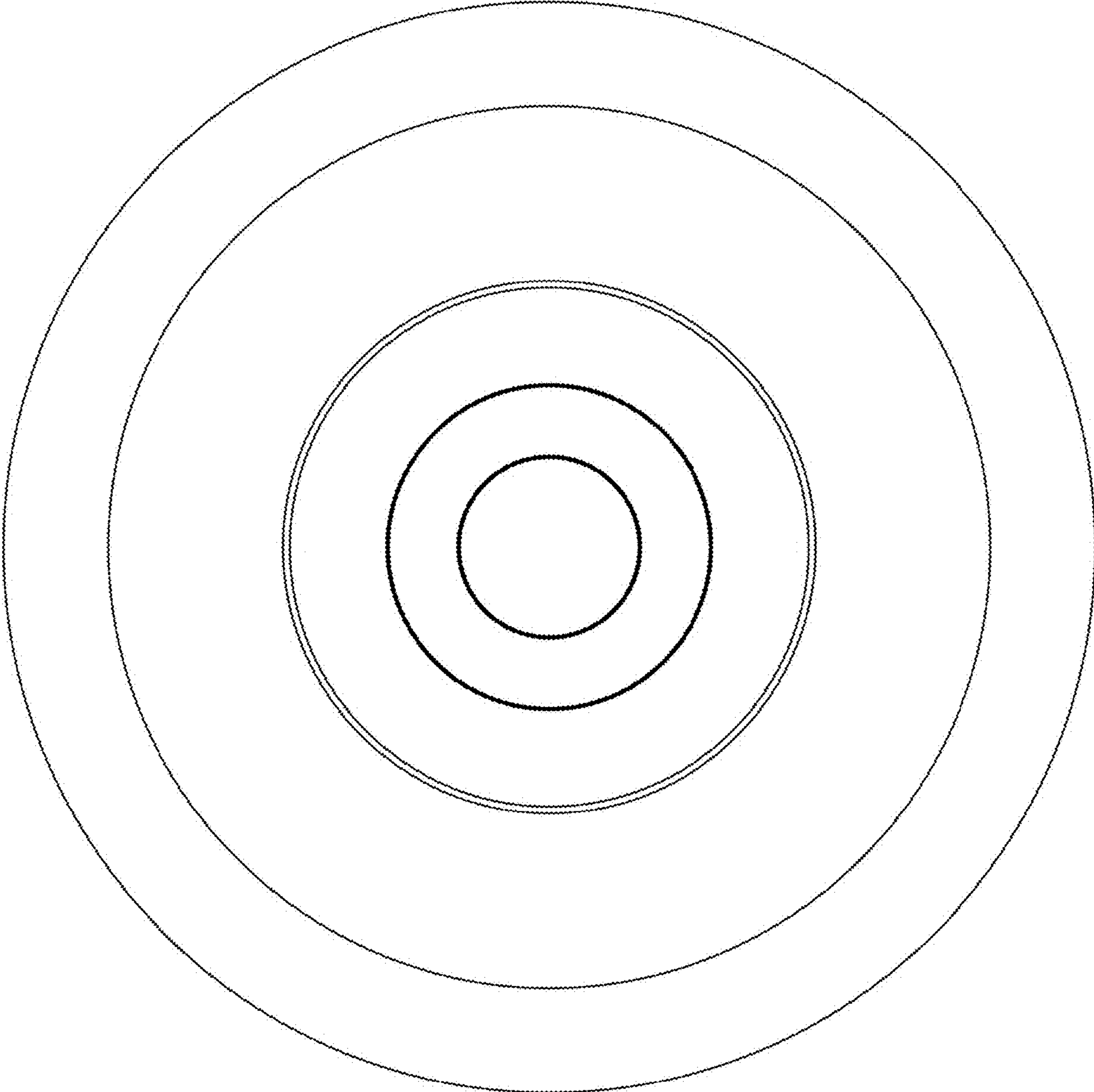

1.6

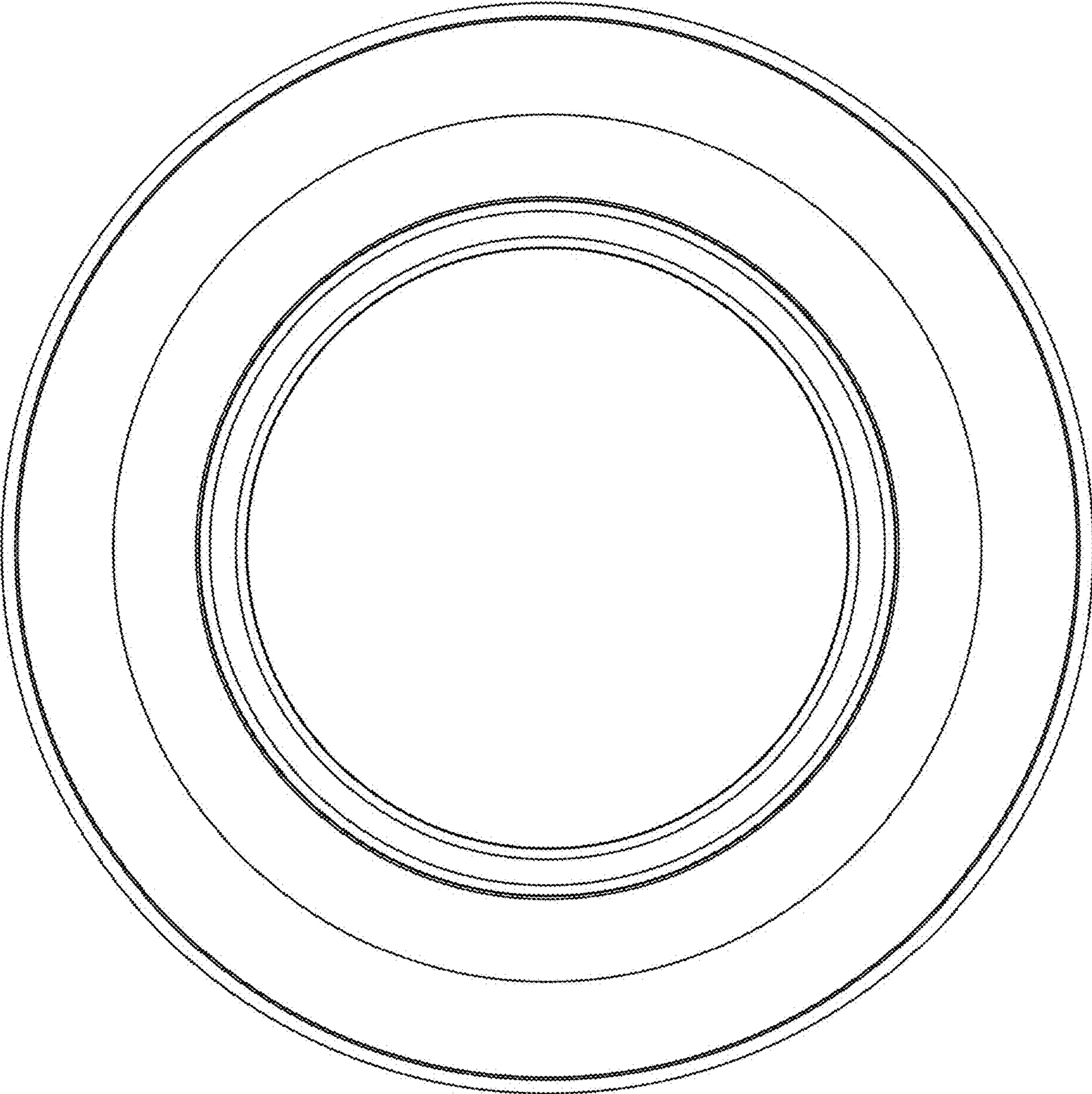

1.7

