



US00D953093S

(12) **United States Design Patent**  
**Fang et al.**

(10) **Patent No.:** **US D953,093 S**

(45) **Date of Patent:** **\*\* May 31, 2022**

(54) **AIR FRYER**  
(71) Applicant: **MIDEA GROUP CO., LTD.**,  
Guangdong (CN)  
(72) Inventors: **Zhou Fang**, Guangdong (CN); **Wengan Liang**, Guangdong (CN)  
(73) Assignee: **MIDEA GROUP CO., LTD.**,  
Guangdong (CN)  
(\*\*) Term: **15 Years**  
(21) Appl. No.: **35/511,139**  
(22) Filed: **Oct. 9, 2020**  
(80) **Hague Agreement Data**  
Int. Filing Date: **Oct. 9, 2020**  
Int. Reg. No.: **DM/212061**  
Int. Reg. Date: **Oct. 9, 2020**  
Int. Reg. Pub. Date: **Jan. 15, 2021**

(30) **Foreign Application Priority Data**  
May 27, 2020 (CN) ..... 202030252687.4  
(51) **LOC (13) Cl.** ..... **07-02**  
(52) **U.S. Cl.**  
USPC ..... **D7/354**  
(58) **Field of Classification Search**  
USPC ..... D7/300.1, 318, 319, 348, 350.1, 354,  
D7/362, 402, 509, 510, 511, 533, 604,  
D7/609, 611, 615, 649, 652, 653, 664,  
D7/671, 672, 674, 683, 691, 698, 701,  
D7/703, 708  
CPC . A21B 2/00; A47J 43/27; A47G 19/22; H05B  
6/64  
See application file for complete search history.

(56) **References Cited**  
U.S. PATENT DOCUMENTS  
D369,270 S \* 4/1996 Payen ..... A47J 37/0641  
D7/354  
D424,366 S \* 5/2000 Blaise ..... D7/354

D436,795 S \* 1/2001 Martres ..... D7/354  
D452,795 S \* 1/2002 Johnson ..... D7/354  
6,499,390 B1 \* 12/2002 Huang ..... A47J 37/1209  
220/314  
D474,937 S \* 5/2003 Josancy ..... D7/354  
D533,014 S \* 12/2006 Choi ..... D7/354  
D533,393 S \* 12/2006 Sidet ..... D7/354  
D610,866 S \* 3/2010 Fiorotto ..... D7/354  
D677,112 S \* 3/2013 Piret ..... D7/354  
D801,103 S \* 10/2017 Krooshof ..... A47J 37/0641  
D7/354  
D816,390 S \* 5/2018 Zhang ..... D7/354  
D820,030 S \* 6/2018 Zhang ..... D7/354  
D848,199 S \* 5/2019 Kowalewski ..... A47J 37/1209  
D7/354  
D848,200 S \* 5/2019 Kowalewski ..... A47J 36/38  
D7/354  
D904,103 S \* 12/2020 Krause ..... D7/354  
2020/0008616 A1 \* 1/2020 Moon ..... A47J 36/38

\* cited by examiner

*Primary Examiner* — Karen S Acker

(57) **CLAIM**

The ornamental design for an air fryer, as shown and described.

**DESCRIPTION**

- 1. Air fryer
- 1.1 : Front
- 1.2 : Back
- 1.3 : Left
- 1.4 : Right
- 1.5 : Top
- 1.6 : Bottom
- 1.7 : Perspective

**1 Claim, 7 Drawing Sheets**

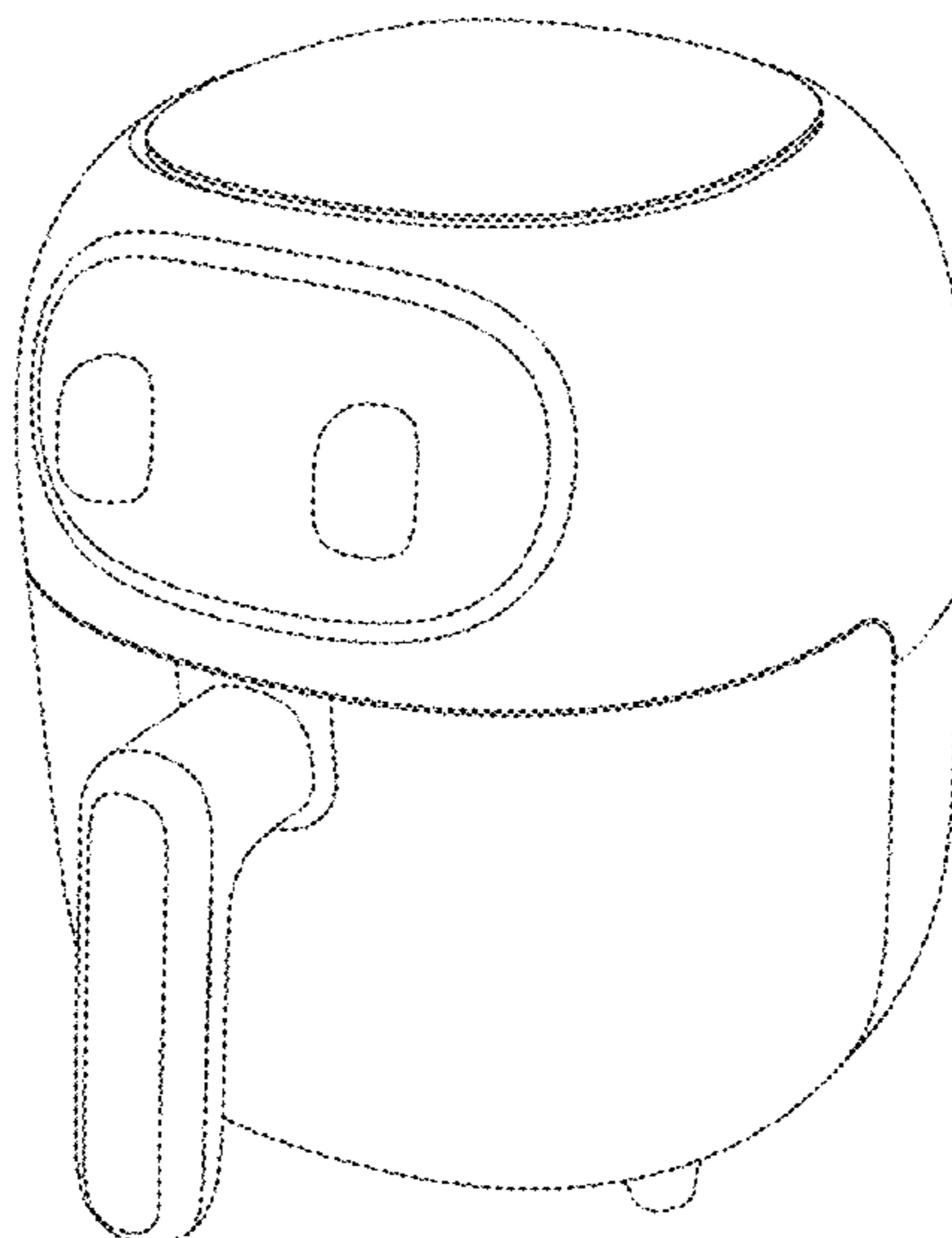

1.1

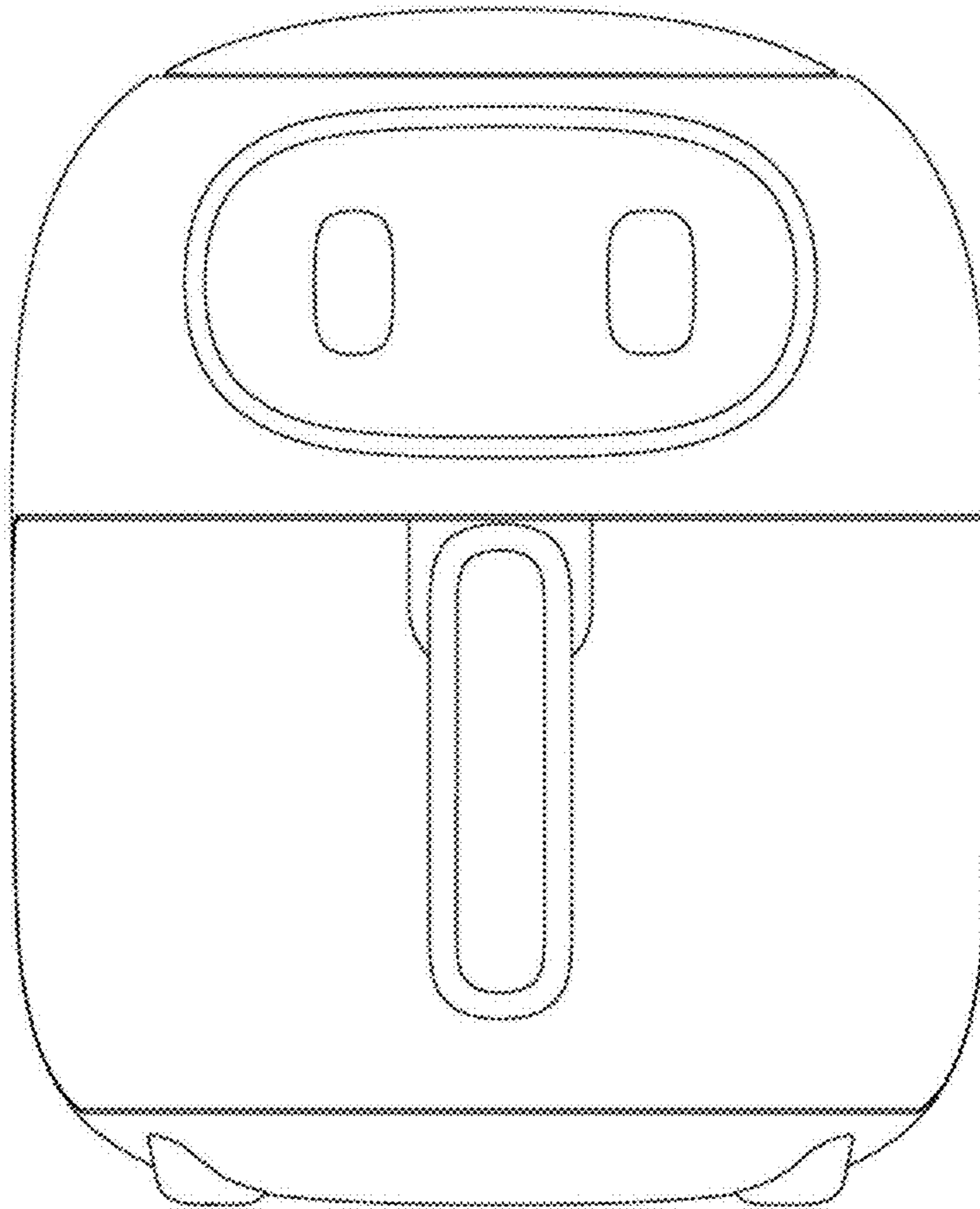

1.2

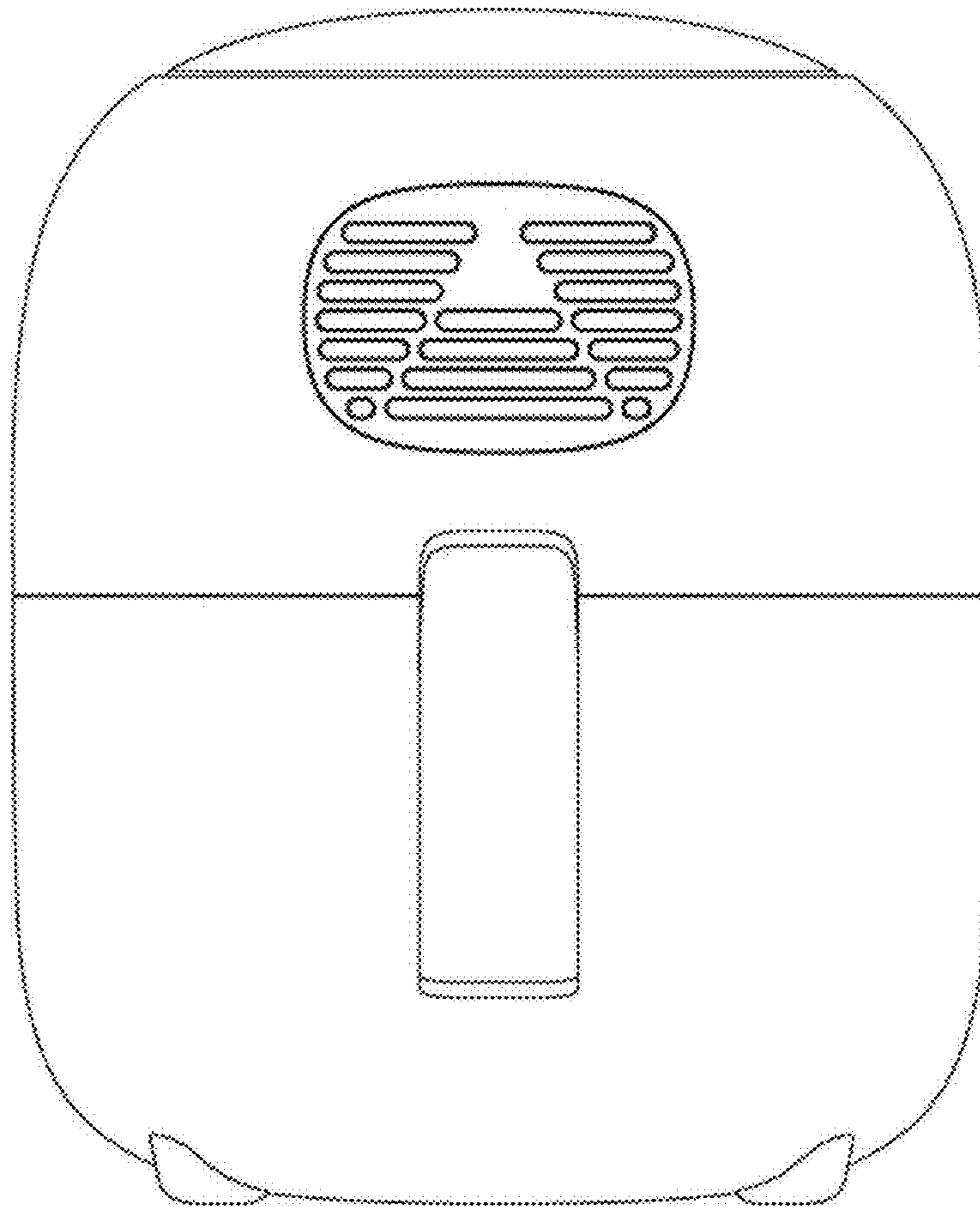

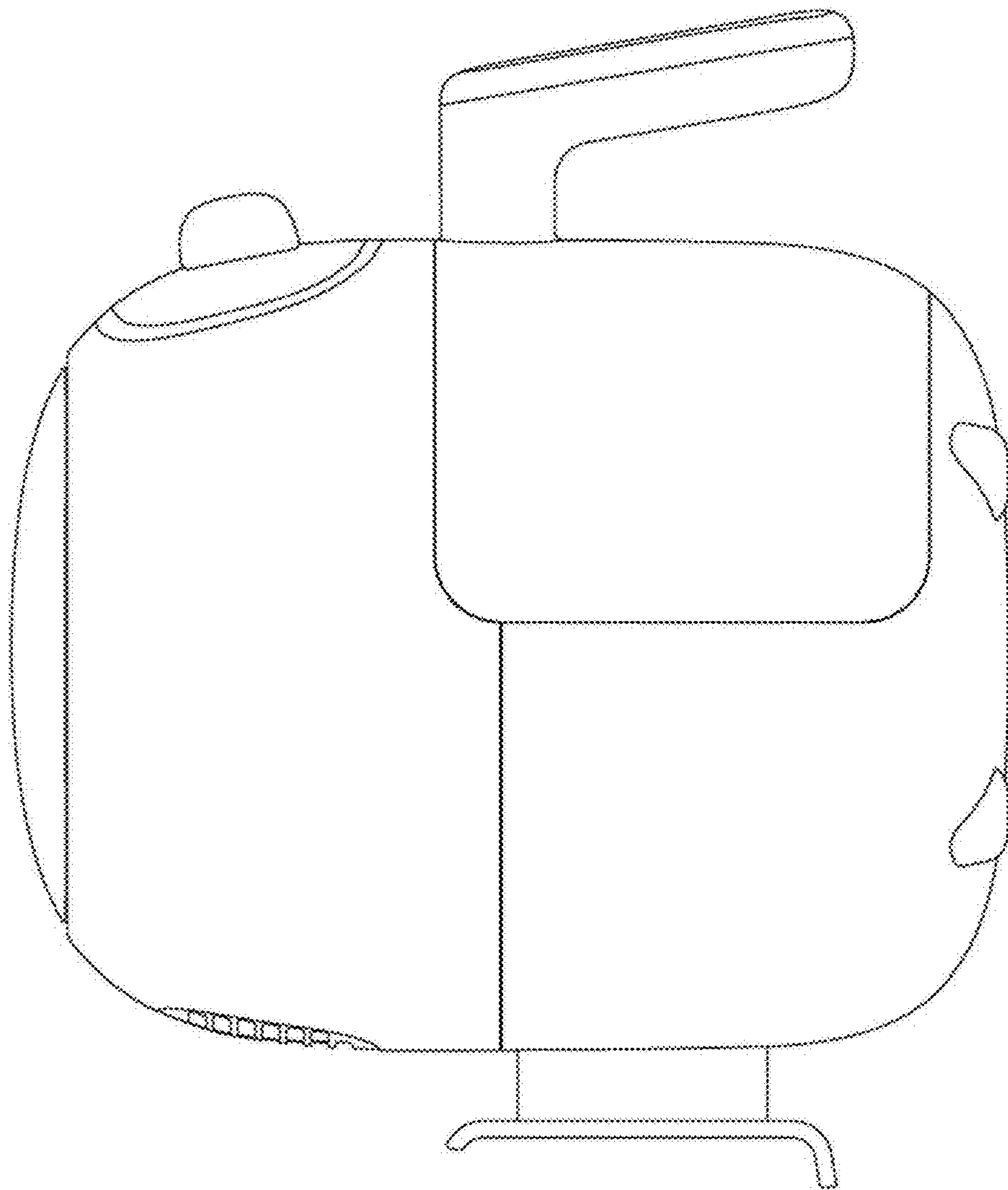

1.3

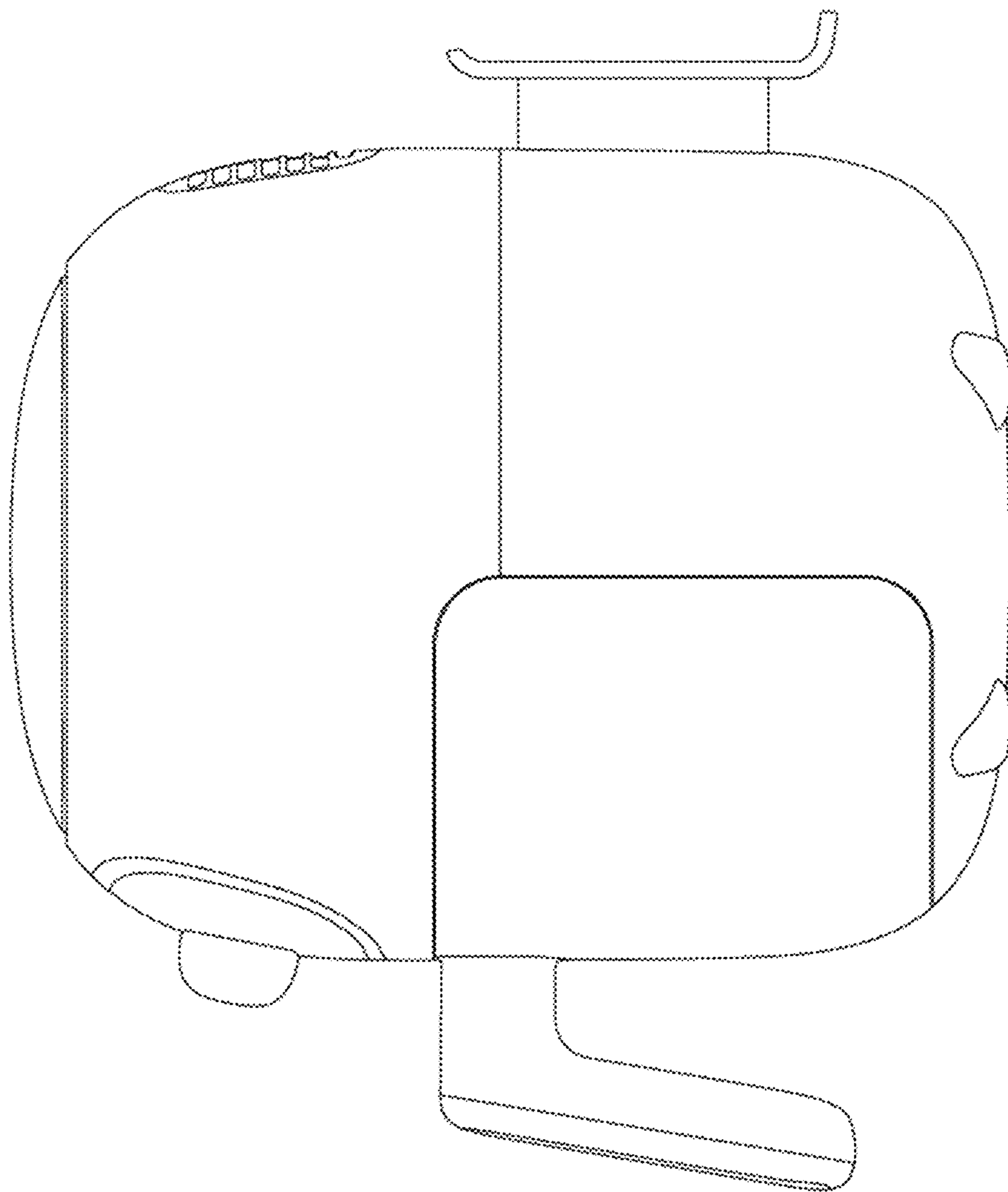

1.4

1.5

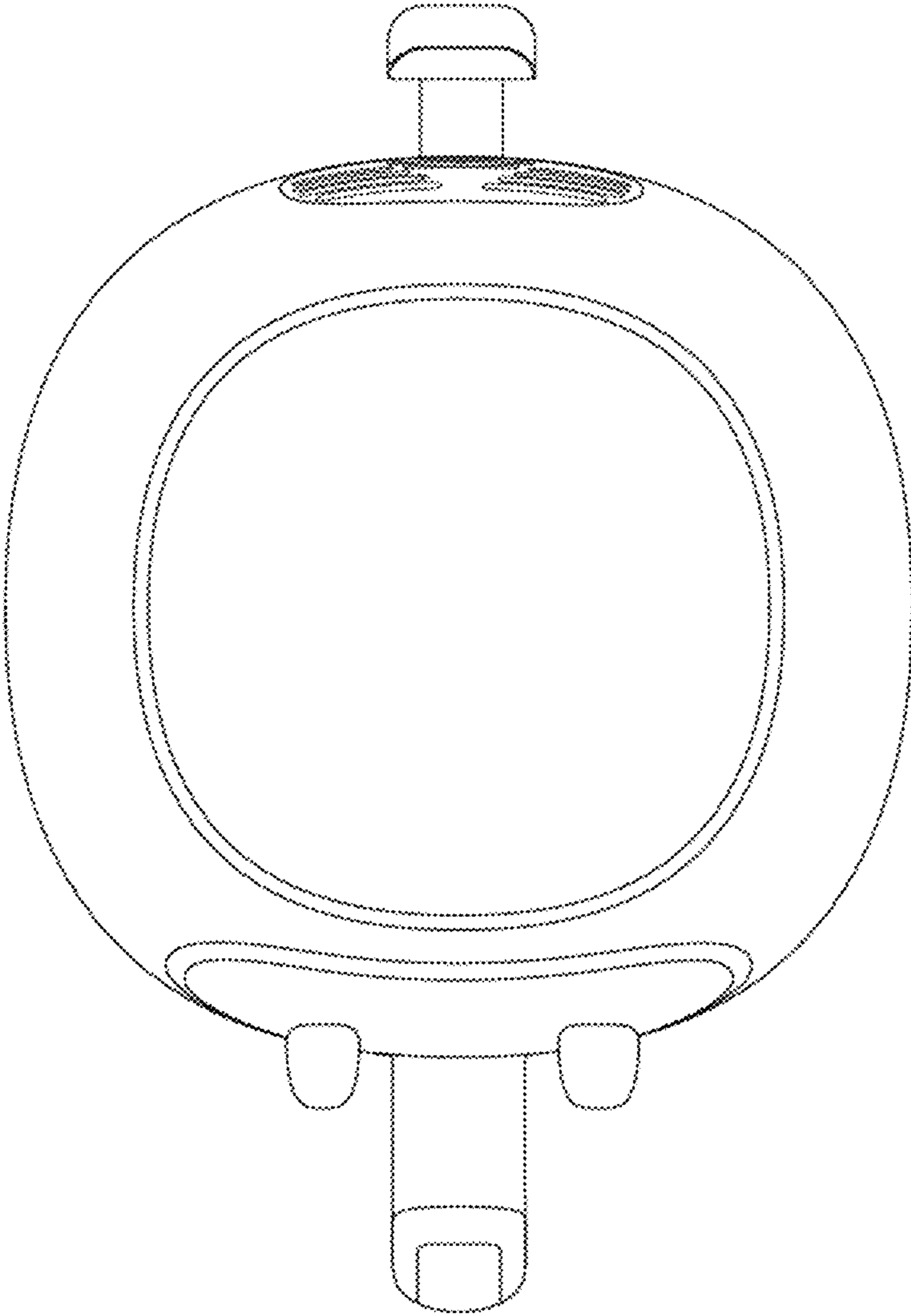

1.6

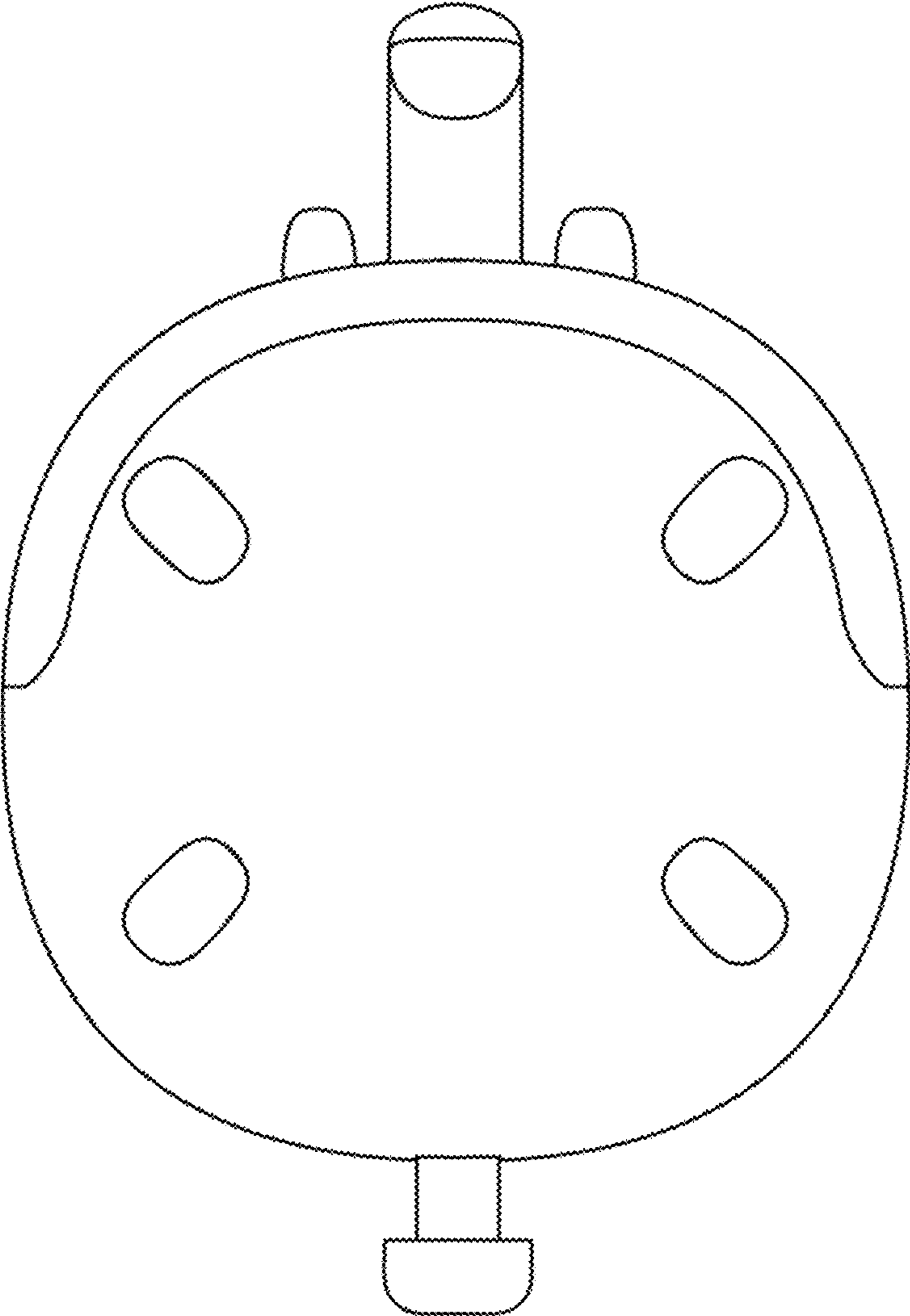

1.7

