



US00D953089S

(12) **United States Design Patent**  
**Scheinert**

(10) **Patent No.:** **US D953,089 S**

(45) **Date of Patent:** **\*\* May 31, 2022**

(54) **DRINKING VESSEL IN THE FORM OF A SYRINGE**

(71) Applicant: **Dennis Scheinert**, Seitingen-Oberflacht (DE)

(72) Inventor: **Dennis Scheinert**, Seitingen-Oberflacht (DE)

(\*\*) Term: **15 Years**

(21) Appl. No.: **35/511,790**

(22) Filed: **Mar. 31, 2021**

(80) **Hague Agreement Data**

Int. Filing Date: **Mar. 31, 2021**

Int. Reg. No.: **DM/213971**

Int. Reg. Date: **Mar. 31, 2021**

Int. Reg. Pub. Date: **May 7, 2021**

(51) **LOC (13) Cl.** ..... **07-01**

(52) **U.S. Cl.**  
USPC ..... **D7/319; D24/114**

(58) **Field of Classification Search**  
USPC ..... D7/300, 319, 376, 373, 379, 384, 392.1,  
D7/397, 400, 511, 515; D24/114

CPC ..... A61J 1/2055  
See application file for complete search history.

(56) **References Cited**

**U.S. PATENT DOCUMENTS**

D262,739 S \* 1/1982 Nitshke ..... D24/114  
D274,838 S \* 7/1984 Shadwell ..... D24/114  
4,612,010 A \* 9/1986 Hamacher ..... A61M 5/315  
604/218  
D294,640 S \* 3/1988 Wicken ..... D24/114  
D323,031 S \* 1/1992 Ahstrand ..... D24/114

D323,391 S \* 1/1992 Payne ..... D24/112  
D328,643 S \* 8/1992 Mitchell ..... D24/114  
D445,176 S \* 7/2001 Landers ..... D24/114  
D552,773 S \* 10/2007 Greenberg ..... D26/37  
D560,969 S \* 2/2008 Mansfield ..... D7/509  
D563,171 S \* 3/2008 Mansfield ..... D7/509  
D809,867 S \* 2/2018 Leigh ..... D7/523

\* cited by examiner

*Primary Examiner* — S. Bryan Reinholdt, Jr.

(57) **CLAIM**

The ornamental design for a drinking vessel in the form of a syringe, as shown and described.

**DESCRIPTION**

- 1. Drinking vessel in the form of a syringe
- 2. Drinking vessel in the form of a syringe
- 1.1 : Perspective
- 1.2 : Front
- 1.3 : Right
- 1.4 : Top
- 1.5 : Perspective
- 1.6 : Front
- 1.7 : Right
- 1.8 : Perspective
- 2.1 : Perspective
- 2.2 : Front
- 2.3 : Right
- 2.4 : Top
- 2.5 : Perspective
- 2.6 : Front
- 2.7 : Right

A syringe-type cylindrical container for drinks that has a plunger that fits tightly in a barrel.

**1 Claim, 15 Drawing Sheets**

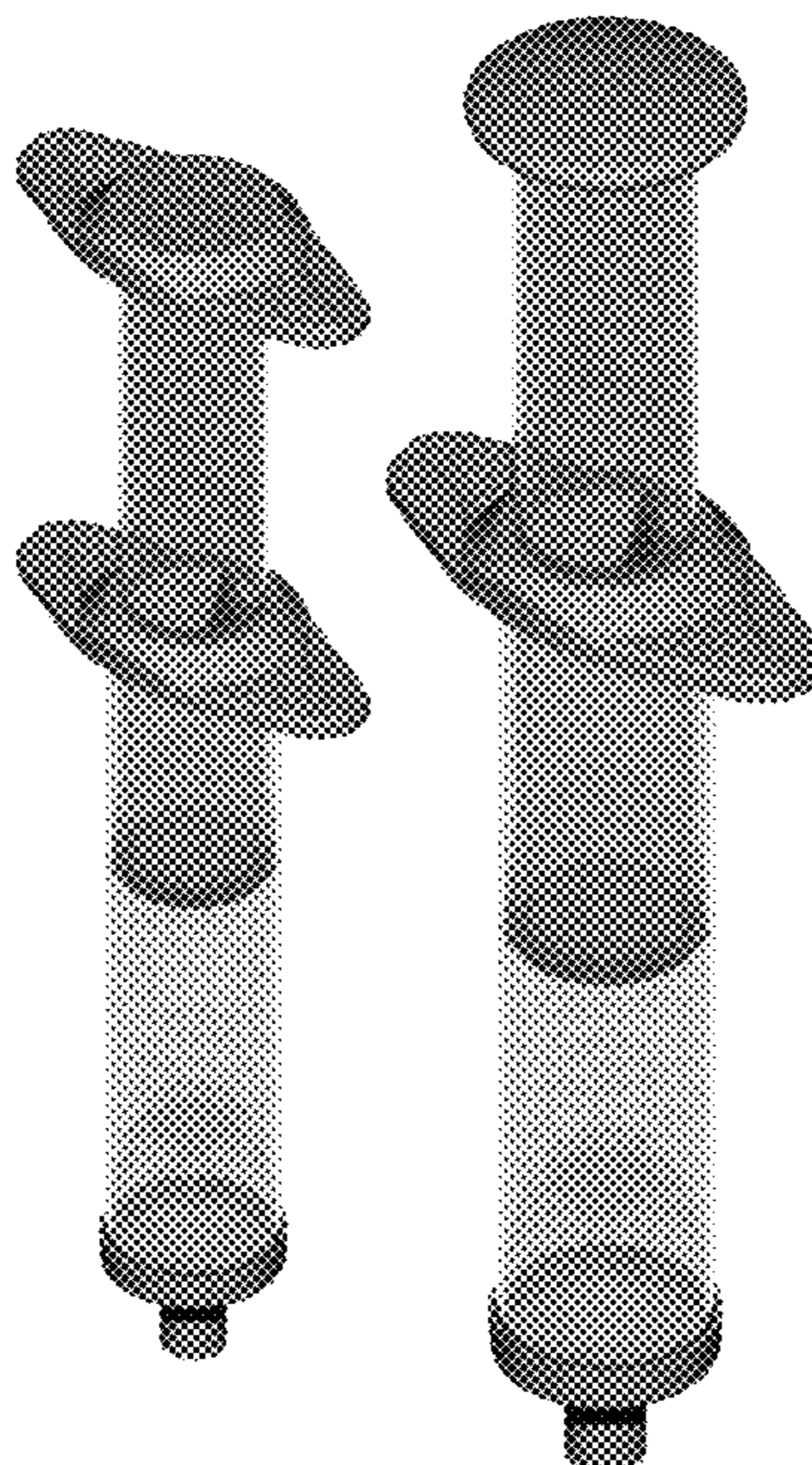

**1.1**

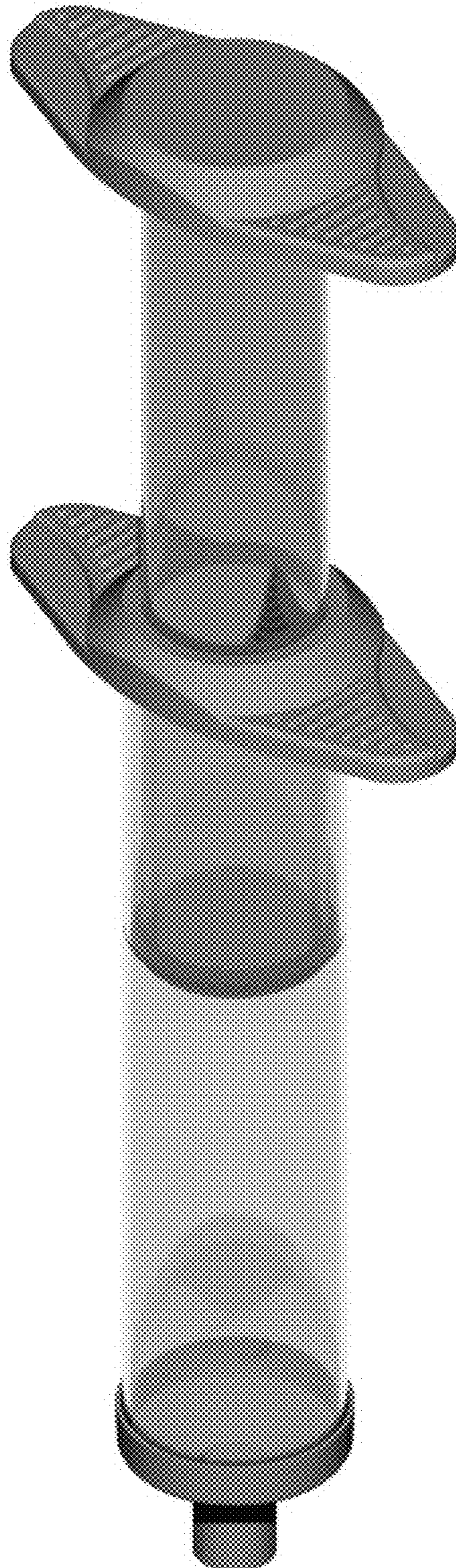

1.2

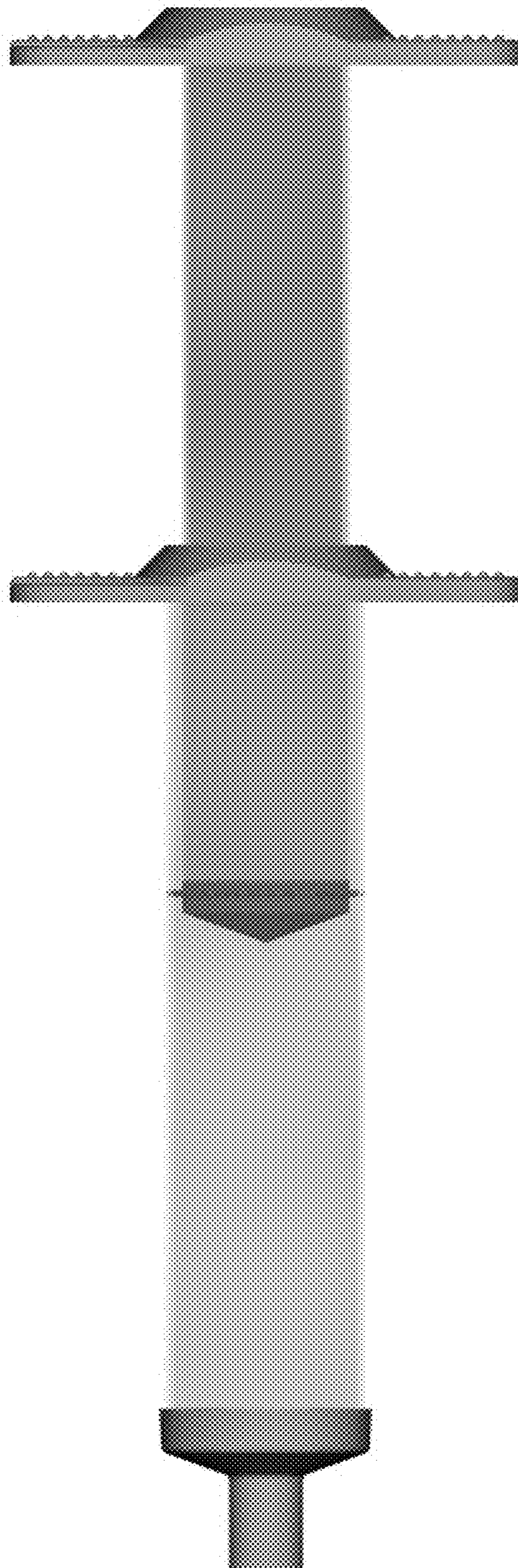

1.3

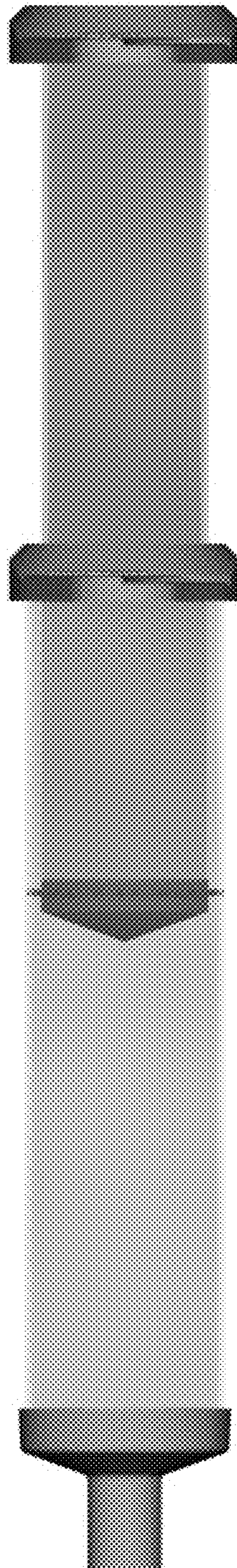

1.4

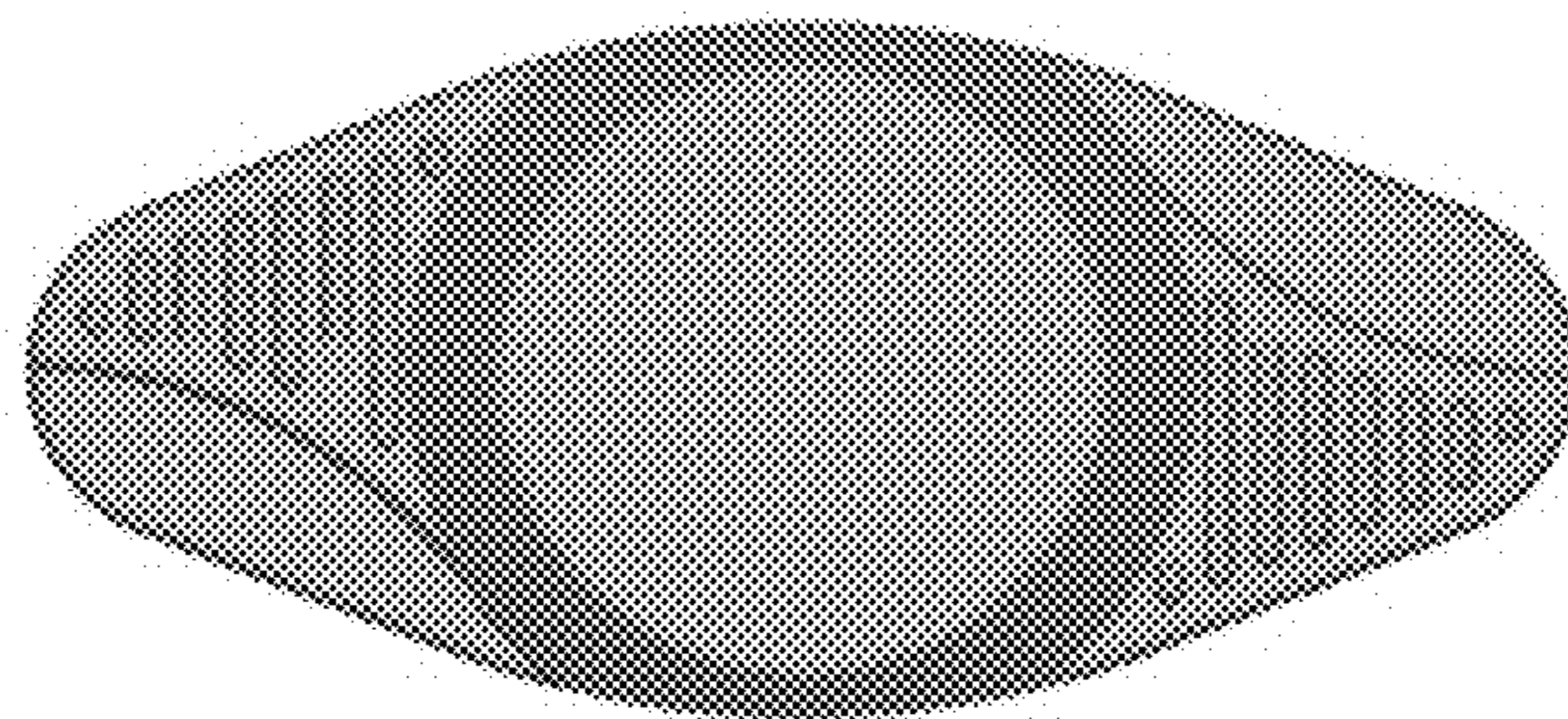

**1.5**

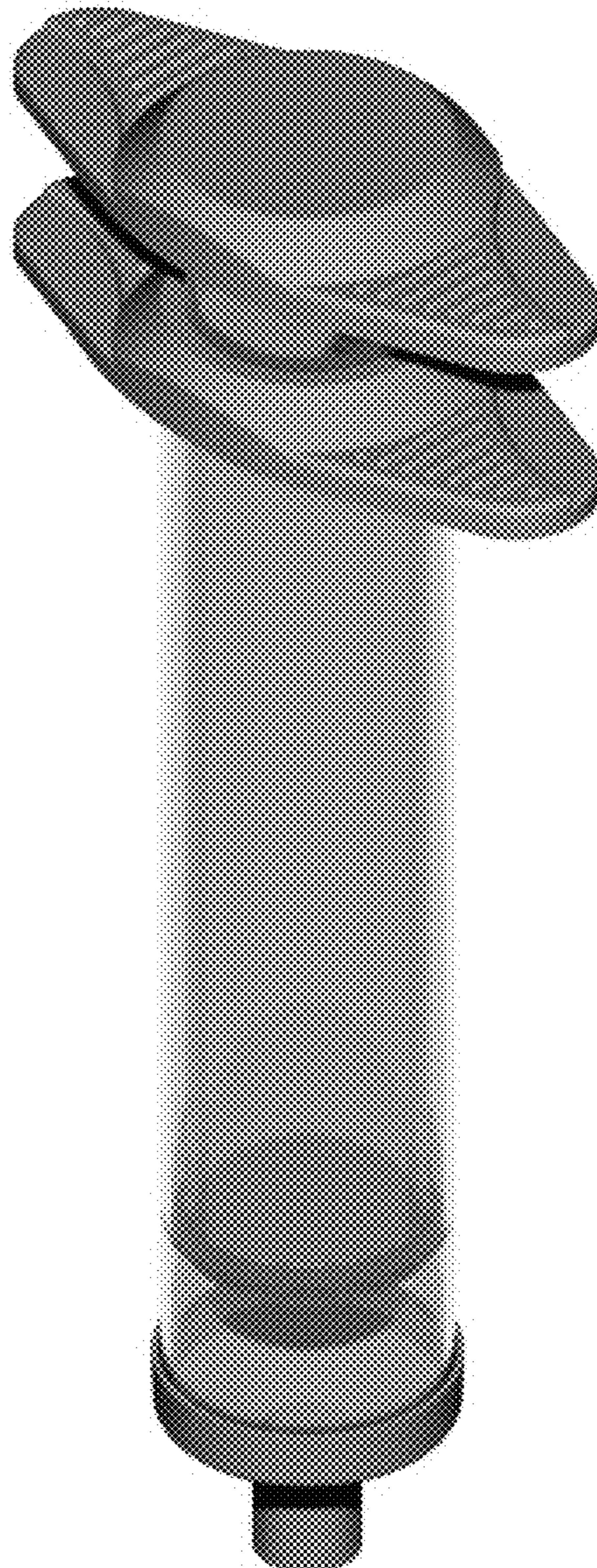

1.6

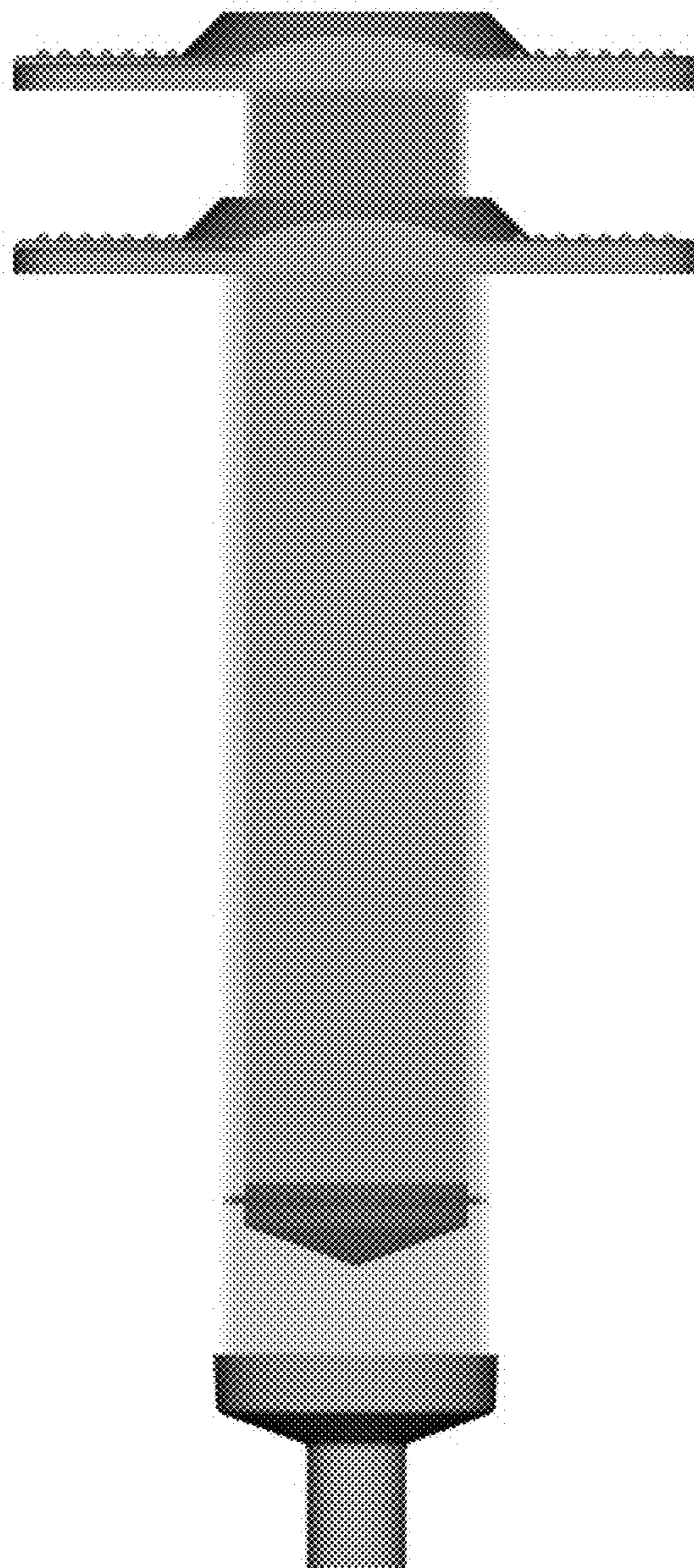

1.7

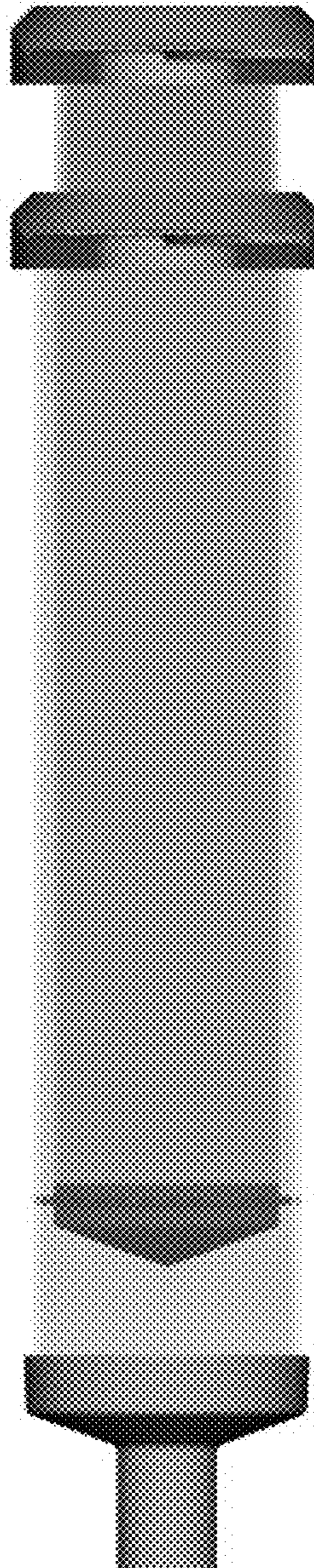



1.8

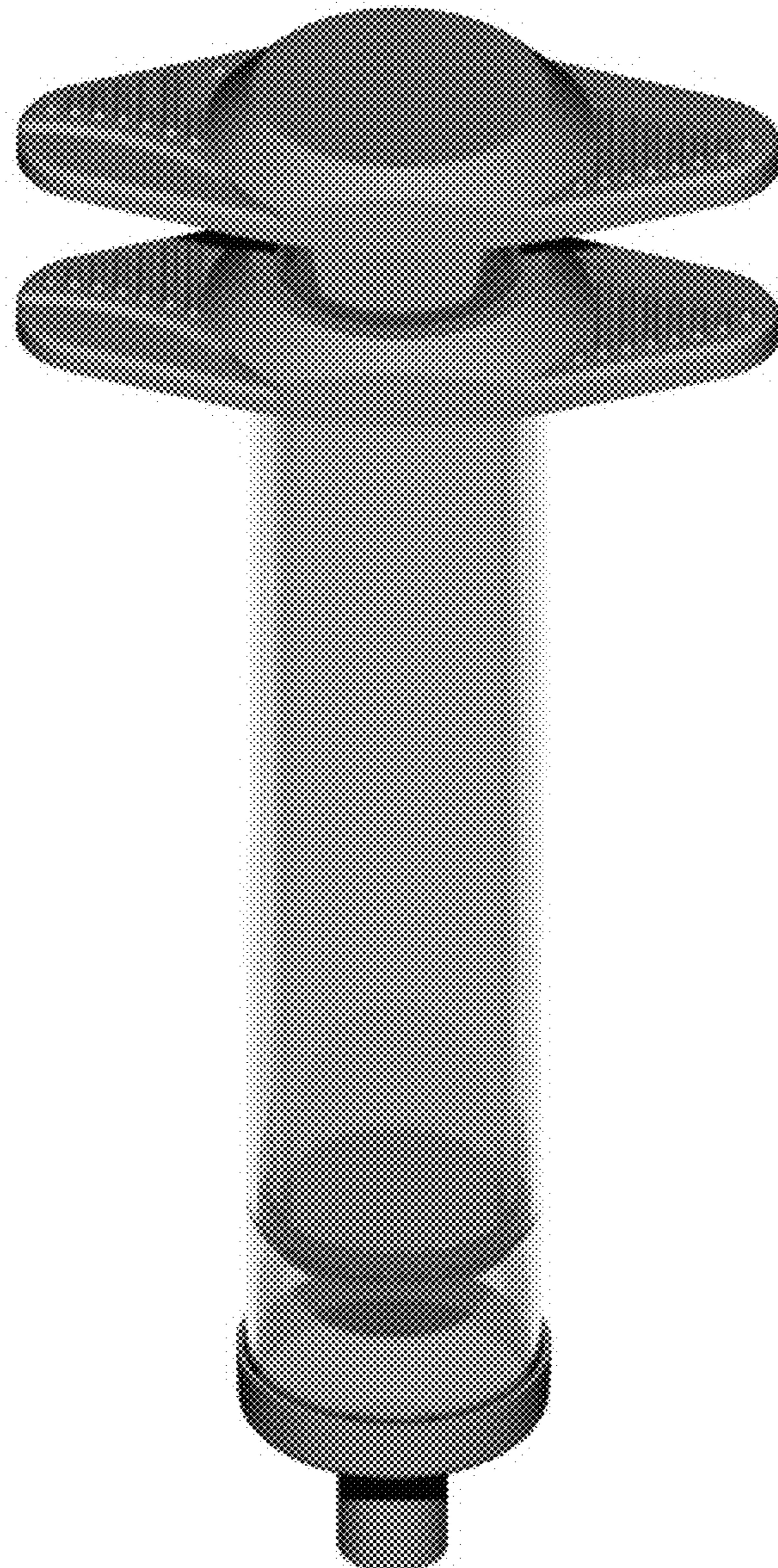

# 2.1

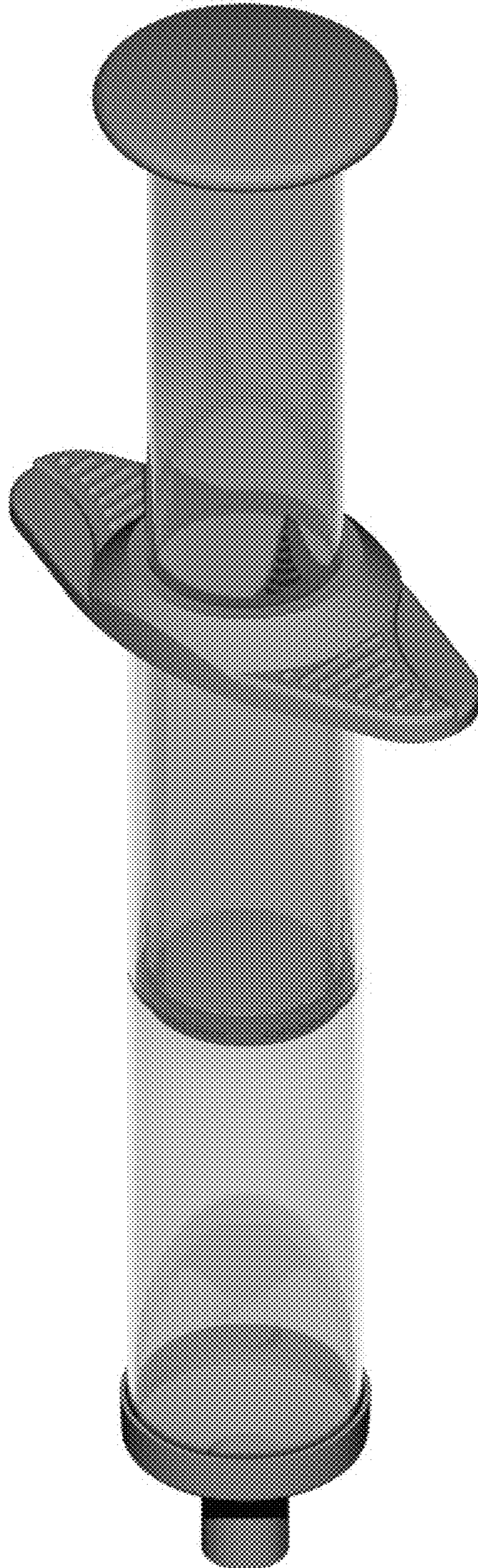

2.2

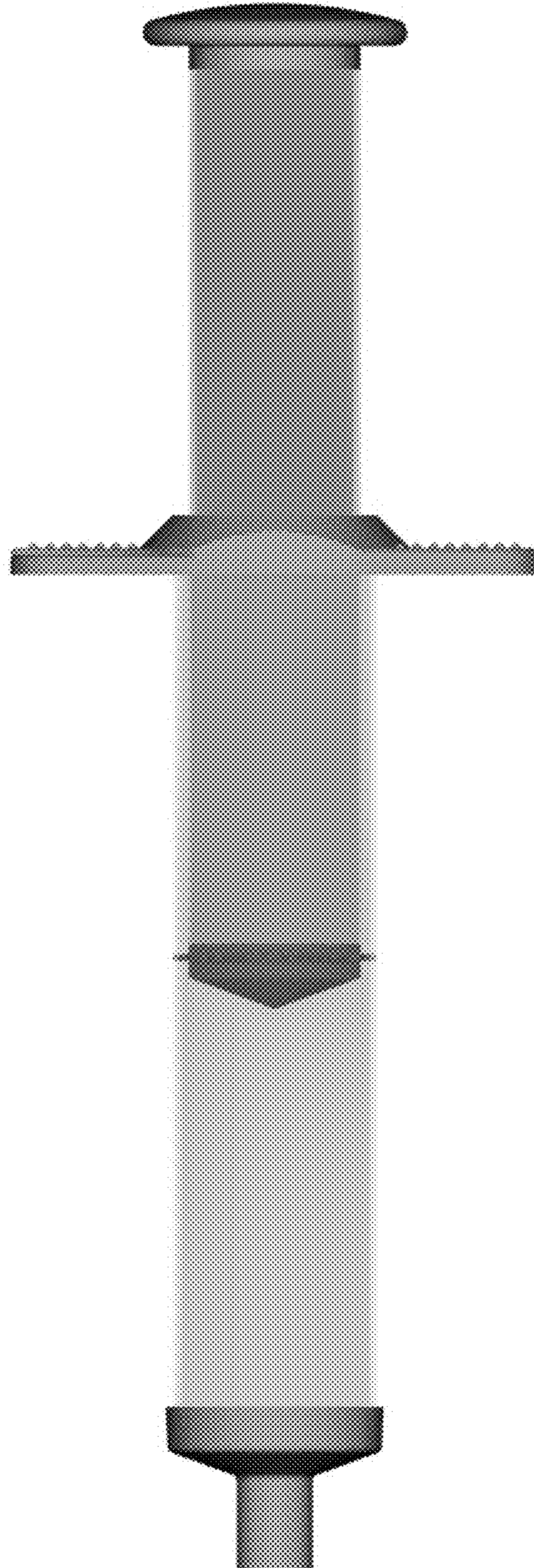

# 2.3

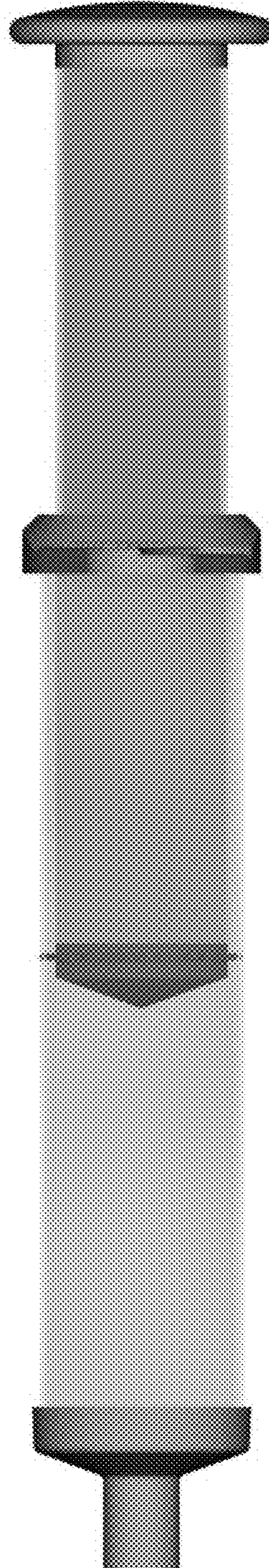

**2.4**



2.5

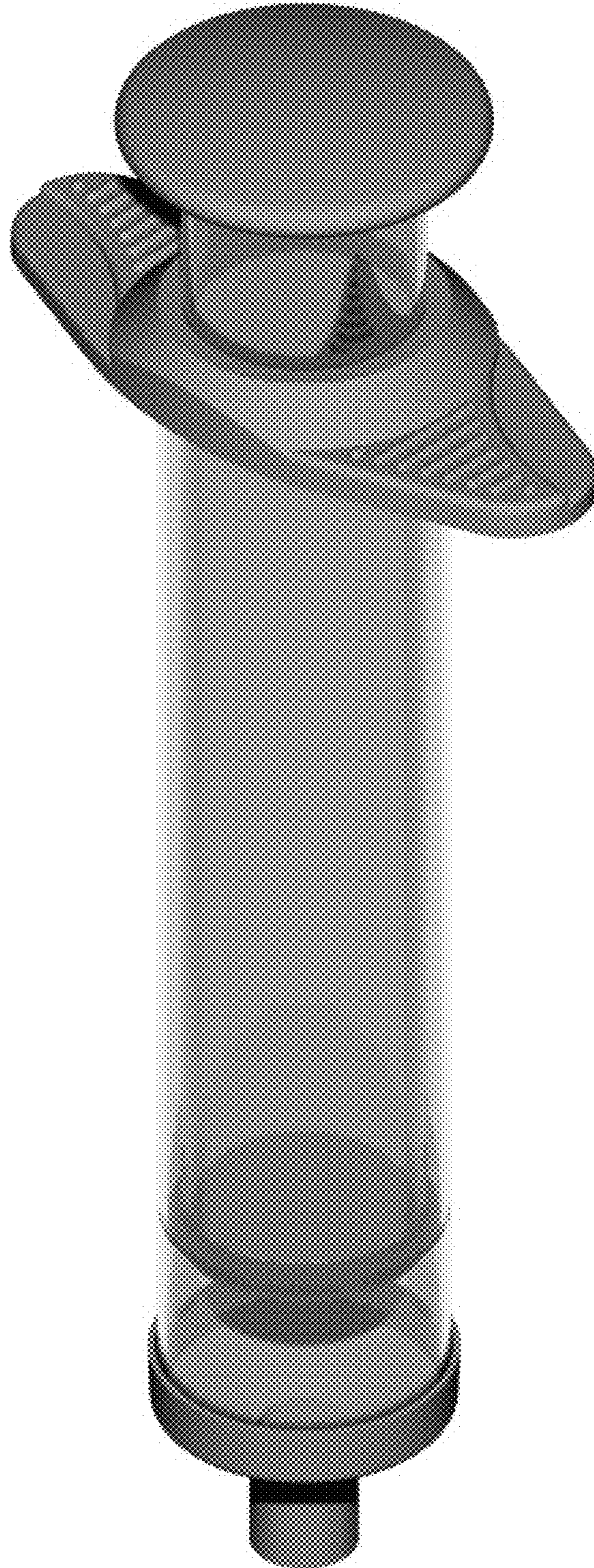

# 2.6

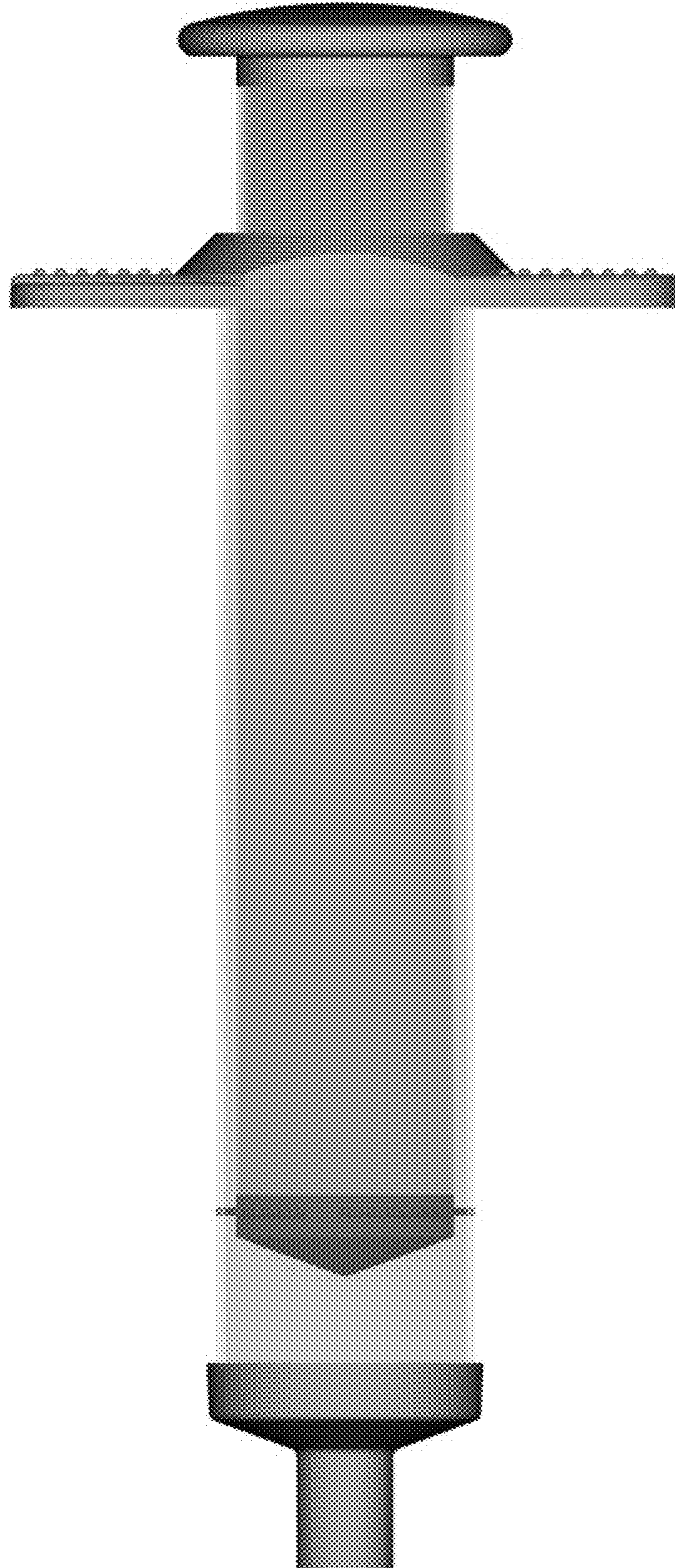

2.7

