



US00D953056S

(12) **United States Design Patent**  
**Altherr et al.**

(10) **Patent No.:** **US D953,056 S**  
(45) **Date of Patent:** **\*\* May 31, 2022**

(54) **CHAIR**  
(71) Applicant: **ARPER S.P.A.**, Treviso (IT)  
(72) Inventors: **Jeannette Altherr**, Treviso (IT);  
**Delphine Désile**, Treviso (IT); **Alberto Lievore**, Treviso (IT); **Dennis Park**, Treviso (IT)  
(73) Assignee: **ARPER S.p.A.**, Treviso (IT)  
(\*\*) Term: **15 Years**  
(21) Appl. No.: **35/510,399**  
(22) Filed: **Sep. 4, 2020**  
(80) **Hague Agreement Data**  
Int. Filing Date: **Sep. 4, 2020**  
Int. Reg. No.: **DM/210327**  
Int. Reg. Date: **Sep. 4, 2020**  
Int. Reg. Pub. Date: **Sep. 25, 2020**

(30) **Foreign Application Priority Data**  
Mar. 9, 2020 (WO) ..... 92881  
(51) **LOC (13) Cl.** ..... **06-01**  
(52) **U.S. Cl.**  
USPC ..... **D6/375; D6/373**  
(58) **Field of Classification Search**  
USPC ..... D6/334, 335, 360, 371–376, 381  
CPC .. A47C 3/00; A47C 3/026; A47C 3/04; A47C 3/012; A47C 5/00; A47C 5/12; A47C 13/00; A47C 13/002; A47C 13/004; A47C 13/02; A47C 13/029; A47C 13/16; A47C 13/36; A47C 13/38; A47C 13/40; A47C 13/54  
See application file for complete search history.

(56) **References Cited**  
U.S. PATENT DOCUMENTS  
2,649,901 A \* 8/1953 Johnson ..... A47C 3/12  
297/411.42  
2,723,712 A \* 11/1955 Yellen ..... A47C 3/12  
297/440.11

2,733,755 A \* 2/1956 Boucher ..... A47C 4/18  
297/411.41  
D183,743 S \* 10/1958 Howell, Jr. .... D6/334  
3,030,148 A \* 4/1962 Howell, Jr. .... A47C 3/12  
297/452.6  
D730,074 S \* 5/2015 Lievore ..... A47C 4/30  
D6/373  
10,159,349 B1 \* 12/2018 Frankel ..... A47C 4/30  
D886,485 S \* 6/2020 Li ..... A47C 4/02  
D6/375  
D906,701 S \* 1/2021 Li ..... D6/334  
D923,380 S \* 6/2021 Welling ..... D6/716  
D924,595 S \* 7/2021 Li ..... D6/373  
D927,873 S \* 8/2021 Akkad ..... A47C 3/12  
D6/368  
2018/0098632 A1 \* 4/2018 Frankel ..... A47C 4/02

**OTHER PUBLICATIONS**

Adell Sled Base Lounge Chair, by Arper—Eporta <https://www.eporta.com/item/194646/arper/adell-sled-base-lounge-chair/> retrieved from the internet on Aug. 24, 2021.\*

\* cited by examiner

*Primary Examiner* — Mary Ann Calabrese  
(74) *Attorney, Agent, or Firm* — Thomas | Horstemeyer, LLP

(57) **CLAIM**

The ornamental design for a chair, as shown and described.

**DESCRIPTION**

1.1 is a front perspective view of a chair, showing our new design;  
1.2 is a front view;  
1.3 is a rear view;  
1.4 is a side view;  
1.5 is side view, from a side opposite that of 1.4;  
1.6 is a top view; and  
1.7 is a bottom view.

**1 Claim, 7 Drawing Sheets**

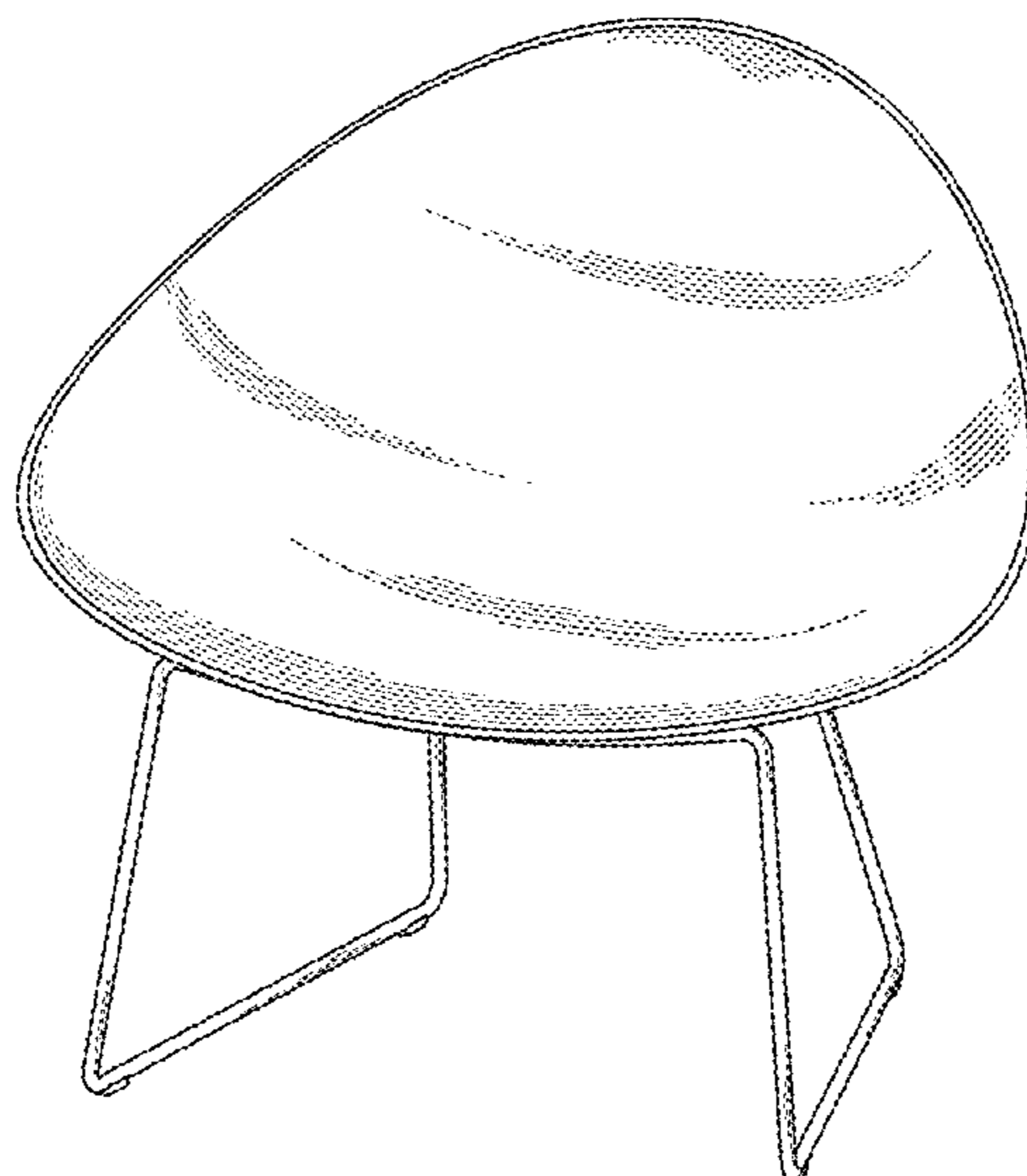

1.1

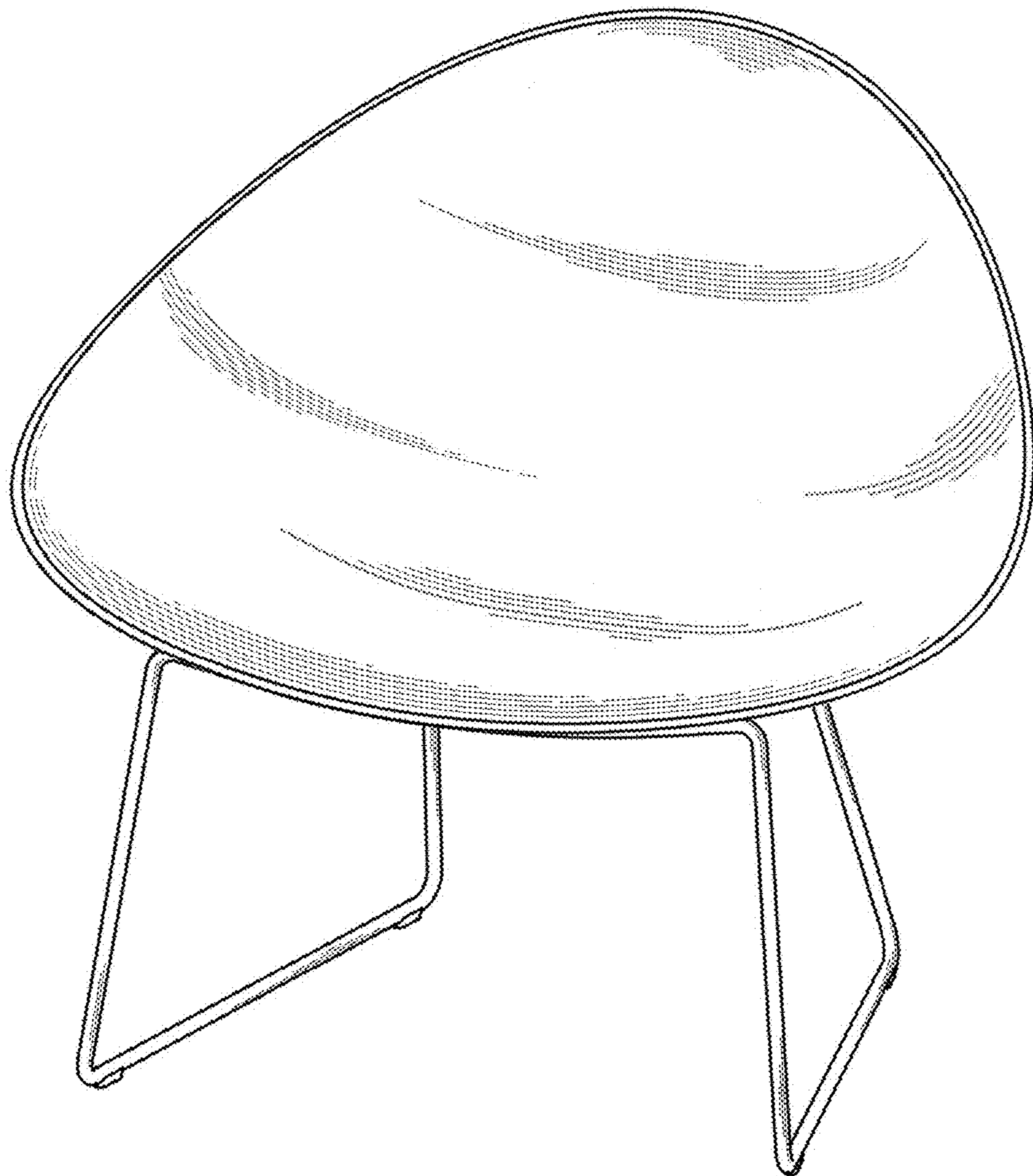

1.2

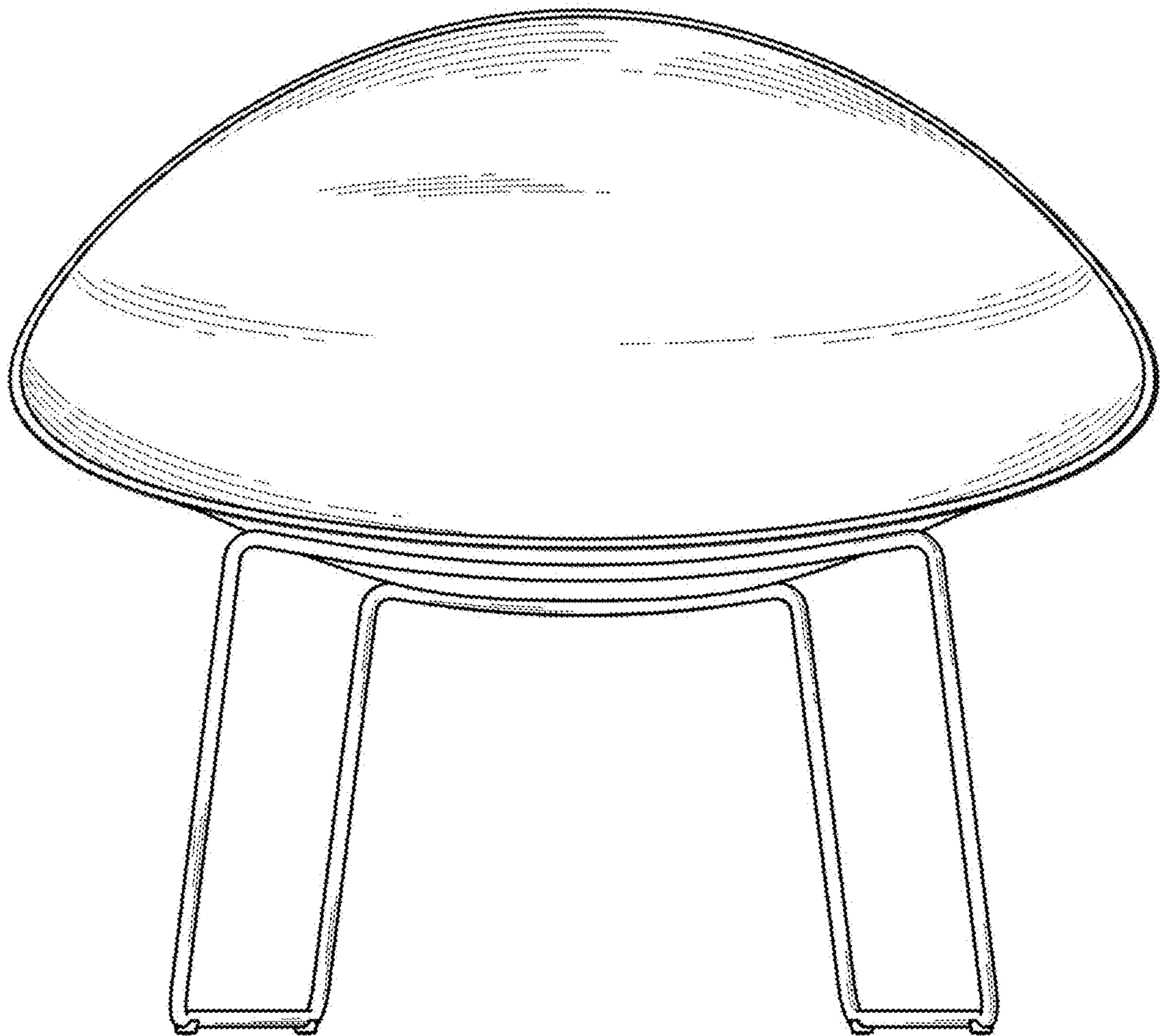

1.3

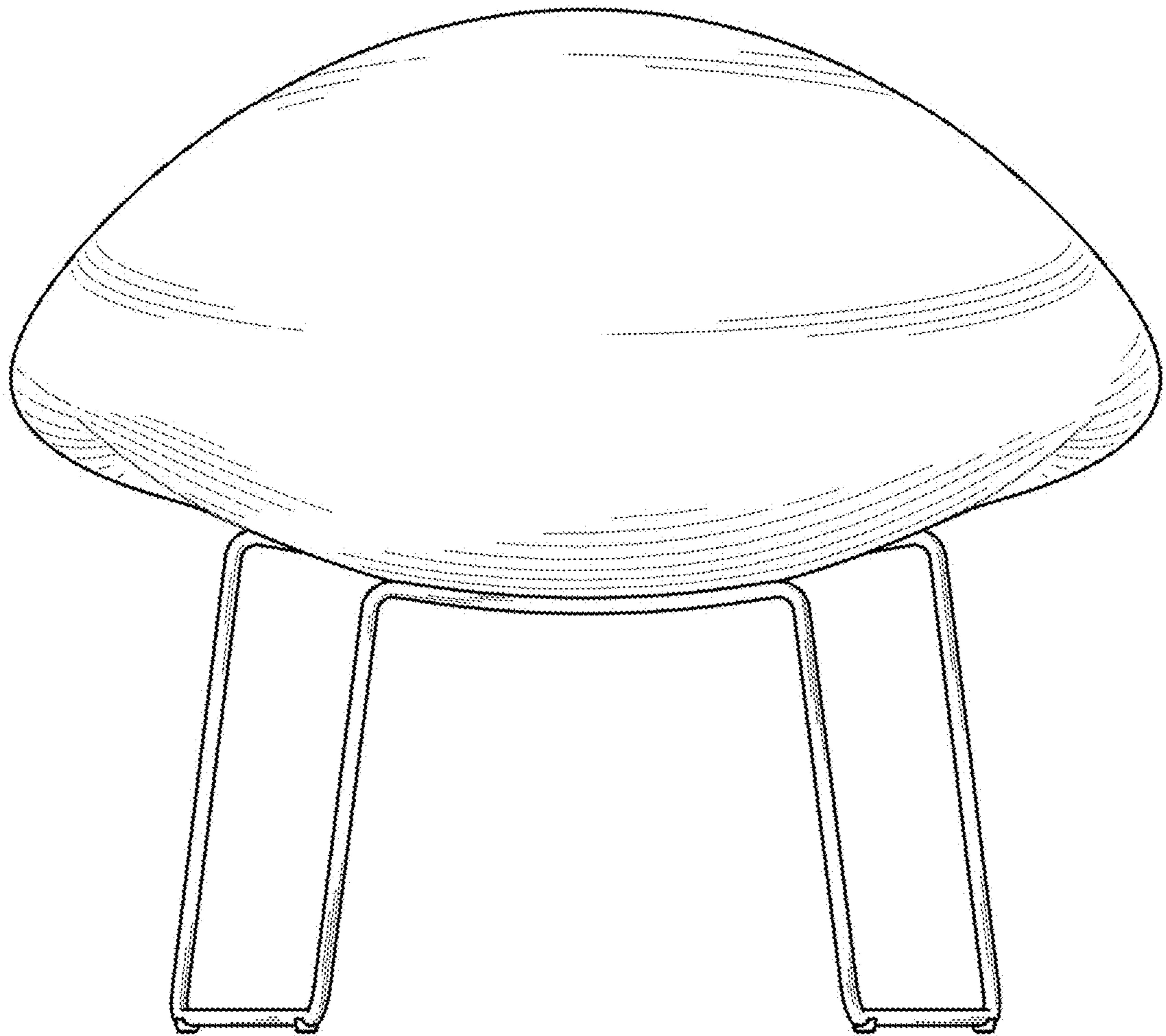



1.4

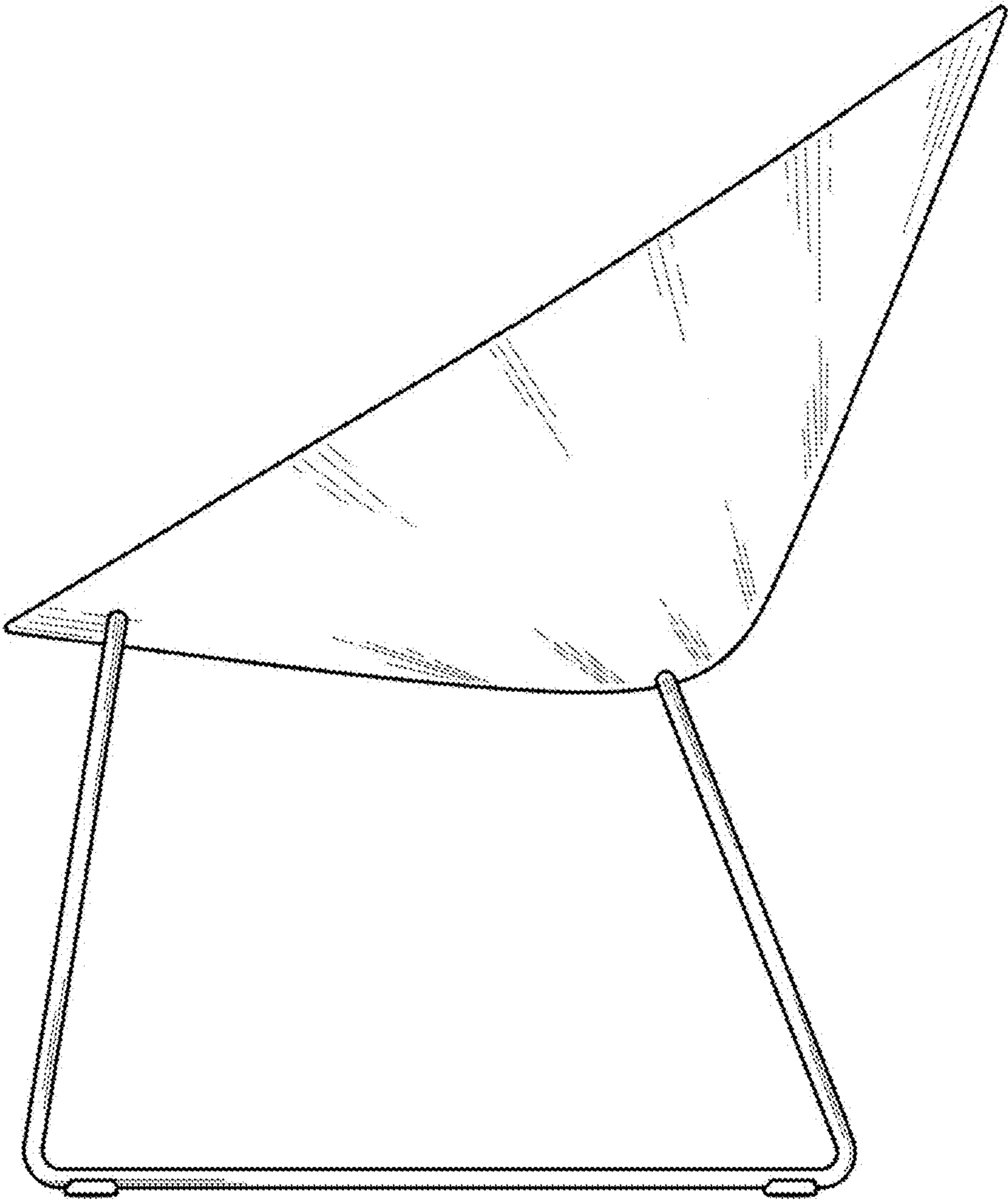

1.5

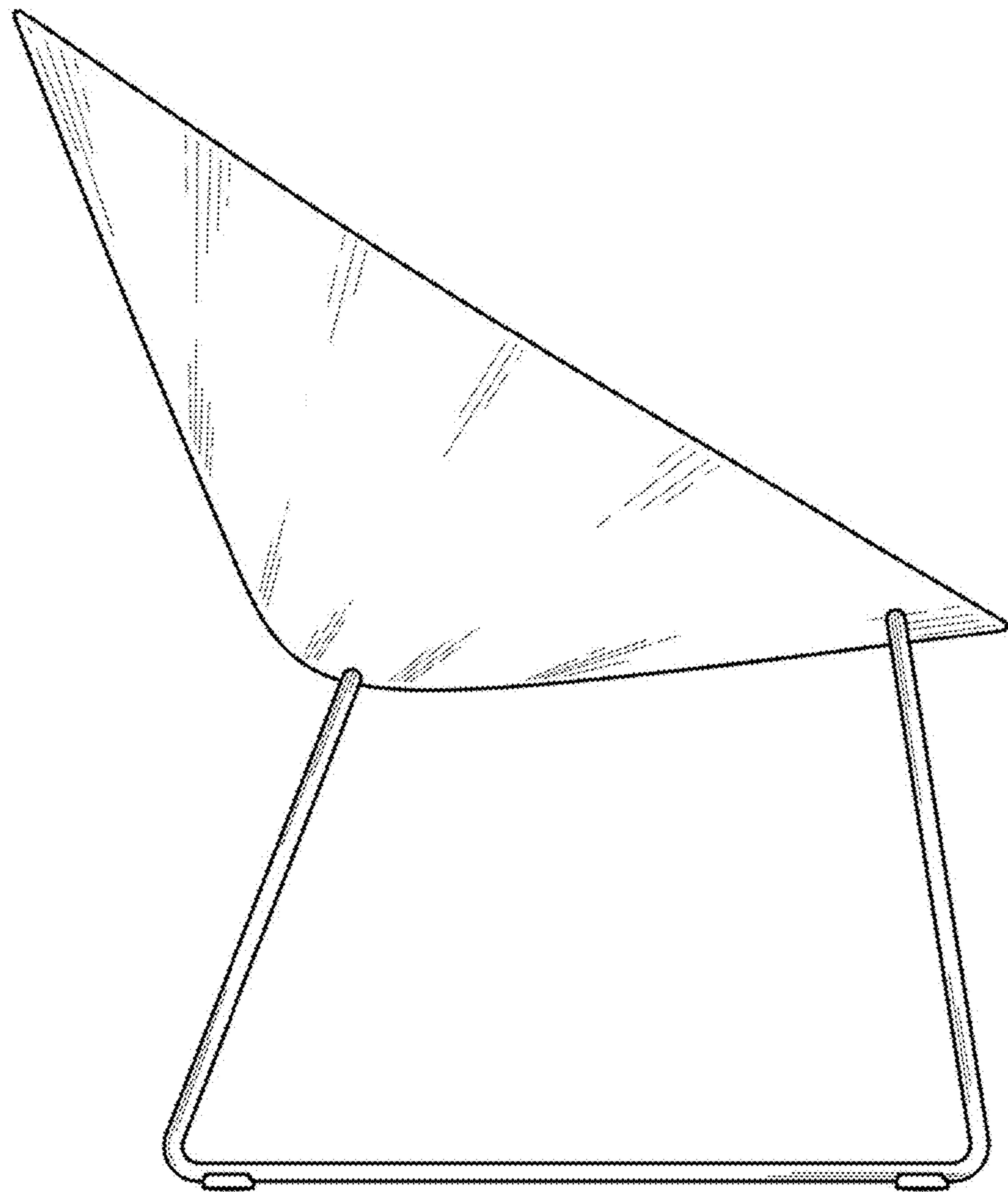

1.6

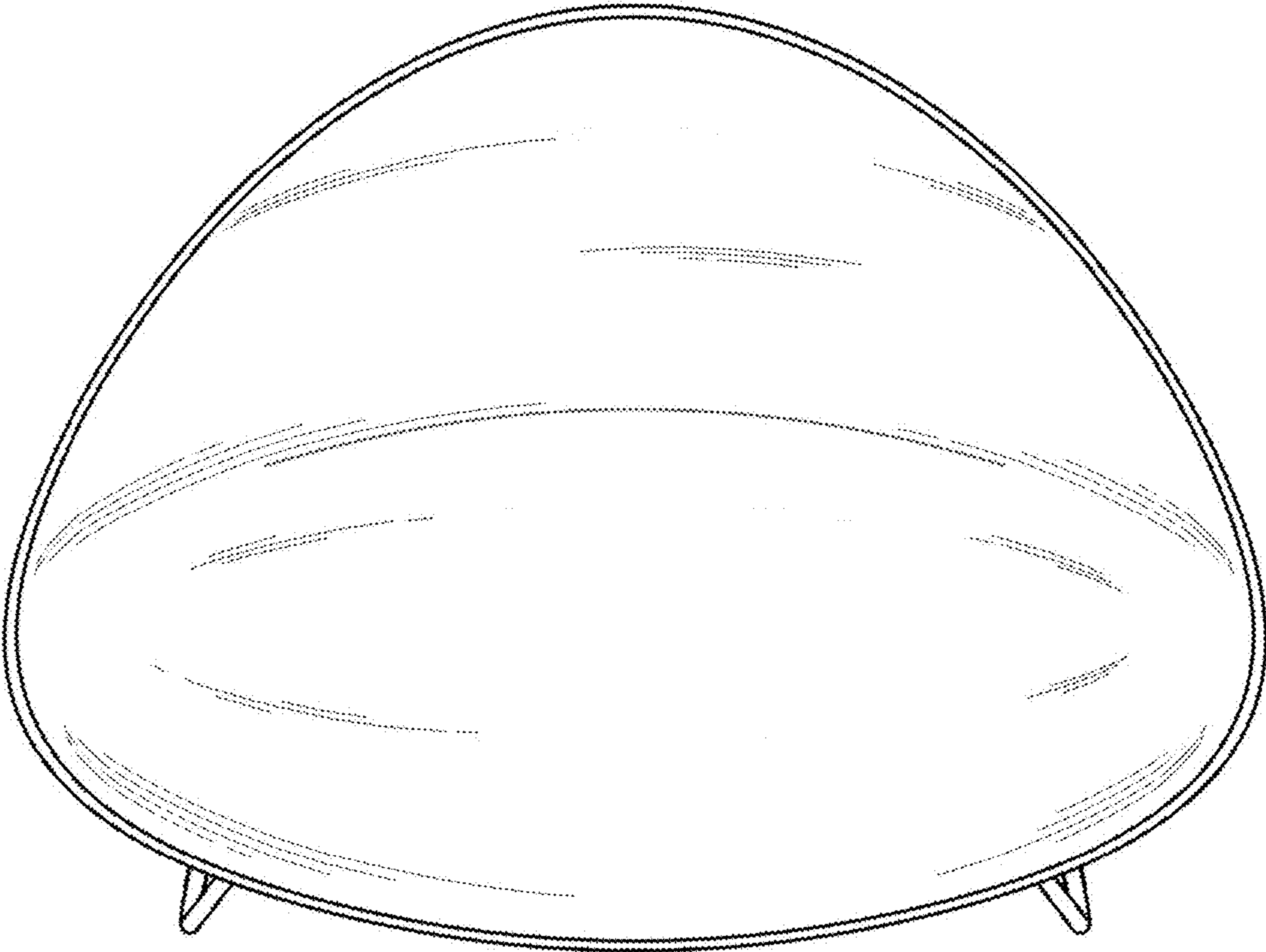

1.7

