



US00D953039S

(12) **United States Design Patent**  
**Altmann et al.**

(10) **Patent No.:** **US D953,039 S**  
(45) **Date of Patent:** **\*\* May 31, 2022**

(54) **TOOTHBRUSH HEAD**

FOREIGN PATENT DOCUMENTS

(71) Applicant: **Braun GmbH**, Kronberg (DE)  
(72) Inventors: **Niclas Altmann**, Schoeneck (DE);  
**Anke Renz**, Schwalbach (DE); **Bianka  
Becker-Salzsäuler**, Liederbach (DE);  
**Heidrun Schmelcher**, Kronberg (DE);  
**Fritz Schubert**, Bad Camberg (DE);  
**Ulrich Stoerkel**, Bad Nauheim (DE)

CN 304108476 4/2017  
KR 3008785860000 10/2016  
WO DM093822 5/2017

(73) Assignee: **Braun GmbH**, Kronberg (DE)

(\*\*) Term: **15 Years**

(21) Appl. No.: **29/758,442**

(22) Filed: **Nov. 16, 2020**

**Related U.S. Application Data**

(60) Continuation of application No. 29/754,305, filed on  
Oct. 9, 2020, which is a division of application No.  
(Continued)

(30) **Foreign Application Priority Data**

Oct. 14, 2015 (WO) ..... 927982601

(51) **LOC (13) Cl.** ..... **04-02**

(52) **U.S. Cl.**  
USPC ..... **D4/101**

(58) **Field of Classification Search**  
USPC ..... D4/100, 101, 104, 105-112, 116, 119,  
D4/121, 127, 129, 130, 136, 137, 138;  
(Continued)

(56) **References Cited**

U.S. PATENT DOCUMENTS

D483,183 S \* 12/2003 De Salvo ..... D4/101  
D487,636 S \* 3/2004 De Salvo ..... D4/101  
(Continued)

OTHER PUBLICATIONS

All Office Actions, U.S. Appl. No. 29/654,969.  
(Continued)

*Primary Examiner* — Michael C Stout  
*Assistant Examiner* — Katrina N Gonzalez  
(74) *Attorney, Agent, or Firm* — Vladimir Vitenberg

(57) **CLAIM**

The ornamental design for a toothbrush head, as shown and  
described.

**DESCRIPTION**

FIG. 1 is a perspective view of a first embodiment of a  
toothbrush head;  
FIG. 2 is a front view thereof;  
FIG. 3 is a right side view thereof;  
FIG. 4 is a rear view thereof;  
FIG. 5 is a left side view thereof;  
FIG. 6 is a top plan view thereof;  
FIG. 7 is a bottom view thereof.  
FIG. 8 is a perspective view of a second embodiment of a  
toothbrush head;  
FIG. 9 is a front view thereof;  
FIG. 10 is a right side view thereof;  
FIG. 11 is a rear view thereof;  
FIG. 12 is a left side view thereof;  
FIG. 13 is a top plan view thereof; and,  
FIG. 14 is a bottom view thereof.  
The broken lines illustrate portions of the toothbrush head  
that form no part of the claimed design.

**1 Claim, 8 Drawing Sheets**

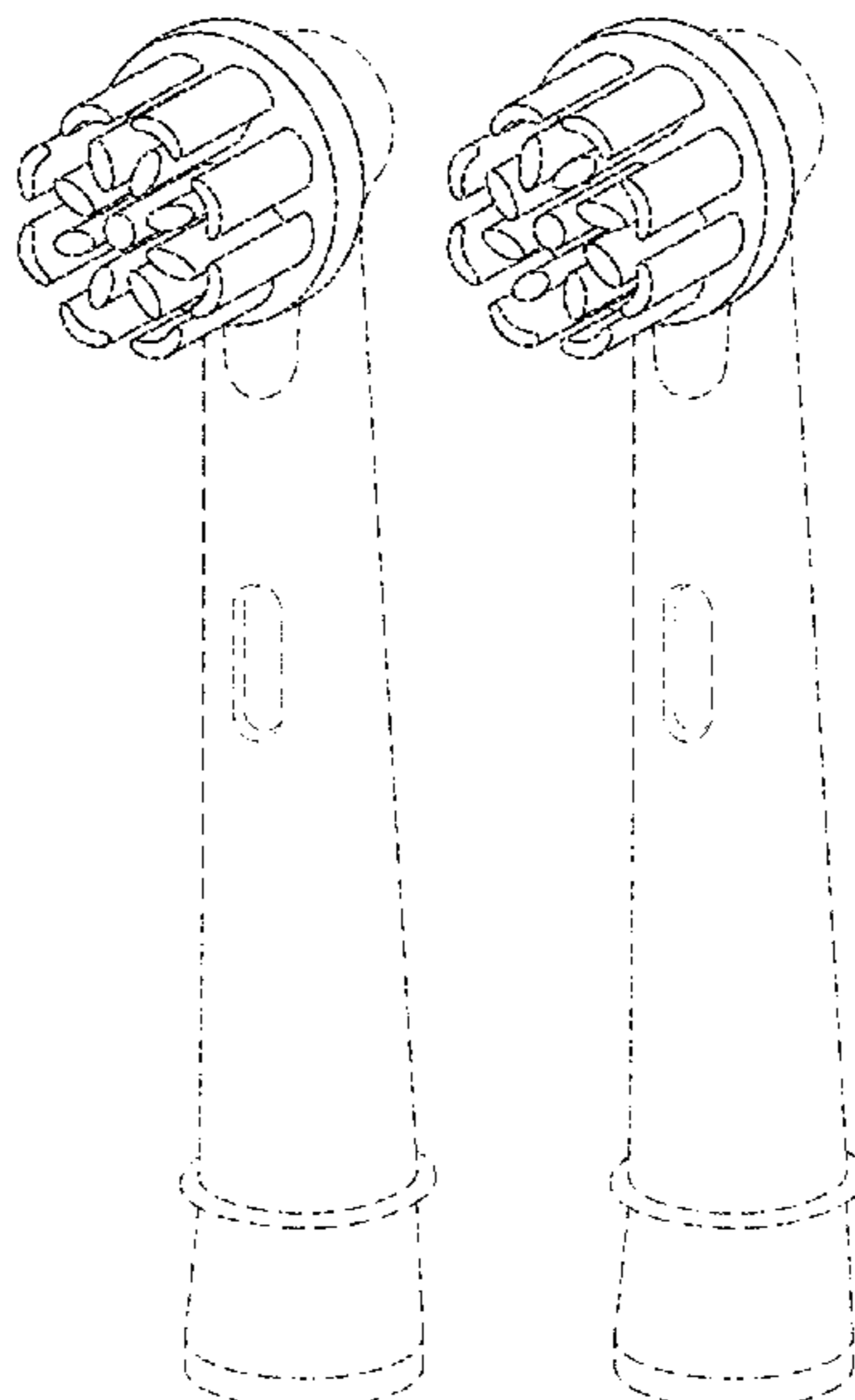

**Related U.S. Application Data**

29/654,969, filed on Jun. 28, 2018, now Pat. No. Des. 902,600, which is a division of application No. 29/561,313, filed on Apr. 14, 2016, now Pat. No. Des. 824,174.

(58) **Field of Classification Search**

USPC ..... D24/133, 152; D28/21, 33, 58, 59; D30/138, 139

CPC ..... A46B 15/0081; A46B 2200/1026; A46B 3/22; A46B 9/005; A46B 9/026; A46B 9/06; A46B 15/0055; A46B 15/0075

See application file for complete search history.

(56) **References Cited**

U.S. PATENT DOCUMENTS

D501,605 S \* 2/2005 Brown, Jr. .... D4/101  
 D509,362 S \* 9/2005 Maeda ..... D4/101  
 D577,199 S \* 9/2008 Zhuan ..... D4/101  
 D579,664 S \* 11/2008 Fisher ..... D4/101  
 D612,611 S \* 3/2010 Brown, Jr. .... D4/101  
 D706,033 S \* 6/2014 Dickie ..... D4/101  
 D824,174 S \* 7/2018 Altmann ..... D4/101  
 D846,881 S \* 4/2019 Altmann ..... D4/101  
 D854,834 S \* 7/2019 Altmann ..... D4/101  
 D863,772 S 10/2019 Hu  
 D863,773 S 10/2019 Hu

D868,476 S \* 12/2019 Papazian ..... D4/101  
 D868,477 S \* 12/2019 Papazian ..... D4/101  
 D868,478 S \* 12/2019 Papazian ..... D4/101  
 D868,479 S \* 12/2019 Papazian ..... D4/101  
 D868,480 S \* 12/2019 Papazian ..... D4/104  
 D868,481 S \* 12/2019 Papazian ..... D4/104  
 D869,852 S \* 12/2019 Papazian ..... D4/101  
 D869,853 S \* 12/2019 Papazian ..... D4/101  
 D869,854 S \* 12/2019 Papazian ..... D4/101  
 D874,156 S \* 2/2020 Altmann ..... D4/127  
 D885,060 S \* 5/2020 Orkin ..... D4/101  
 D902,600 S \* 11/2020 Altmann ..... D4/101  
 D906,679 S \* 1/2021 Yang ..... D4/101  
 D907,368 S \* 1/2021 Yang ..... D4/101  
 D907,369 S \* 1/2021 Yang ..... D4/101  
 D935,189 S \* 11/2021 He ..... D4/101  
 D935,190 S \* 11/2021 He ..... D4/101  
 D935,194 S \* 11/2021 Yang ..... D4/110  
 2009/0007357 A1\* 1/2009 Meadows ..... A46B 9/005  
 15/167.1  
 2017/0128178 A1 5/2017 Schmidt et al.  
 2018/0140404 A1\* 5/2018 Schaefer ..... A61C 17/34  
 2019/0125065 A1\* 5/2019 Altmann ..... A46B 9/06

OTHER PUBLICATIONS

All Office Actions, U.S. Appl. No. 29/561,313.  
 All Office Actions, U.S. Appl. No. 29/754,305.  
 U.S. Appl. No. 29/754,305, filed Oct. 9, 2020, Niclas Altman et al.

\* cited by examiner

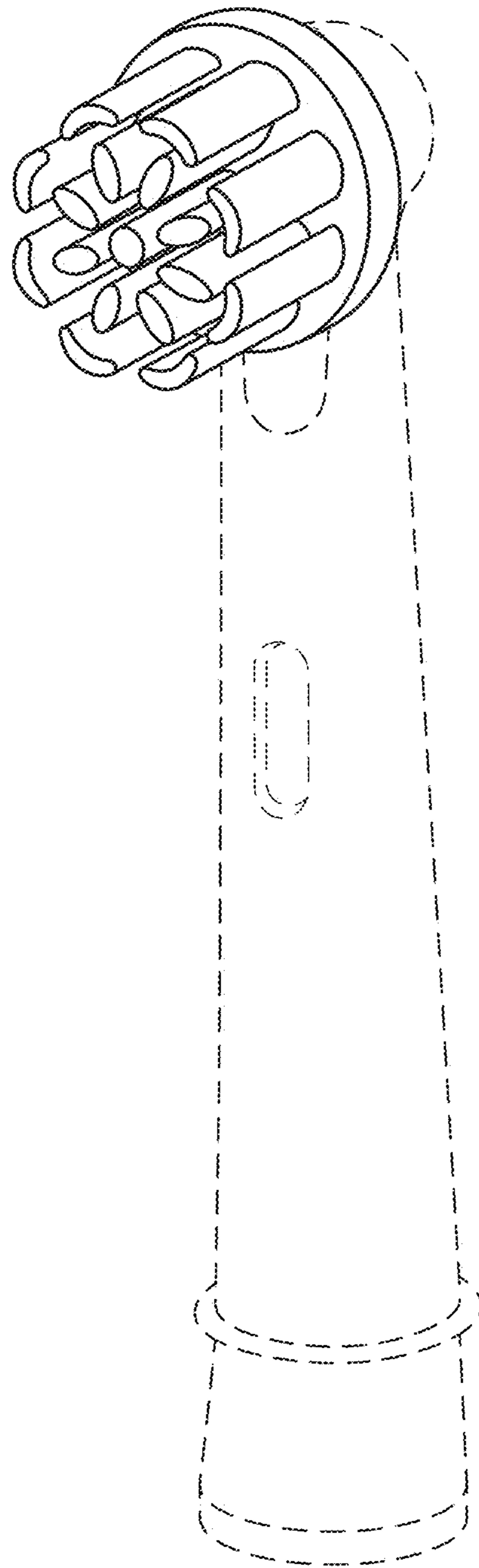

FIG. 1

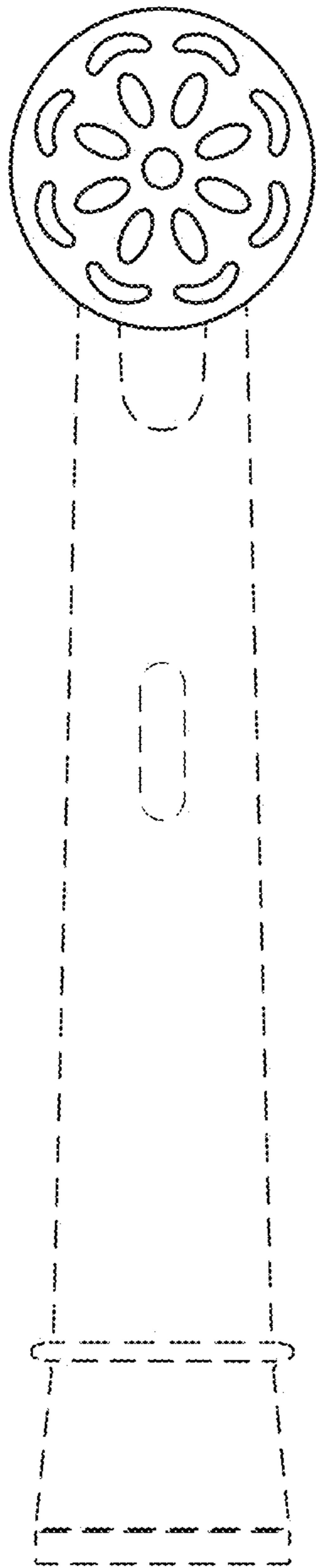

FIG. 2

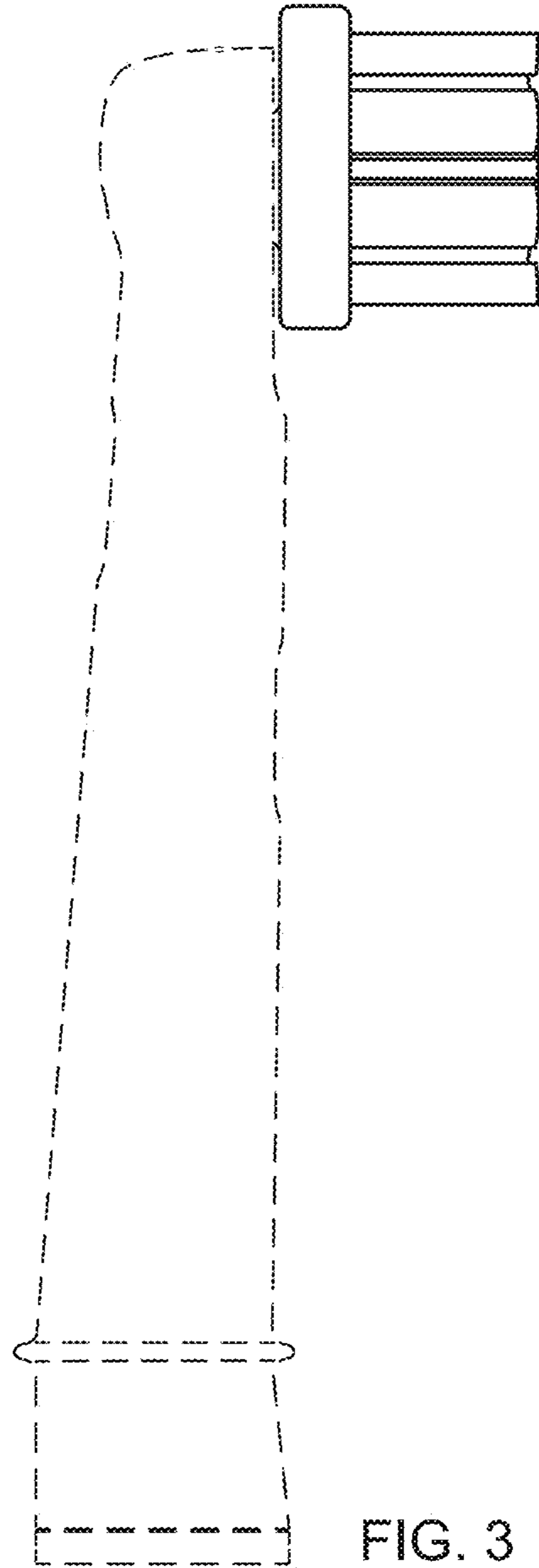

FIG. 3

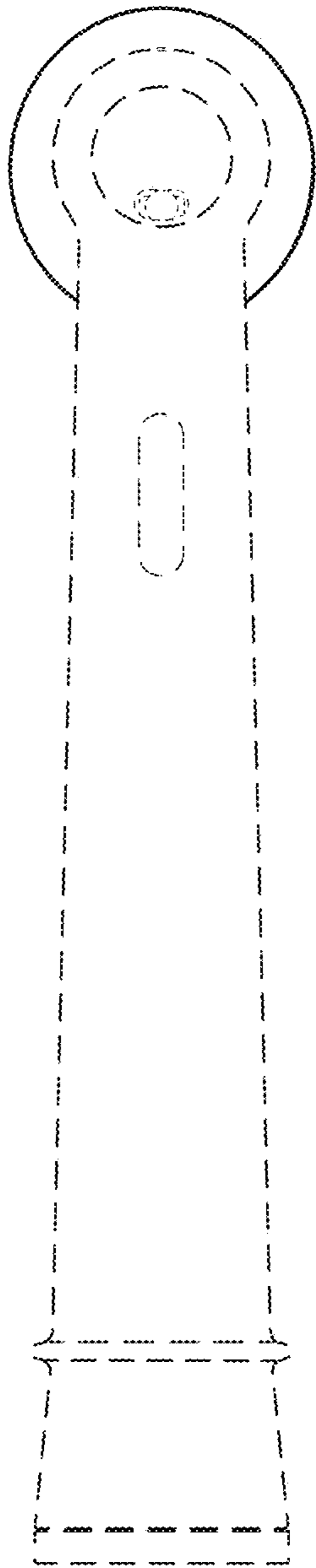

FIG. 4

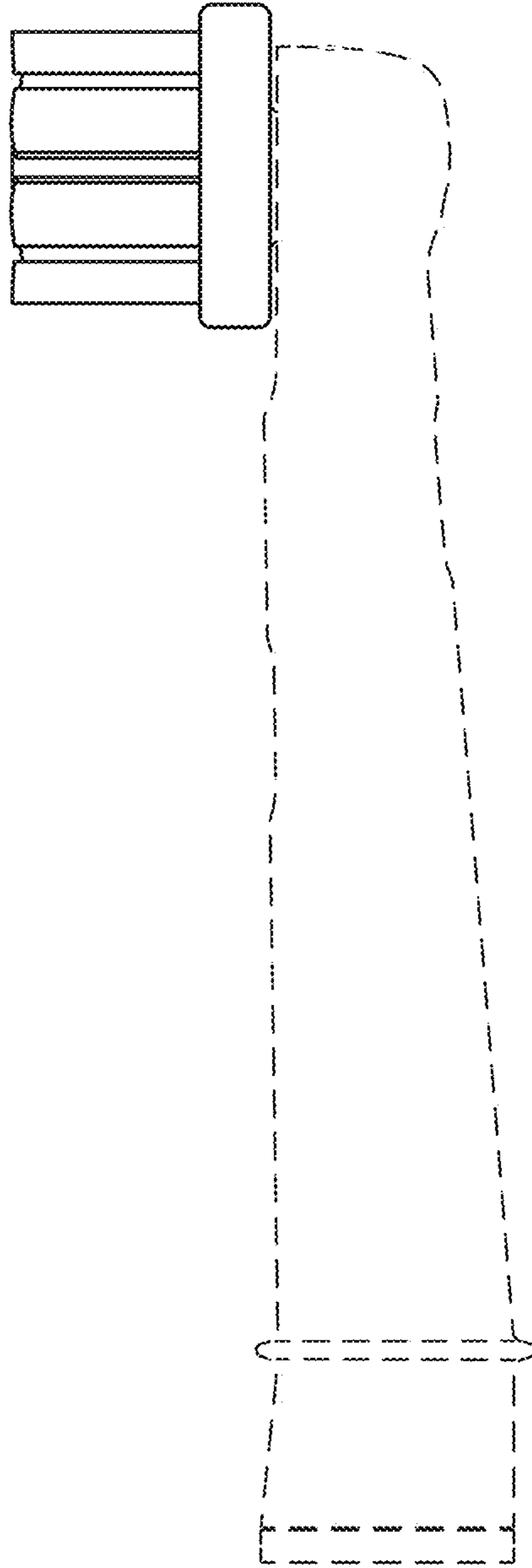

FIG. 5

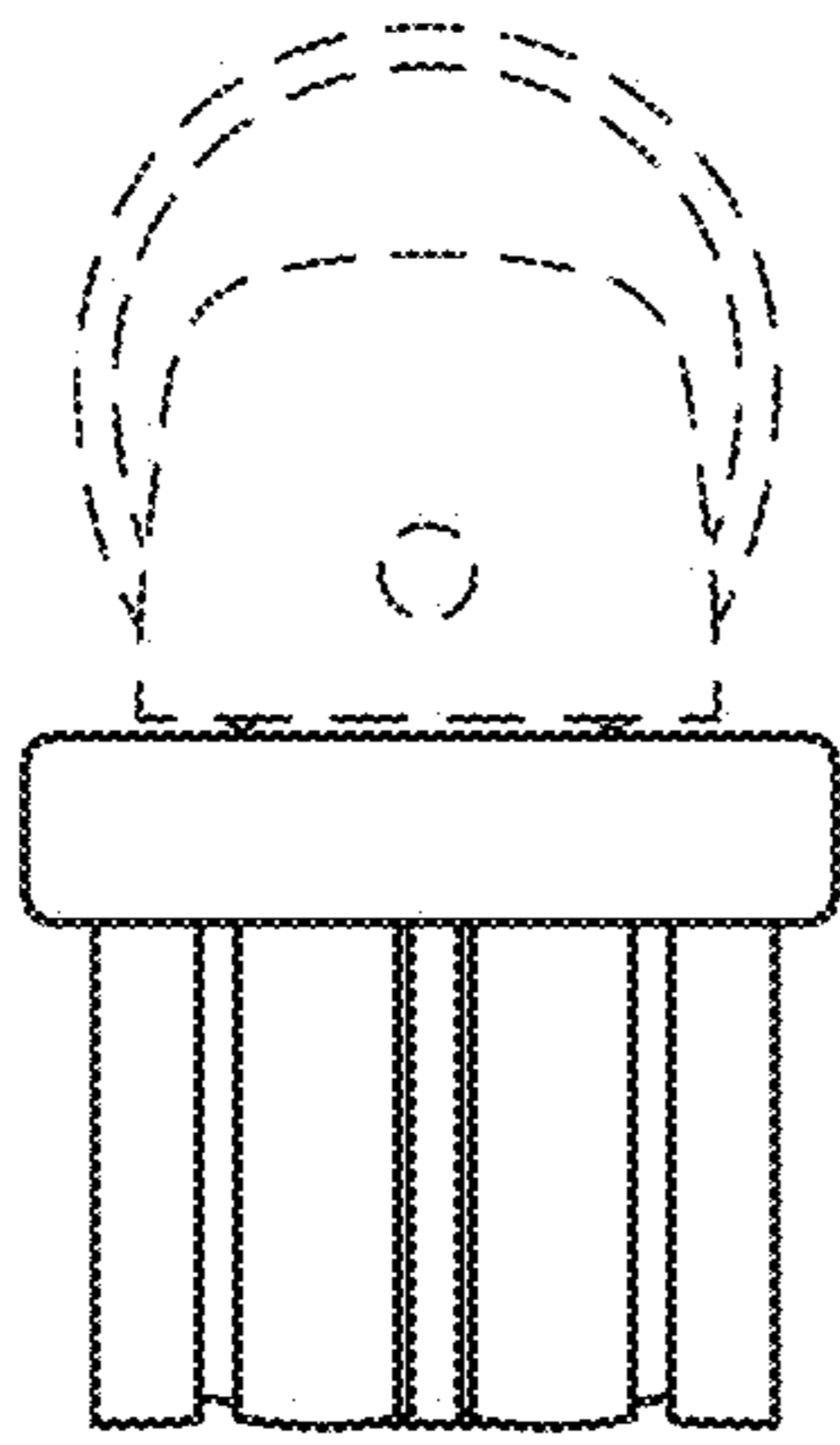

FIG. 6

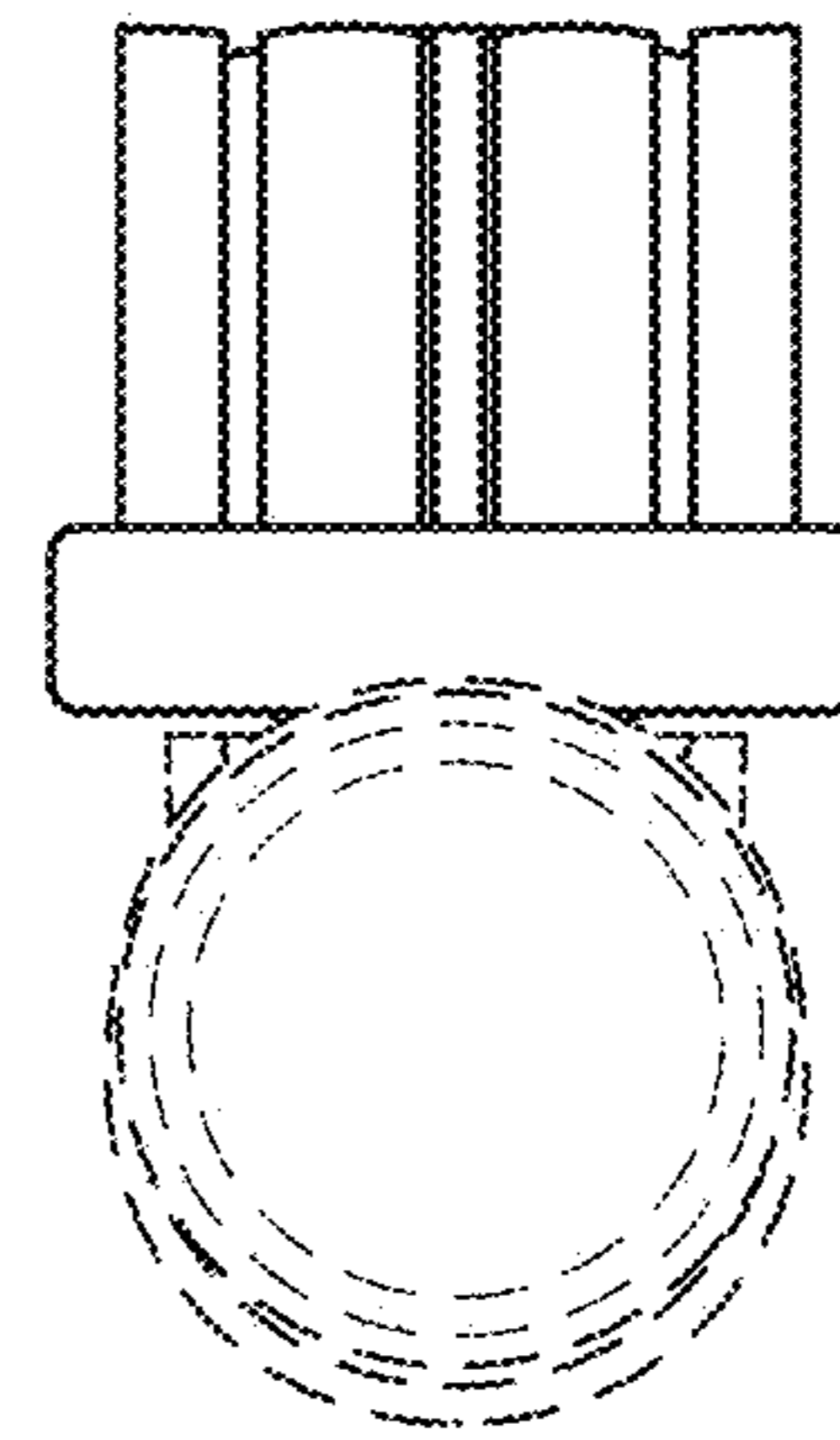

FIG. 7



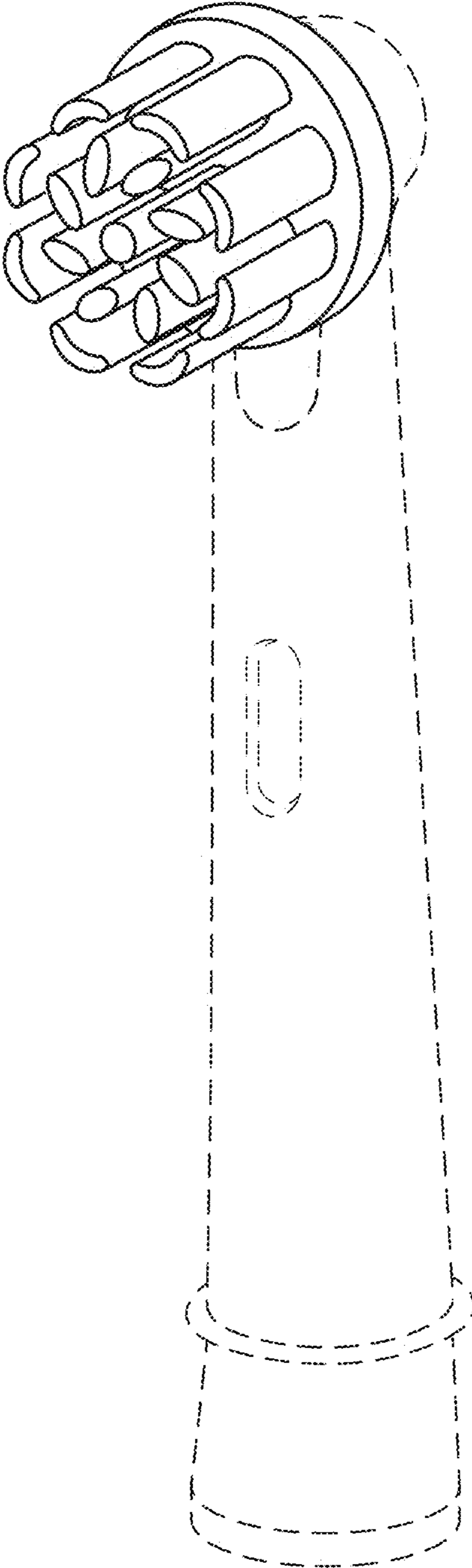

FIG. 8

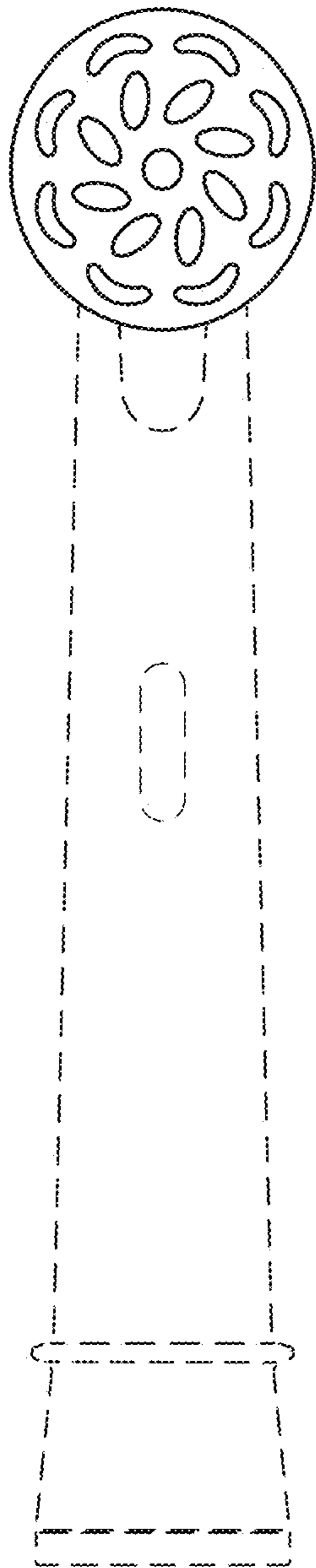

FIG. 9

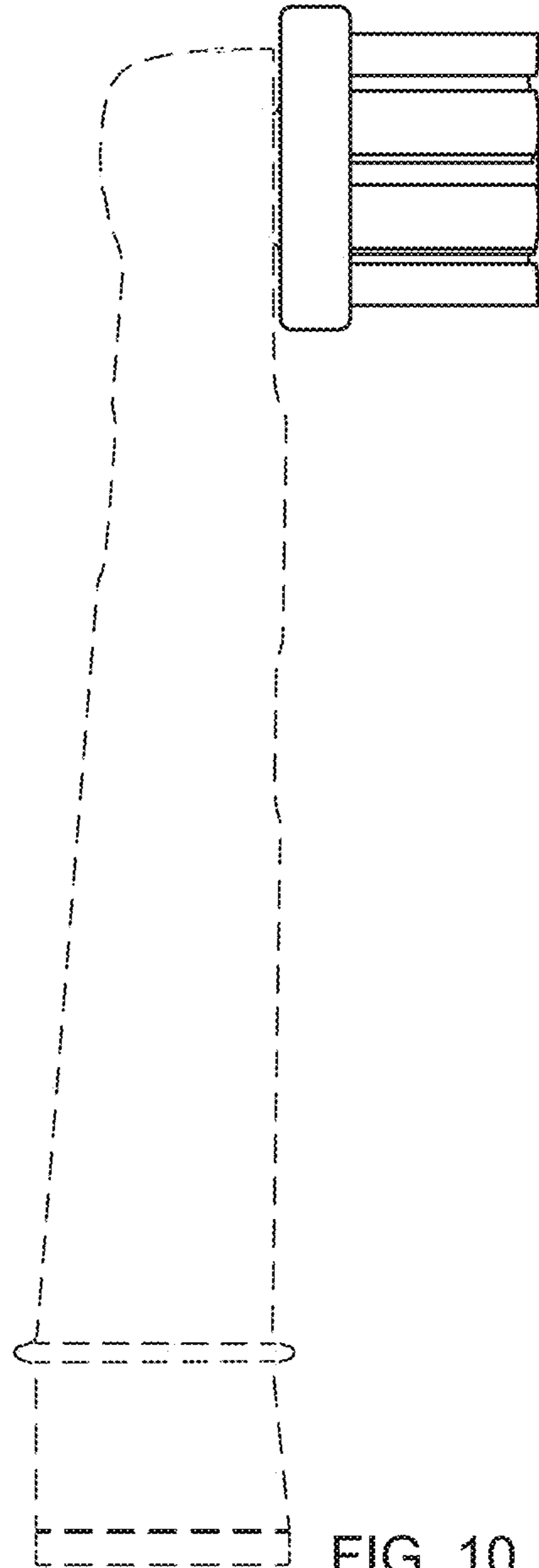

FIG. 10



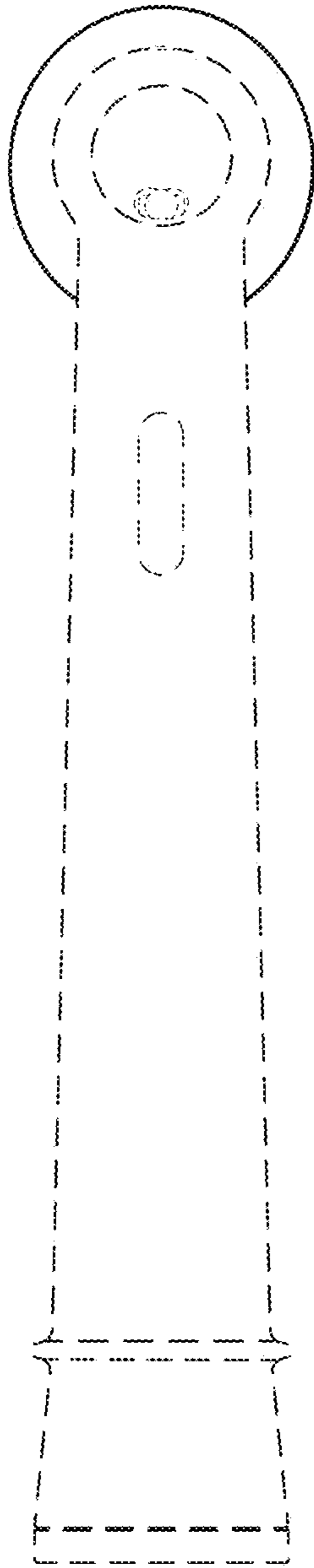

FIG. 11

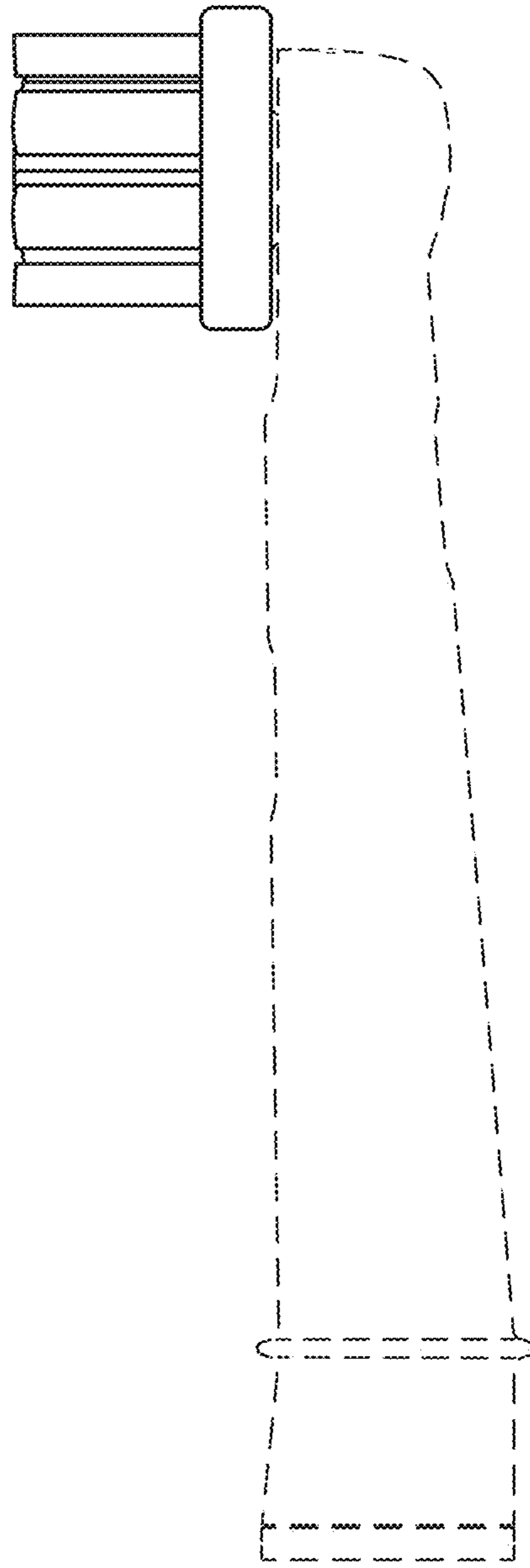

FIG. 12

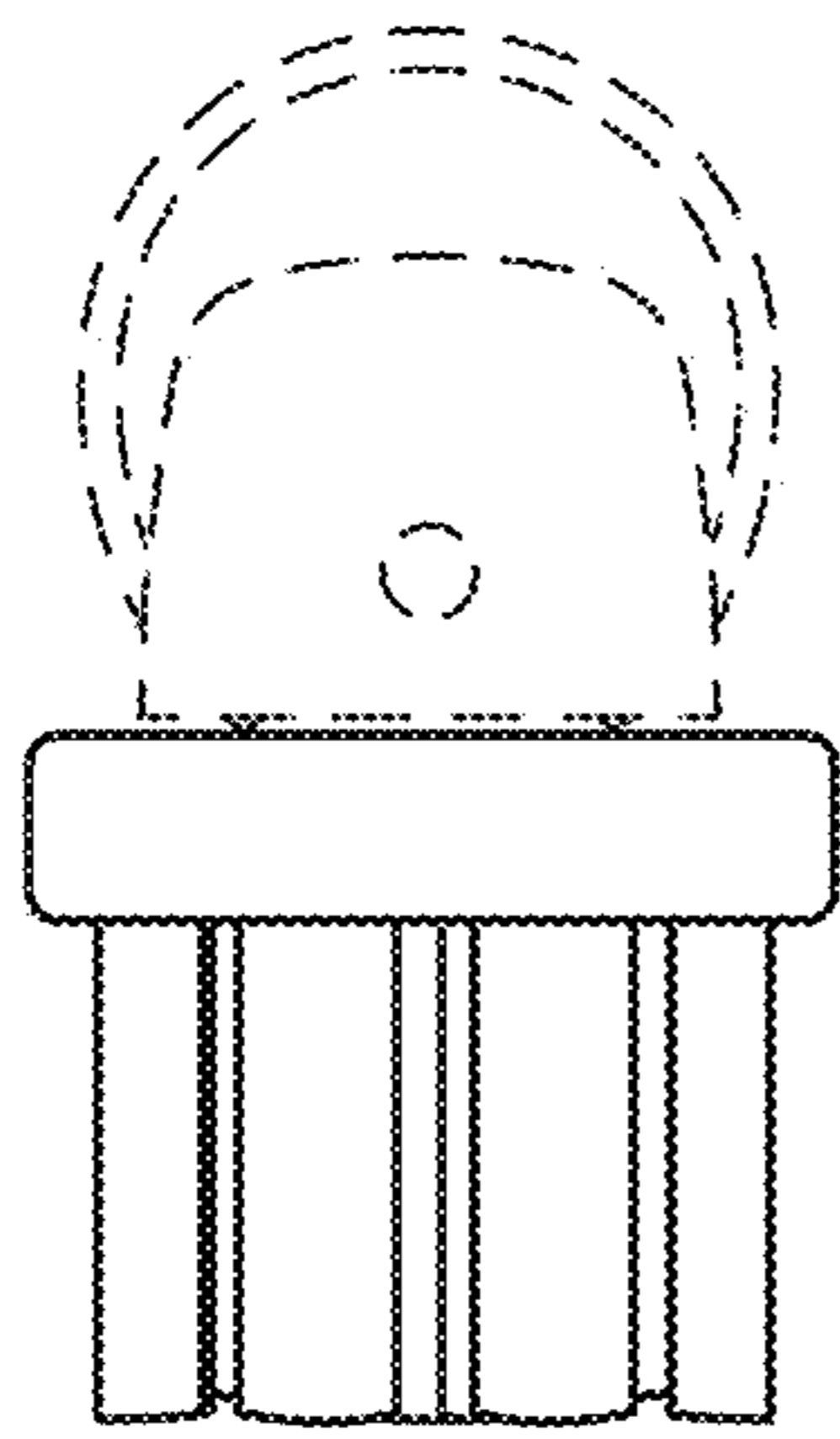

FIG. 13

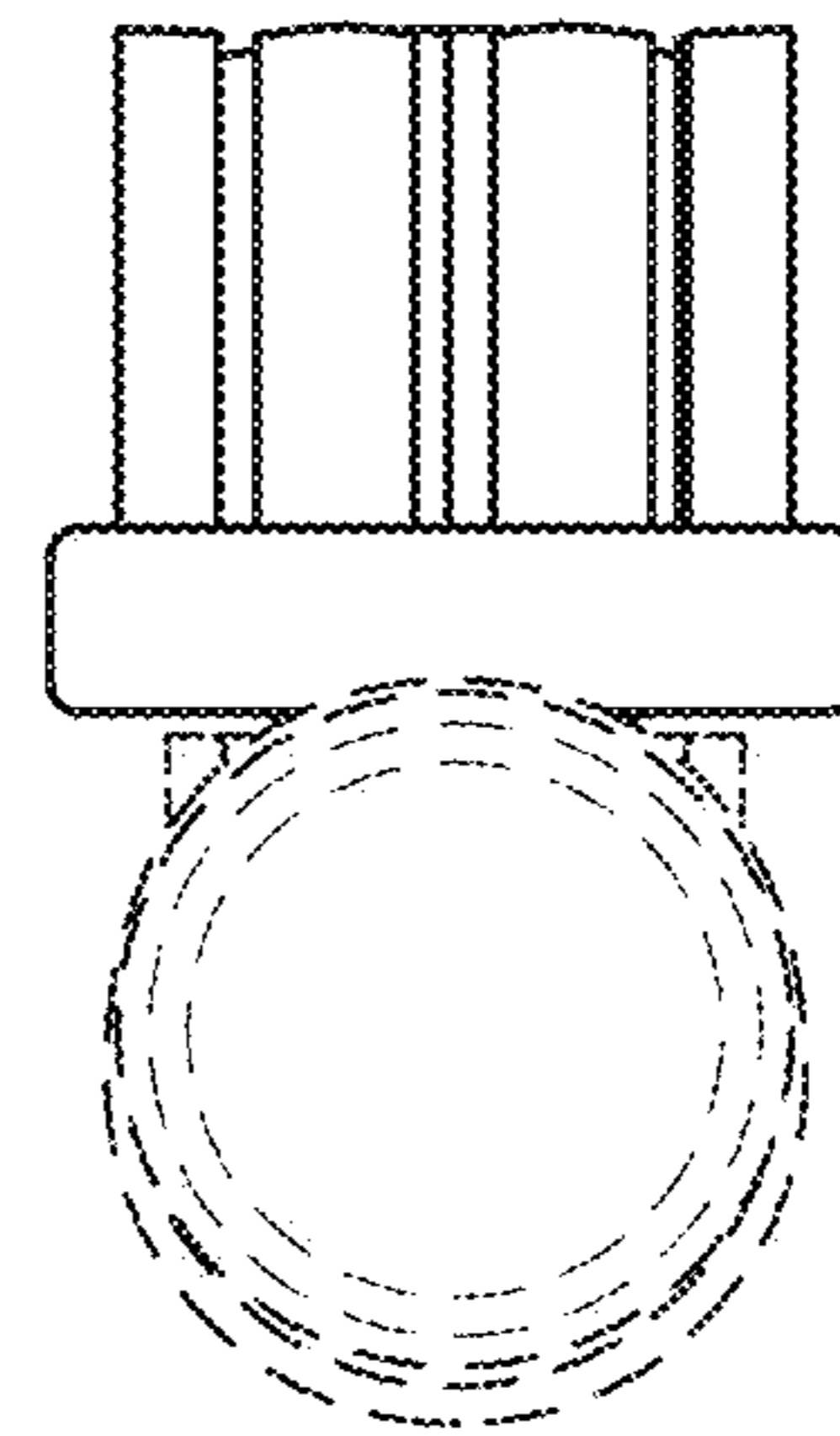

FIG. 14