



US00D952905S

(12) **United States Design Patent**  
**Myung et al.**

(10) **Patent No.:** **US D952,905 S**

(45) **Date of Patent:** **\*\* May 24, 2022**

(54) **DOOR FOR ENTRYWAY WITH REFRIGERATOR AND DELIVERY STORAGE BOX**

F25D 23/025; F25D 23/04; F25D 27/00; F25D 23/062; F25D 23/067; F25D 2400/18; F25D 23/08; F25D 23/085; F25D 2500/02; F25D 25/00; F25D 25/005; F25D 25/022; F25D 25/024; F25D 17/047; F25D 2317/041; F25D 2317/04131; F25D 2317/1043; F25D 2317/0664; F25D 2321/147; F25D 2323/02; F25D 2323/023

(71) Applicant: **LG ELECTRONICS INC.**, Seoul (KR)

(72) Inventors: **Eugene Myung**, Seoul (KR); **Junghoon Lee**, Seoul (KR); **Hyunchul Kim**, Seoul (KR); **Insun Yeo**, Seoul (KR); **Wook Shin**, Seoul (KR); **Kiyeal Seo**, Seoul (KR)

See application file for complete search history.

(73) Assignee: **LG ELECTRONICS INC.**, Seoul (KR)

(\*\*) Term: **15 Years**

(21) Appl. No.: **35/510,342**

(22) Filed: **Mar. 16, 2020**

(80) **Hague Agreement Data**

Int. Filing Date: **Mar. 16, 2020**  
Int. Reg. No.: **DM/207234**  
Int. Reg. Date: **Mar. 16, 2020**  
Int. Reg. Pub. Date: **Sep. 18, 2020**

(30) **Foreign Application Priority Data**

Oct. 2, 2019 (KR) ..... 30-2019-0047429

(51) **LOC (13) Cl.** ..... **25-02**

(52) **U.S. Cl.**  
USPC ..... **D25/48.3**

(58) **Field of Classification Search**  
USPC ..... D15/79-91; 312/112-119, 236, 352, 312/400-408; 62/3.1, 3.6, 3.63, 3.64, 62/293, 31, 371, 400, 467, 529, 531; D25/48.1, 48.3

CPC ..... F25D 25/025; F25D 23/028; F25D 2323/024; F25D 23/00; F25D 23/02; F25D 2323/021; F25D 23/065; F25D 11/00; F25D 2201/14; F25D 23/021;

(56) **References Cited**

U.S. PATENT DOCUMENTS

2,404,851 A \* 7/1946 Knowles ..... F25D 25/025  
312/286  
2,421,439 A \* 6/1947 Smith ..... F25D 13/02  
62/382

(Continued)

*Primary Examiner* — Richard E Chilcot

(74) *Attorney, Agent, or Firm* — Birch, Stewart, Kolasch & Birch, LLP

(57) **CLAIM**

The ornamental design for a door for entryway with refrigerator and delivery storage box, as shown and described.

**DESCRIPTION**

- 1. Door for entryway with refrigerator and delivery storage box
- 1.1 : Perspective
- 1.2 : Front
- 1.3 : Back
- 1.4 : Left
- 1.5 : Right
- 1.6 : Top
- 1.7 : Bottom

The shading lines in the reproductions are used to show the translucent material of the claimed design, and do not

(Continued)

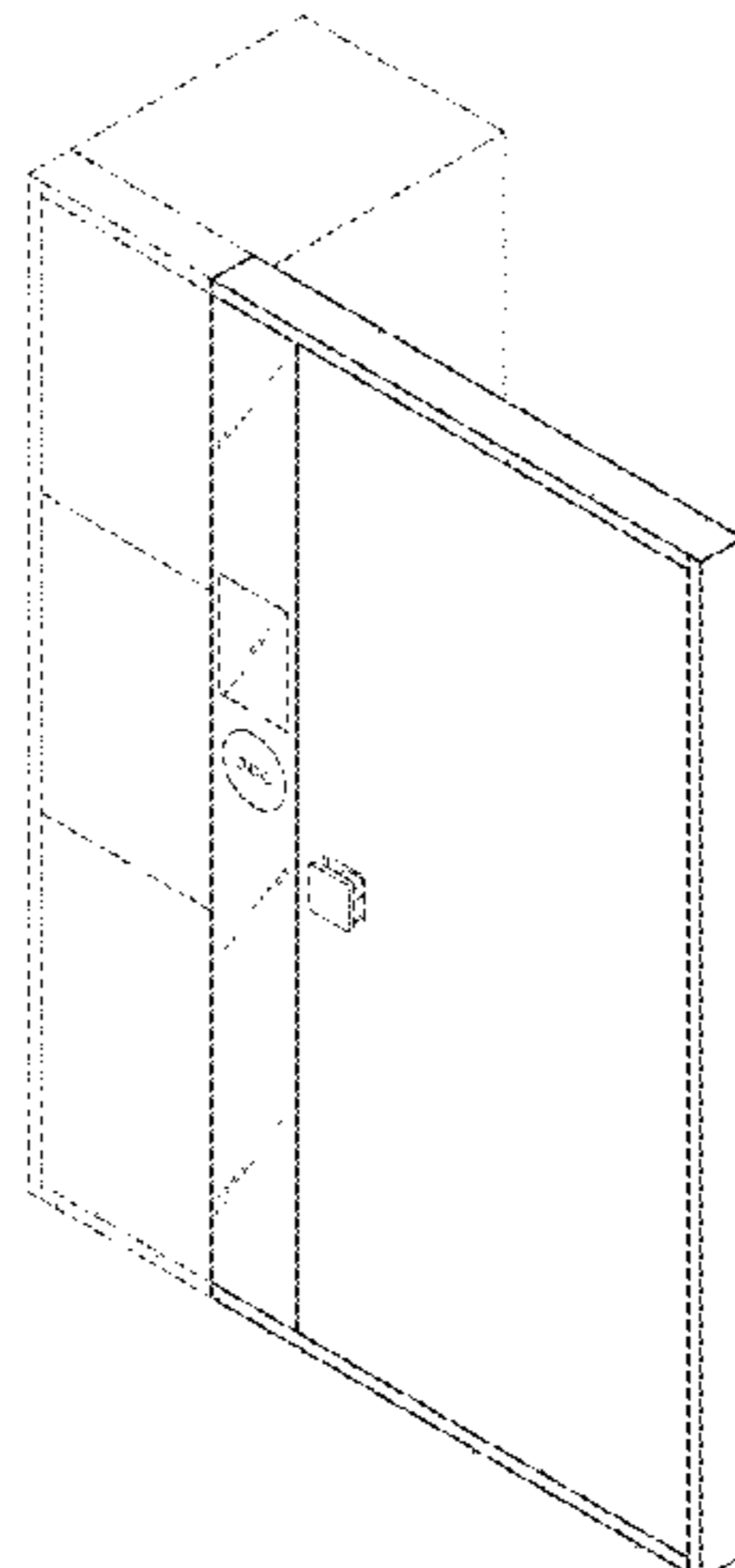

# US D952,905 S

Page 2

represent its surface ornamentation; broken lines illustrate environmental condition only and form no part thereof.

## 1 Claim, 7 Drawing Sheets

(52) **U.S. Cl.**  
CPC ..... *E04B 2/00* (2013.01)

(56) **References Cited**

### U.S. PATENT DOCUMENTS

3,089,313 A \* 5/1963 Fix ..... F25D 13/02  
62/239  
5,474,213 A \* 12/1995 Unger ..... F25C 5/22  
222/108  
D443,625 S \* 6/2001 Vazquez ..... D15/86  
D471,568 S \* 3/2003 Smith ..... D15/85  
D544,000 S \* 6/2007 Ohtake ..... D15/81  
D669,103 S \* 10/2012 Behr ..... D15/91  
D671,573 S \* 11/2012 Behr ..... D15/91  
8,496,308 B2 \* 7/2013 Zabbatino ..... G06Q 30/0645  
312/407  
8,814,286 B2 \* 8/2014 Ward ..... F25D 25/024  
312/404  
D880,543 S \* 4/2020 Luchetta ..... D15/91

D905,766 S \* 12/2020 Vernon ..... D15/79  
D918,055 S \* 5/2021 Smith, Jr. .... D9/636  
D924,278 S \* 7/2021 Choi ..... F25D 25/025  
D15/79  
2003/0005716 A1 \* 1/2003 Doran ..... F25D 23/10  
62/263  
2006/0179724 A1 \* 8/2006 Lee ..... A47G 29/141  
52/79.1  
2008/0036238 A1 \* 2/2008 Weeda ..... B60P 3/20  
296/146.1  
2008/0278335 A1 \* 11/2008 Welte ..... G07C 9/28  
340/573.3  
2009/0236954 A1 \* 9/2009 Kobayashi ..... A47F 3/0404  
312/36  
2010/0256800 A1 \* 10/2010 Heffron ..... G07F 11/62  
700/214  
2012/0206029 A1 \* 8/2012 Zabbatino ..... F25D 23/025  
312/404  
2012/0209763 A1 \* 8/2012 Zabbatino ..... G06Q 30/0645  
705/39  
2017/0061373 A1 \* 3/2017 Hara ..... A47G 29/141  
2017/0188542 A1 \* 7/2017 Dix ..... A01K 1/035  
2017/0286905 A1 \* 10/2017 Richardson ..... G06Q 10/0832  
2018/0172337 A1 \* 6/2018 Choi ..... F25D 23/02  
2019/0257556 A1 \* 8/2019 Pinet ..... A47F 3/0434  
2019/0271500 A1 \* 9/2019 Lee ..... F25D 23/02  
2021/0217261 A1 \* 7/2021 Green ..... G08C 17/02

\* cited by examiner

1.1

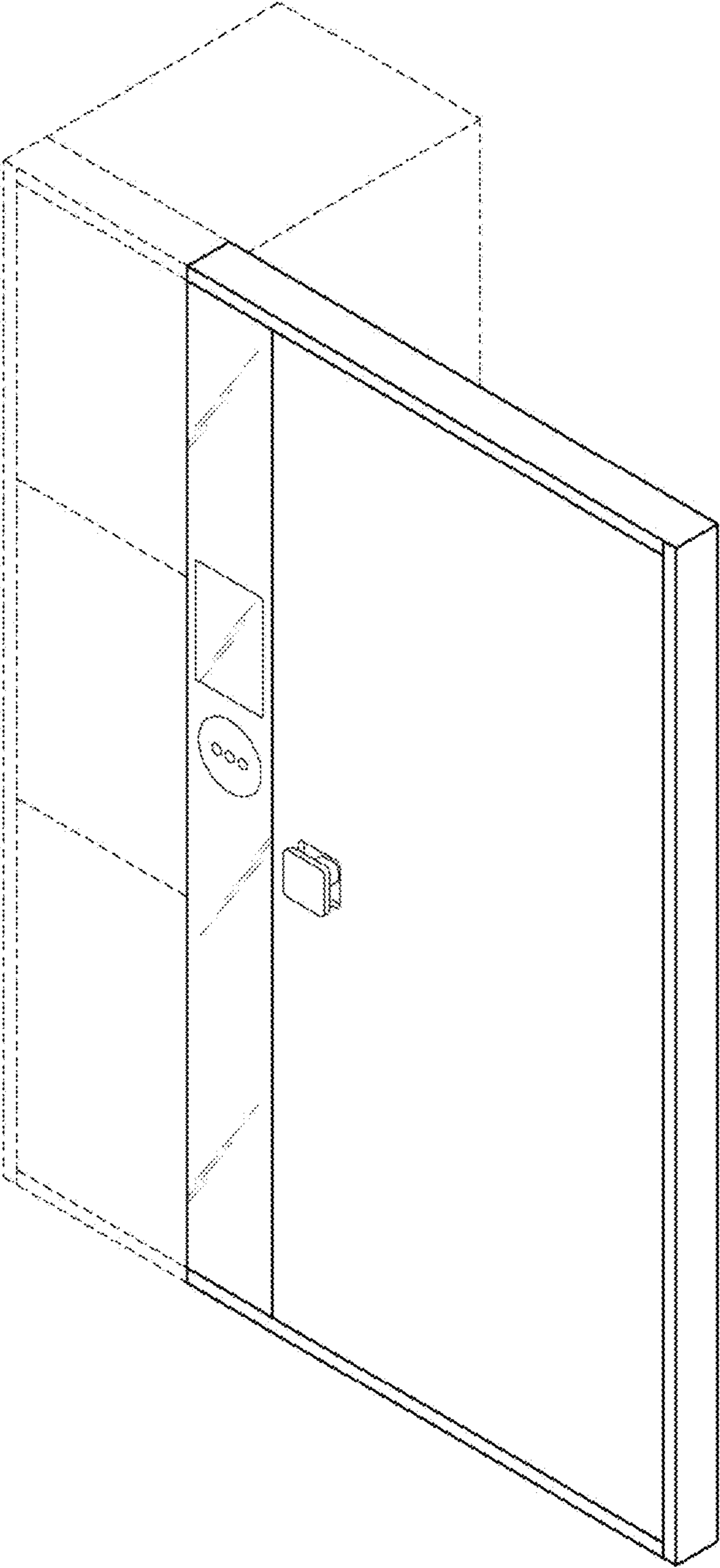

1.2

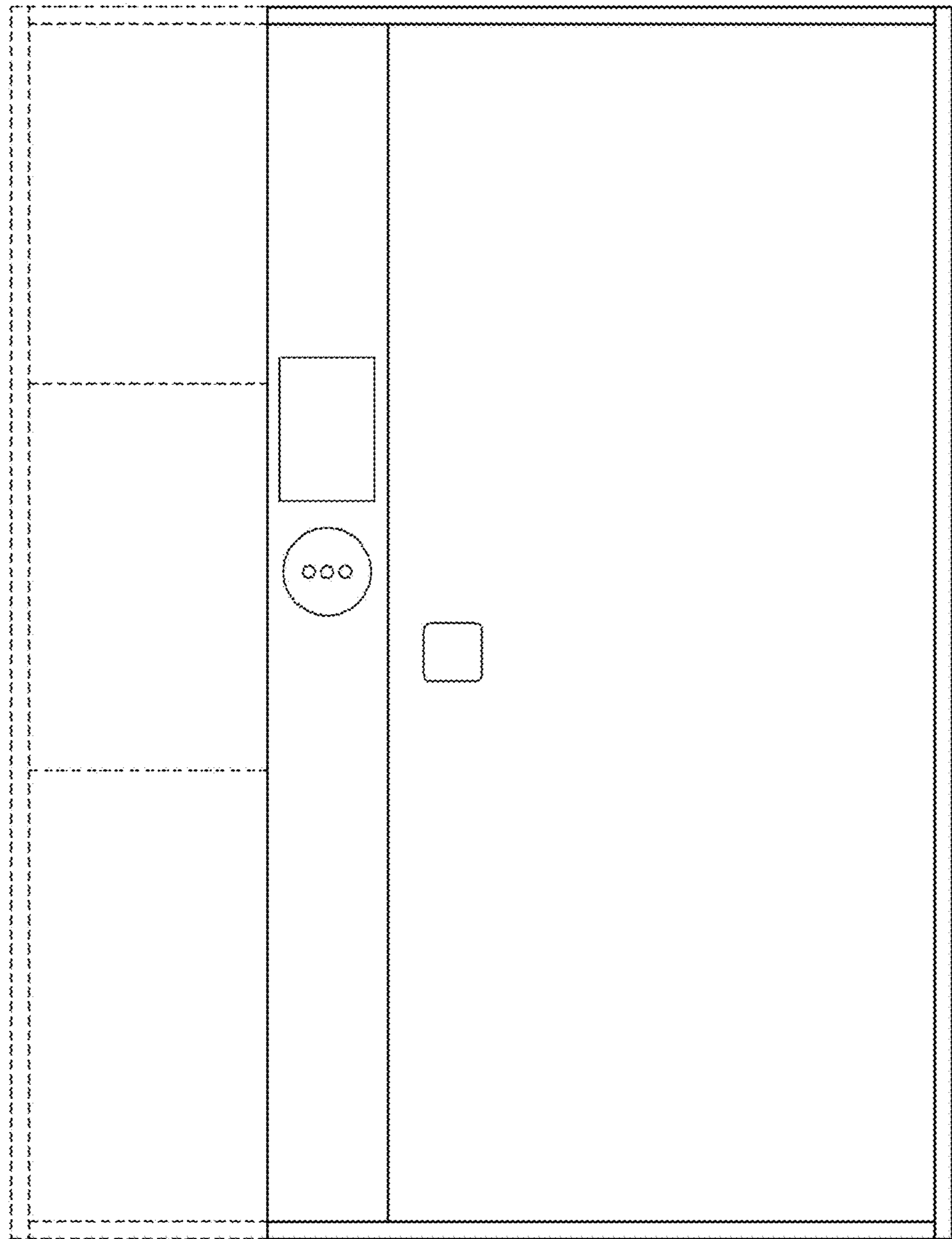

1.3

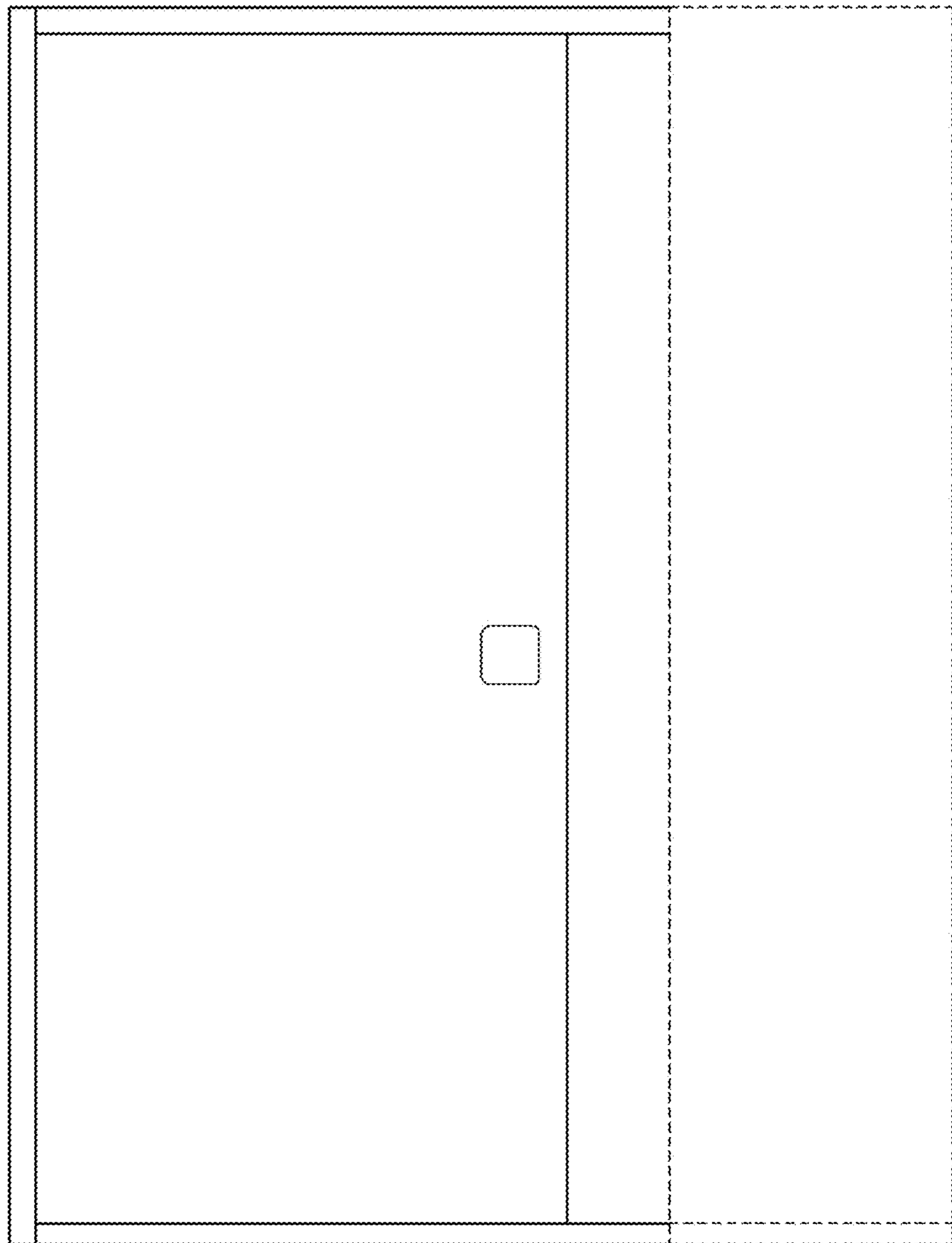

1.4

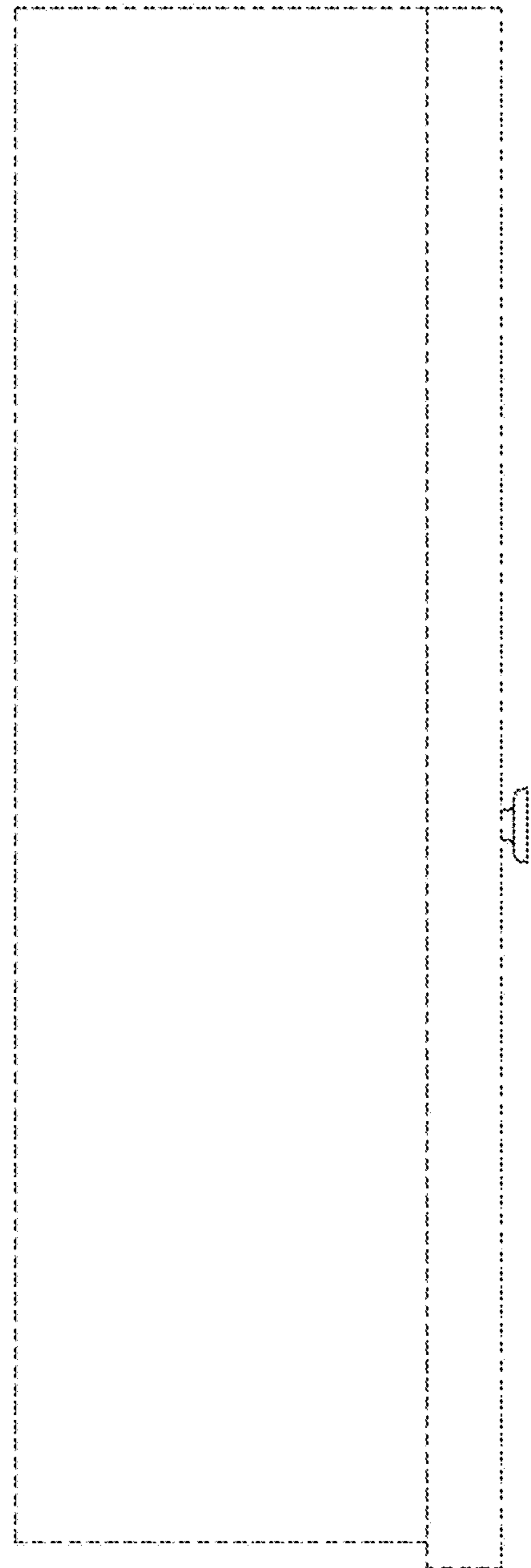

1.5

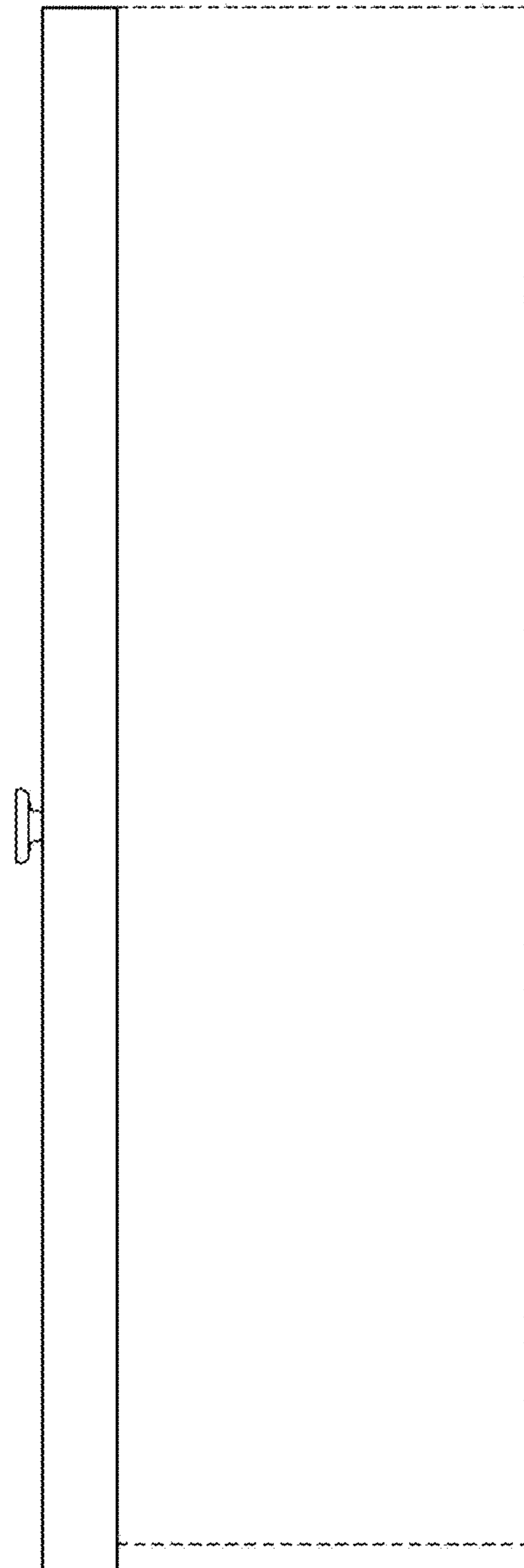

1.6

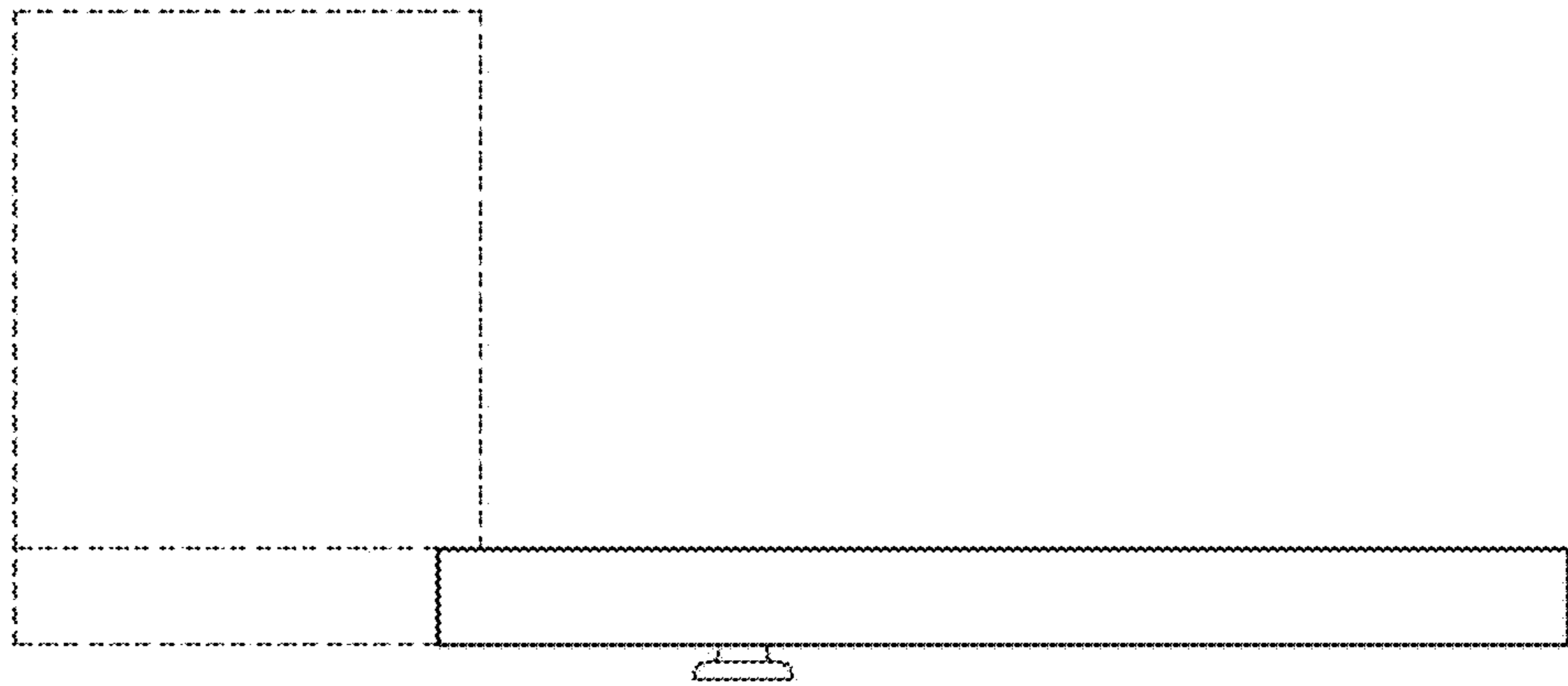



1.7

