



US00D952835S

(12) **United States Design Patent** (10) **Patent No.:** **US D952,835 S**
Van Der Beek et al. (45) **Date of Patent:** **** May 24, 2022**

(54) **INJECTOR PEN**
(71) Applicant: **Novo Nordisk A/S**, Bagsværd (DK)
(72) Inventors: **Willem Van Der Beek**, Virum (DK);
Camilla Damgaard-Sørensen, Lyngby (DK)
(73) Assignee: **Novo Nordisk A/S**, Bagsværd (DK)

D816,212 S 4/2018 Daniel et al.
D819,200 S * 5/2018 Stonecipher D24/114
D821,573 S 6/2018 Daniel et al.
D822,199 S * 7/2018 Clawson D24/113
D834,706 S 11/2018 Daniel et al.
D834,707 S 11/2018 Daniel et al.
D866,757 S * 11/2019 Diluzio D24/133
D868,245 S 11/2019 Holmqvist et al.

(Continued)

(**) Term: **15 Years**
(21) Appl. No.: **29/741,752**

(22) Filed: **Jul. 15, 2020**

(51) **LOC (13) Cl.** **24-02**

(52) **U.S. Cl.**
USPC **D24/114**

(58) **Field of Classification Search**
USPC D24/104, 107, 108, 112–114, 117–119,
D24/127, 130, 133, 186; 604/181, 184,
604/187, 264, 227, 272; 606/181, 185
CPC A61M 5/178; A61M 5/20; A61M 5/31;
A61M 5/3146; A61M 5/3129; A61M
5/3148; A61M 5/315; A61M 3/00
See application file for complete search history.

(56) **References Cited**

U.S. PATENT DOCUMENTS

D627,061 S * 11/2010 Van der Stappen D24/113
D660,958 S * 5/2012 McLoughlin A61M 5/31535
D24/113
D707,351 S * 6/2014 Kunze D24/112
8,911,402 B2 * 12/2014 Veasey A61M 5/20
604/122
D758,570 S * 6/2016 Wohlfahrt D24/113
D794,178 S 8/2017 Daniel et al.
D794,777 S 8/2017 Daniel et al.
D794,778 S 8/2017 Daniel et al.
9,750,885 B2 * 9/2017 Weaver A61M 5/3234
D810,281 S 2/2018 Holmqvist et al.
D815,734 S * 4/2018 Burke D24/119

OTHER PUBLICATIONS

[Auto Injectors & Pen Injectors: a User-Centric Design Approach], available on ondrugdelivery.com, Published [2015] [online], [site visited Dec. 13, 2021], Internet URL: <https://www.ondrugdelivery.com/wp-content/uploads/2017/05/SHL-HR.pdf>. (Year: 2015).*

(Continued)

Primary Examiner — Jonathan J Han
Assistant Examiner — Amanda J Berlinski
(74) *Attorney, Agent, or Firm* — Saidman DesignLaw Group, LLC

(57) **CLAIM**

The ornamental design for an injector pen, as shown and described.

DESCRIPTION

FIG. 1 is a perspective view of an injector pen showing our new design;
FIG. 2 is another perspective view thereof;
FIG. 3 is a front view thereof;
FIG. 4 is a rear view thereof;
FIG. 5 is a left side view thereof;
FIG. 6 is a right side view thereof;
FIG. 7 is a top view thereof; and,
FIG. 8 is a bottom view thereof.
The broken lines illustrate structure or features of the injector pen that form no part of the claimed design.

1 Claim, 5 Drawing Sheets

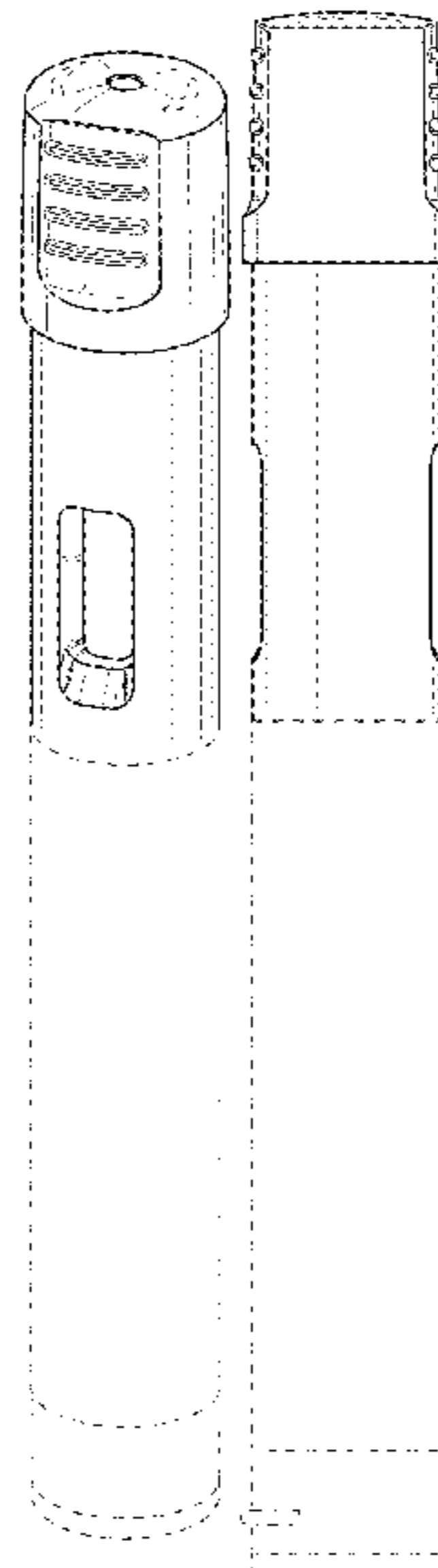

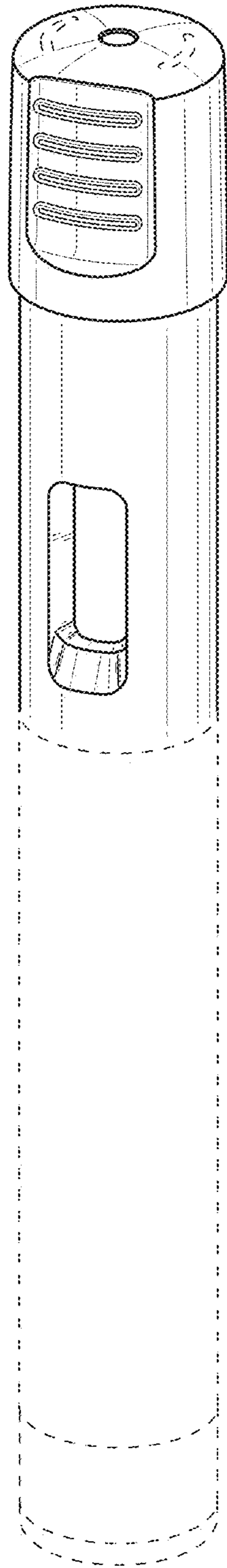

Fig. 1

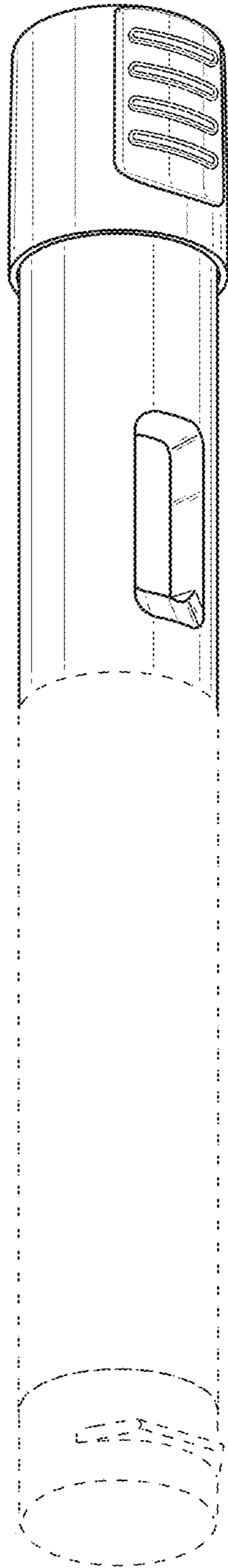

Fig. 2

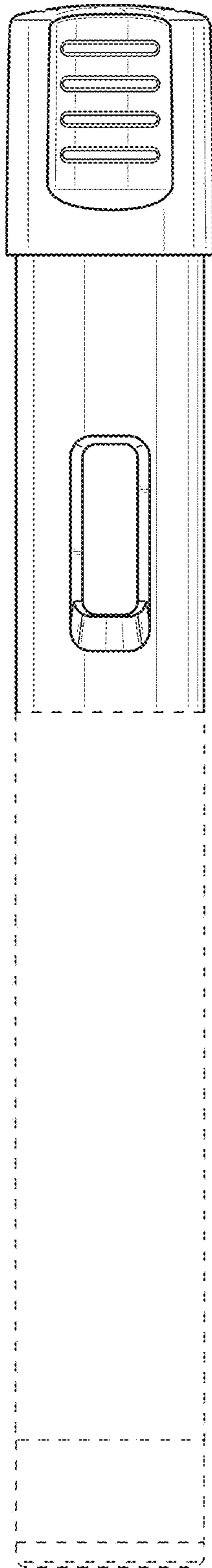

Fig. 3

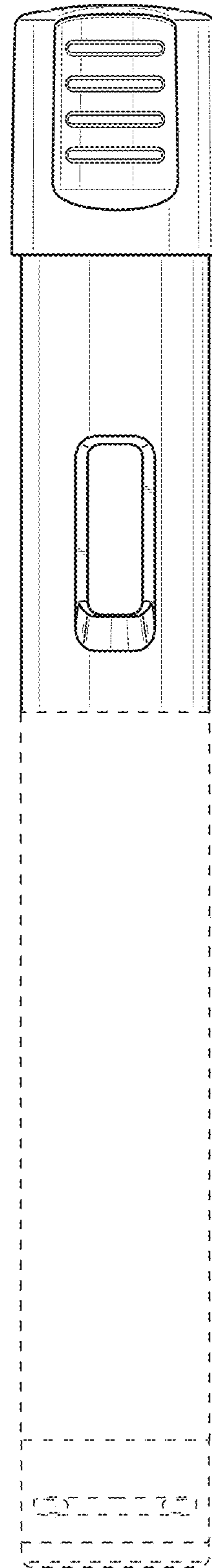

Fig. 4

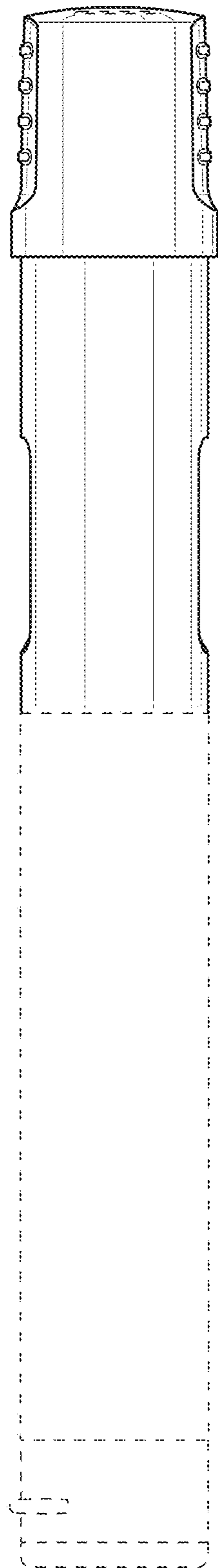

Fig. 5

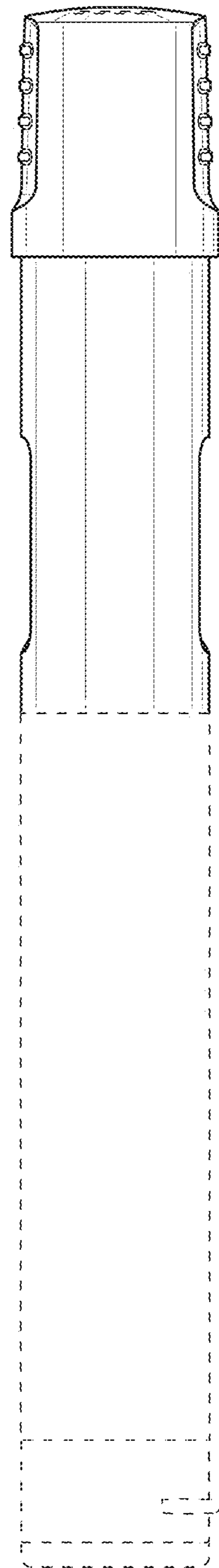

Fig. 6

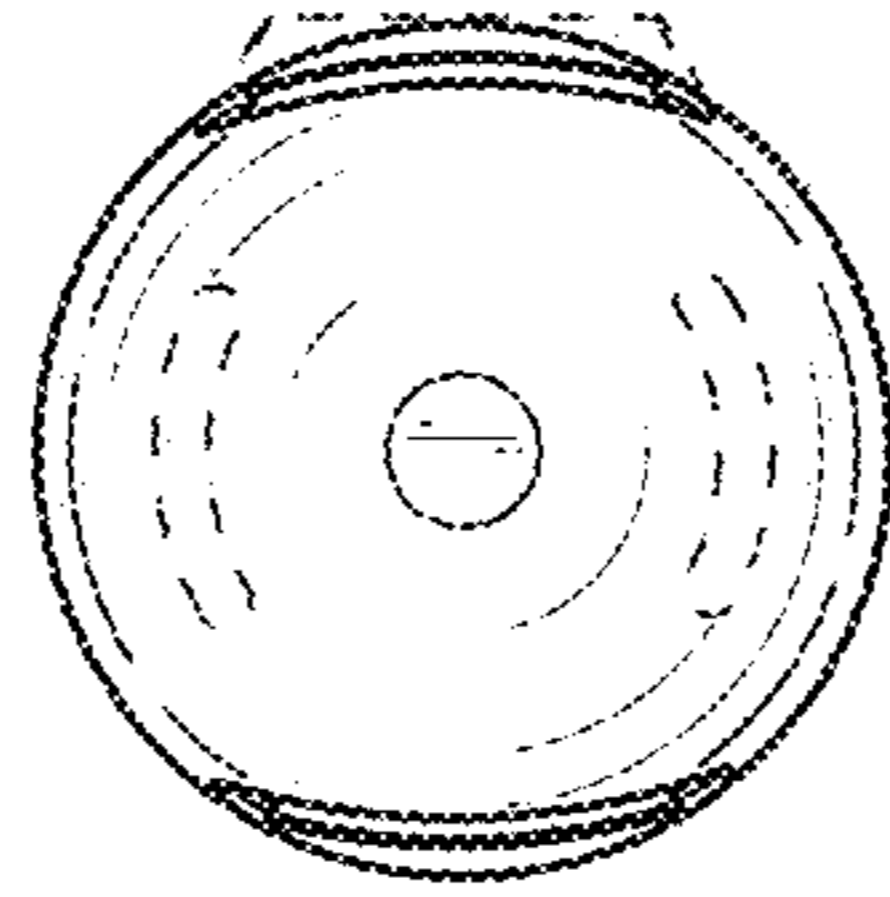

Fig. 7

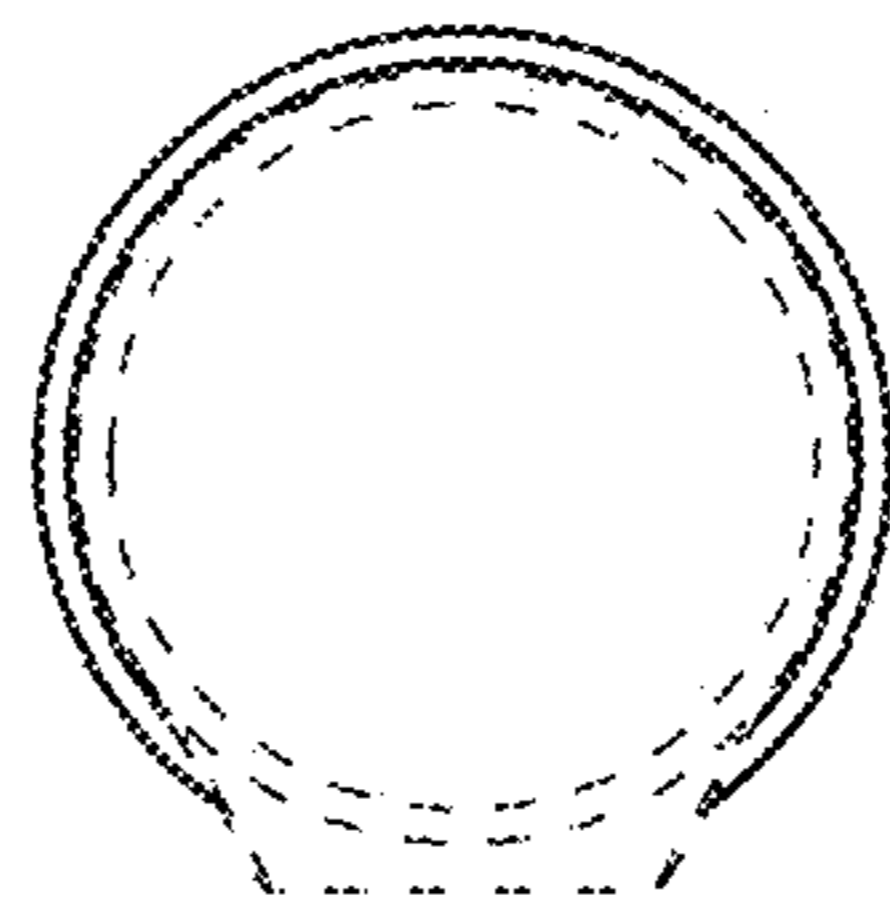

Fig. 8