



US00D952812S

(12) **United States Design Patent**  
**Norman**

(10) **Patent No.:** **US D952,812 S**  
(45) **Date of Patent:** **\*\* May 24, 2022**

(54) **FIRE PIT**

2011/0132347 A1\* 6/2011 Kim ..... A47J 37/0763  
126/25 R

(71) Applicant: **Thomas A. Norman**, Dayton, OH (US)

\* cited by examiner

(72) Inventor: **Thomas A. Norman**, Dayton, OH (US)

*Primary Examiner* — Ania Aman

(\*\*) Term: **15 Years**

(74) *Attorney, Agent, or Firm* — Porter, Wright, Morris & Arthur, LLP

(21) Appl. No.: **29/754,943**

(57) **CLAIM**

The ornamental design for a fire pit, as shown and described.

(22) Filed: **Oct. 15, 2020**

**DESCRIPTION**

(51) **LOC (13) Cl.** ..... **23-03**

(52) **U.S. Cl.**

USPC ..... **D23/335**; D23/343

(58) **Field of Classification Search**

USPC ..... D23/332, 314, 343, 348, 350, 346, 342,  
D23/335; D7/332–337, 402–405, 352

CPC ..... F24C 1/16; F24C 5/00; F24C 3/14; A47J  
33/00; A47J 37/0763; A47J 37/07; F24B  
1/18; F24B 1/182; F24B 1/1808; F24B  
1/181; F24B 1/195; F24B 1/191

See application file for complete search history.

FIG. 1 is a front/left perspective view of a fire pit according to my new design, wherein the fire pit is in a fully-closed configuration;

FIG. 2 is a front view thereof;

FIG. 3 is a rear view thereof;

FIG. 4 is a top view thereof;

FIG. 5 is a bottom view thereof;

FIG. 6 is a left-side view thereof;

FIG. 7 is a right-side view thereof;

FIG. 8 is a front/left perspective view of the fire pit of FIGS. 1 to 7 but wherein the fire pit is in a fully open configuration;

FIG. 9 is a front view thereof;

FIG. 10 is a rear view thereof;

FIG. 11 is a top view thereof;

FIG. 12 is a bottom view thereof;

FIG. 13 is a left-side view thereof; and,

FIG. 14 is a right-side view thereof.

The broken lines in the drawing depict portions of the fire pit that form no portion of the claimed design.

(56) **References Cited**

U.S. PATENT DOCUMENTS

D757,238 S \* 5/2016 Horsfield ..... D23/343  
D831,806 S 10/2018 Frasher  
D836,187 S 12/2018 Frasher  
D844,125 S \* 3/2019 Horsfield ..... D23/343  
D865,929 S 11/2019 Hughes  
D932,228 S \* 10/2021 Liu ..... D7/332

**1 Claim, 14 Drawing Sheets**

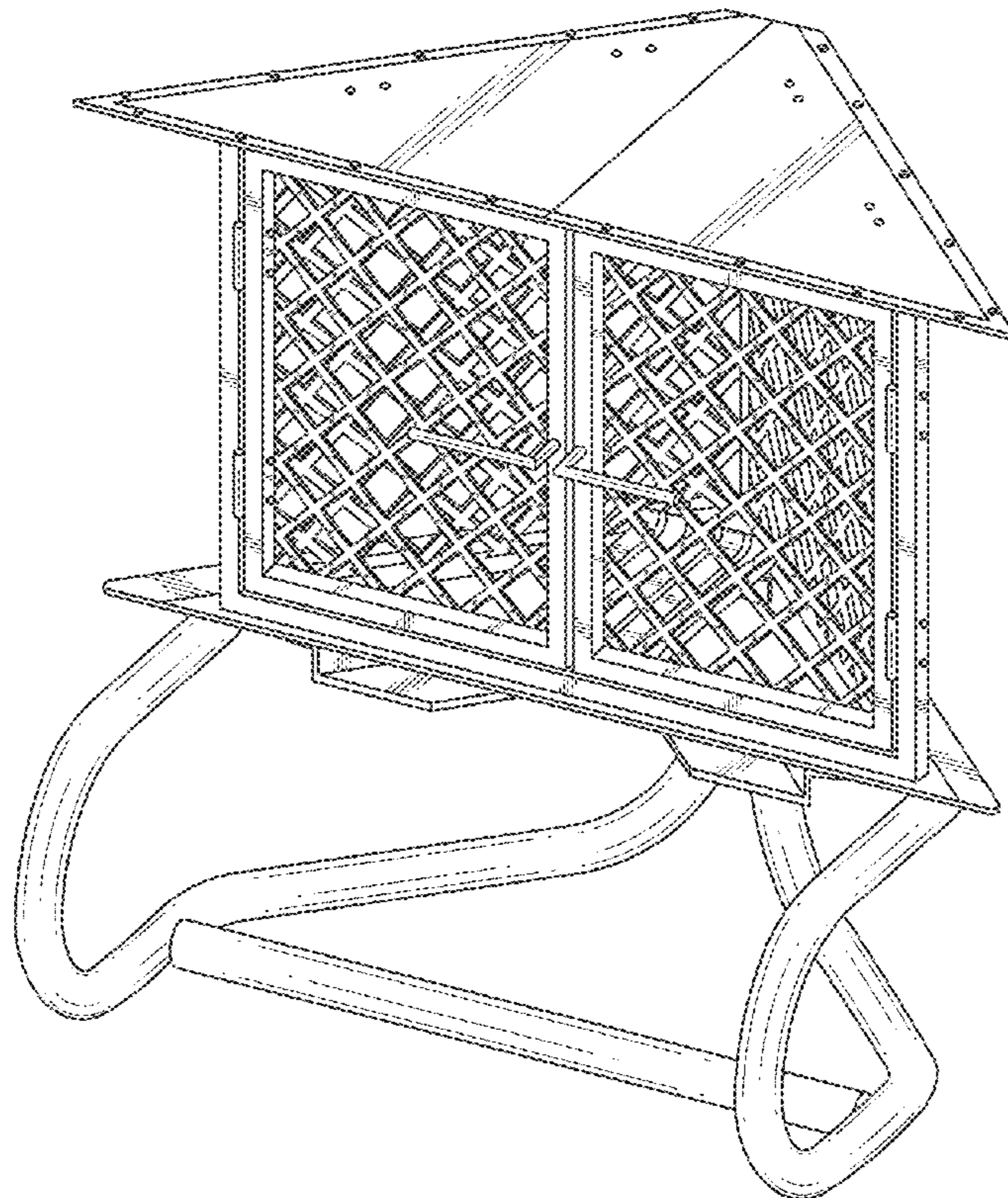

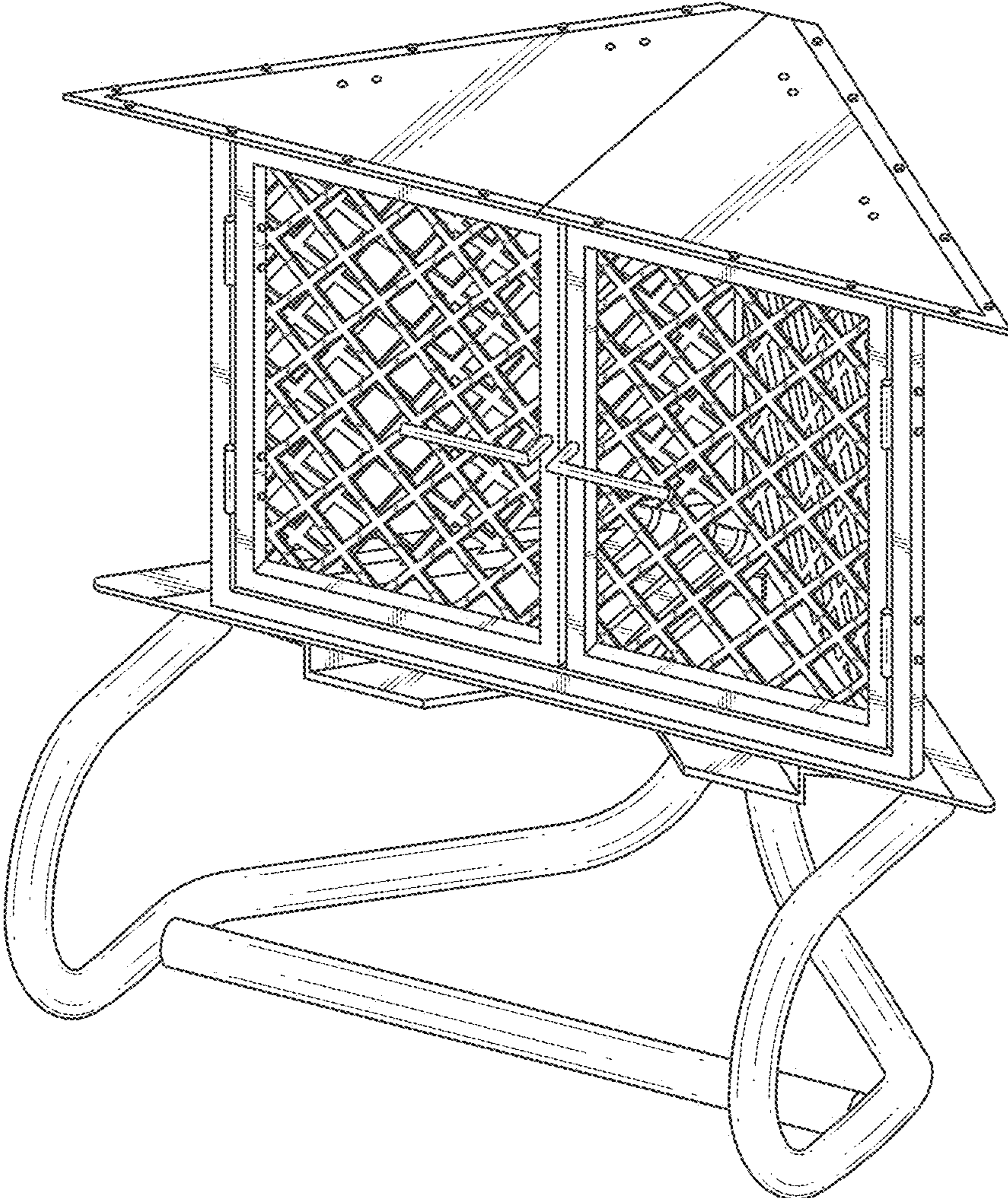

FIG. 1

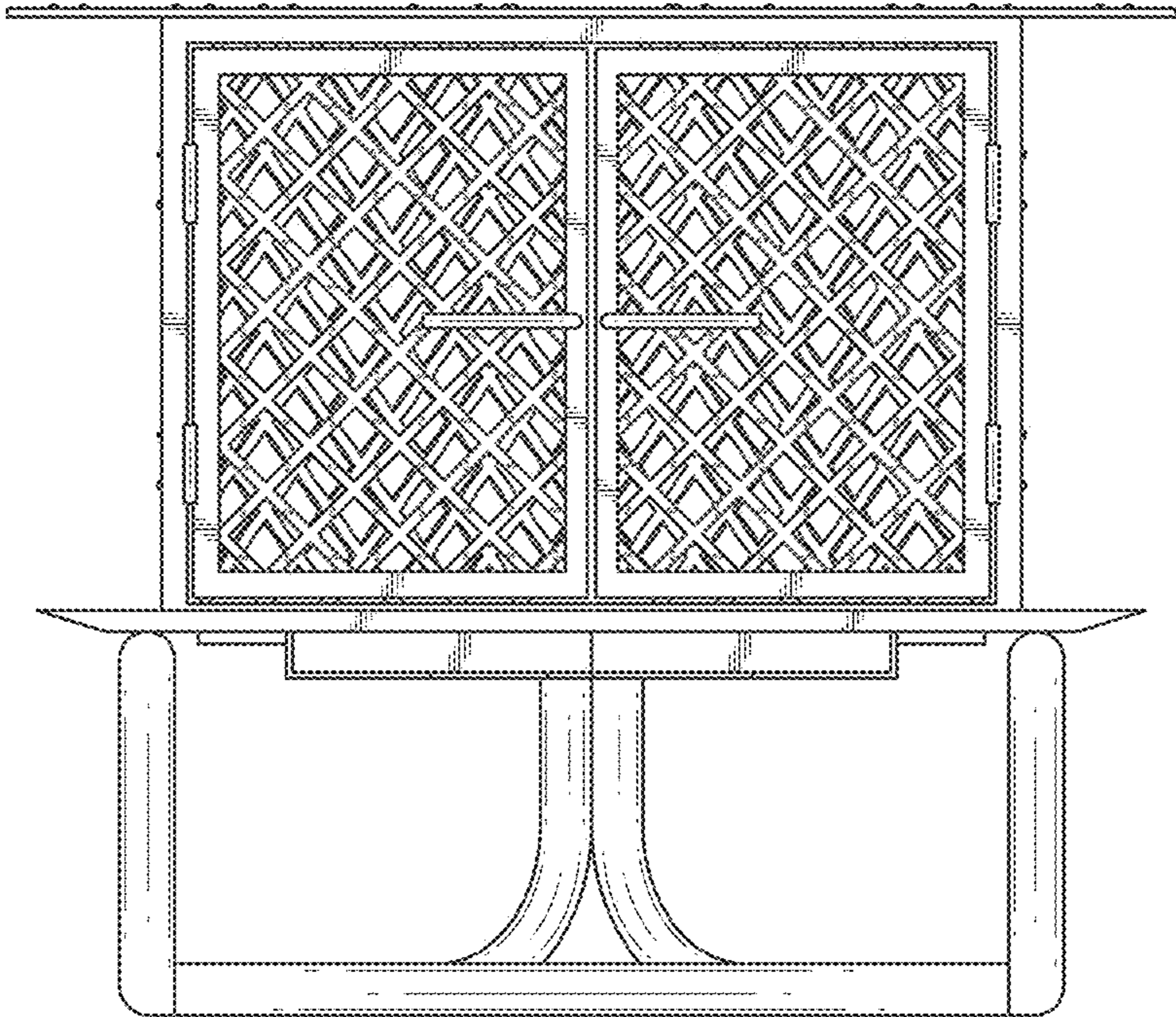

FIG. 2

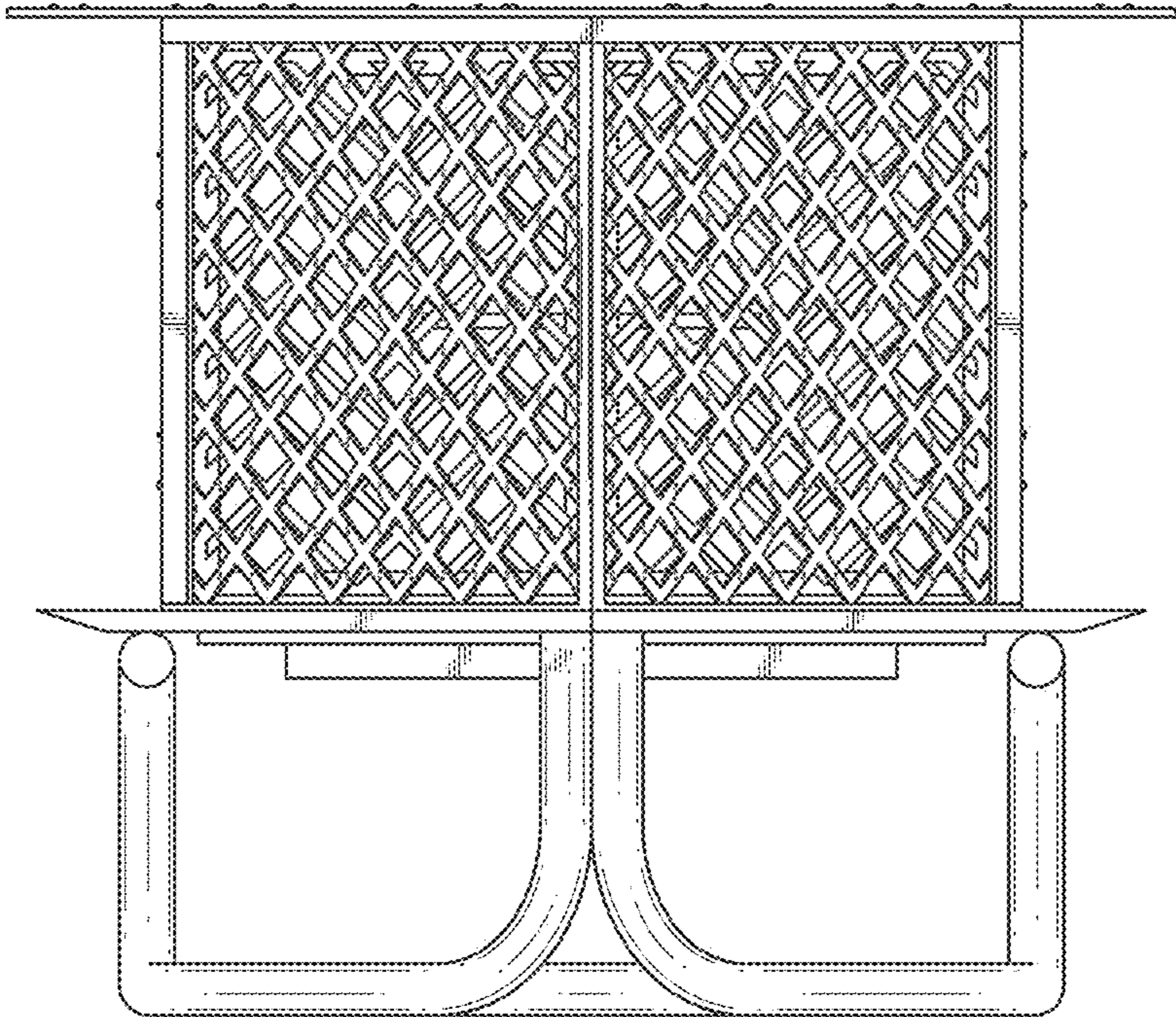

FIG. 3

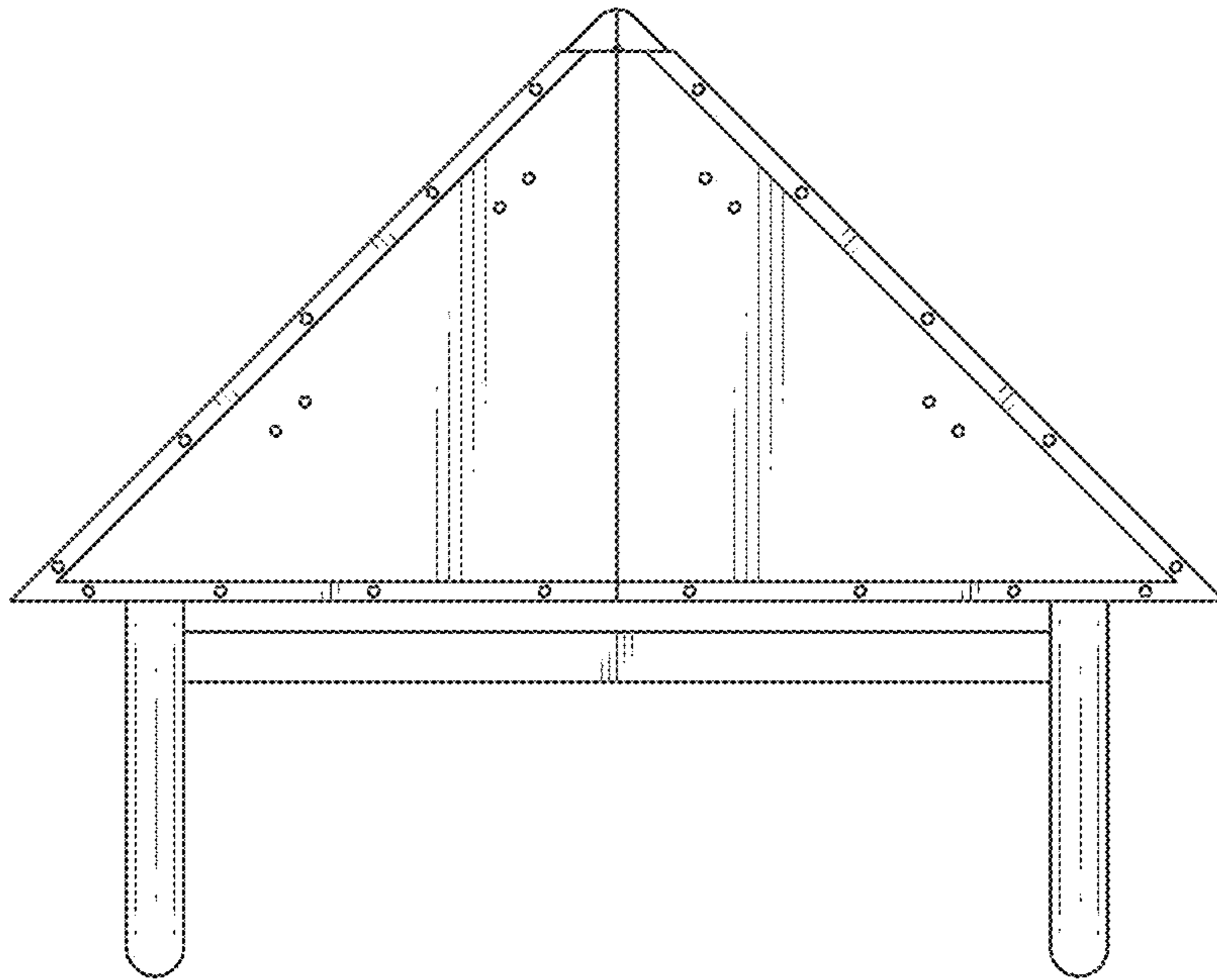

FIG. 4

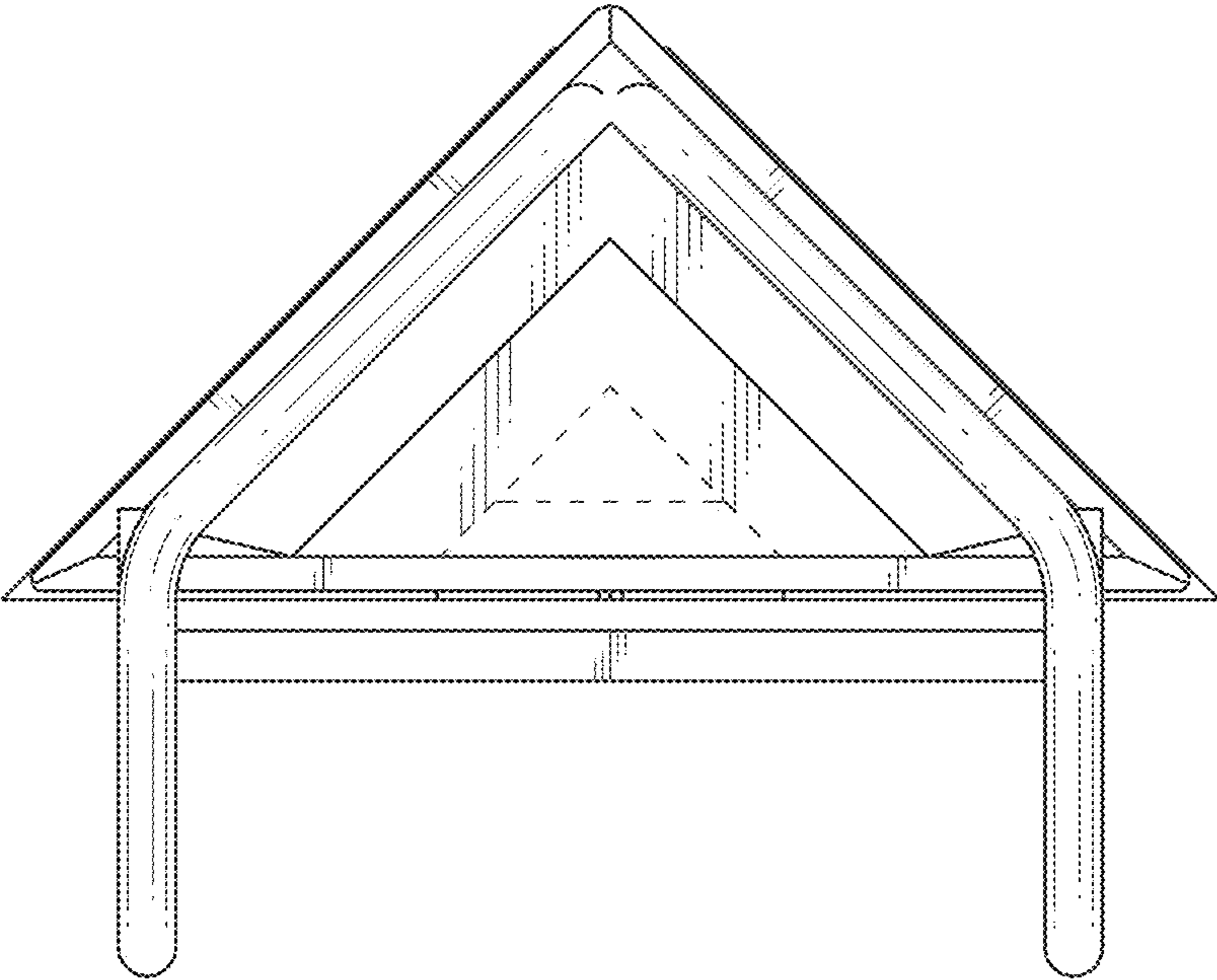

FIG. 5

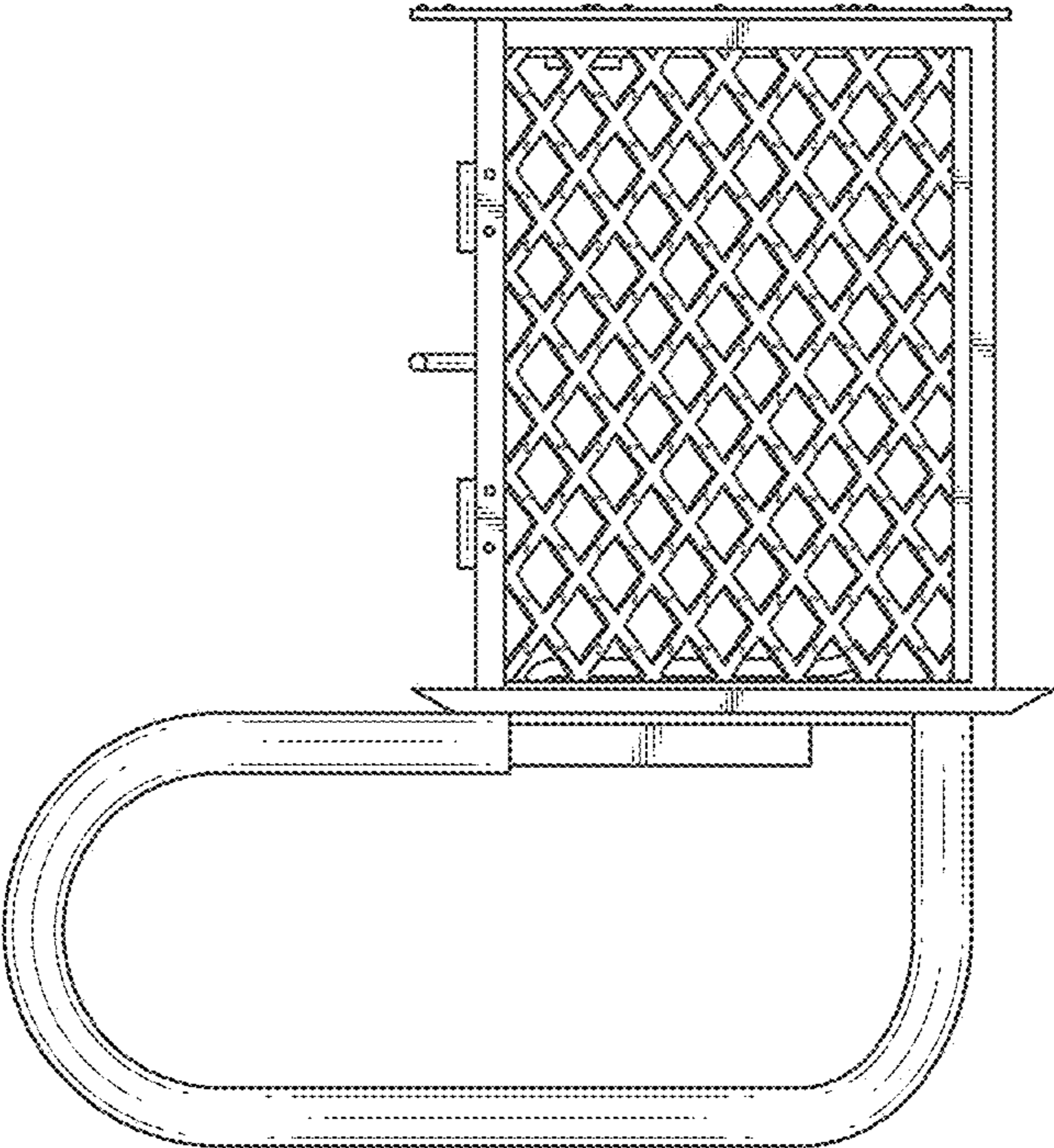

FIG. 6

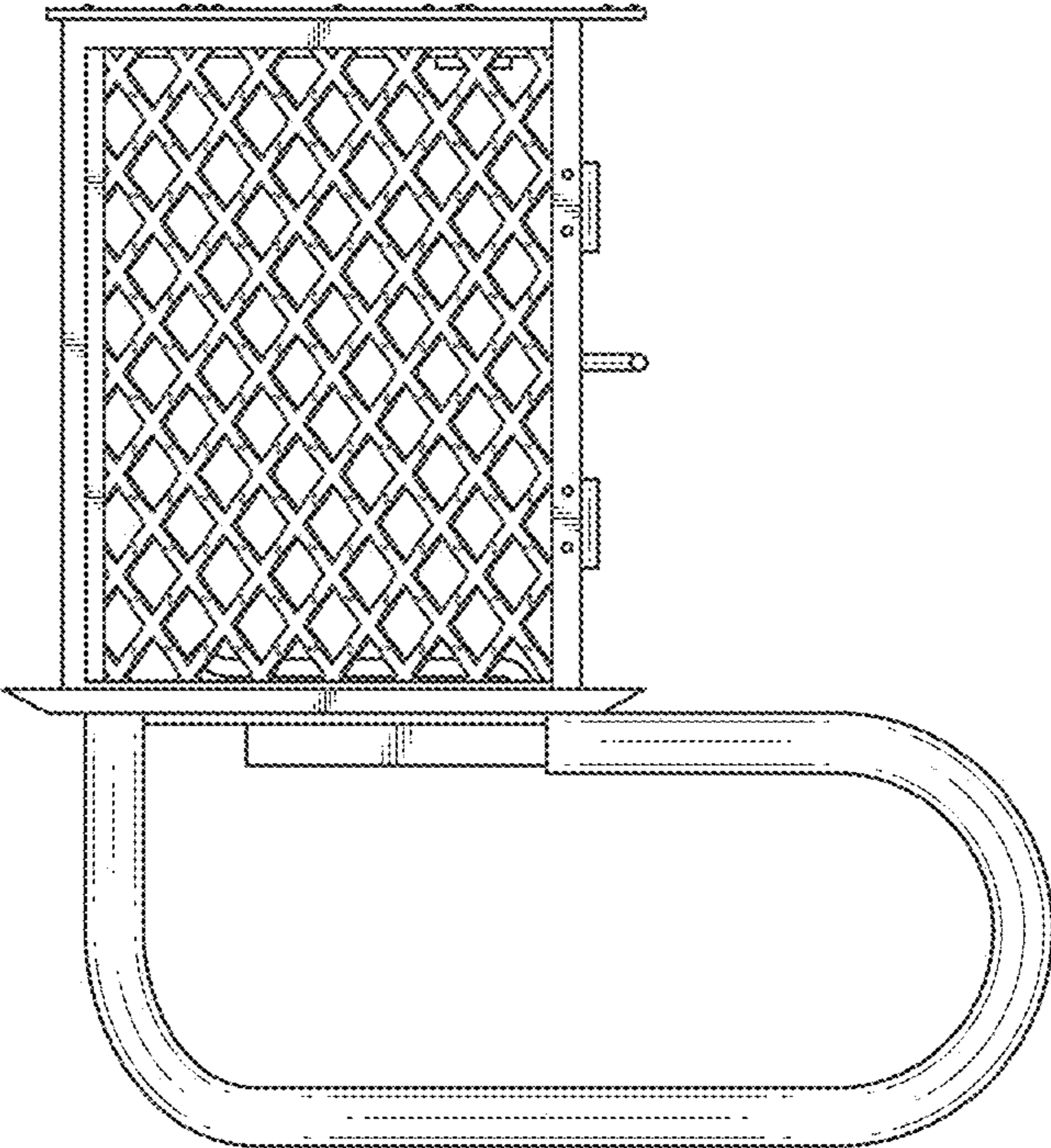

FIG. 7



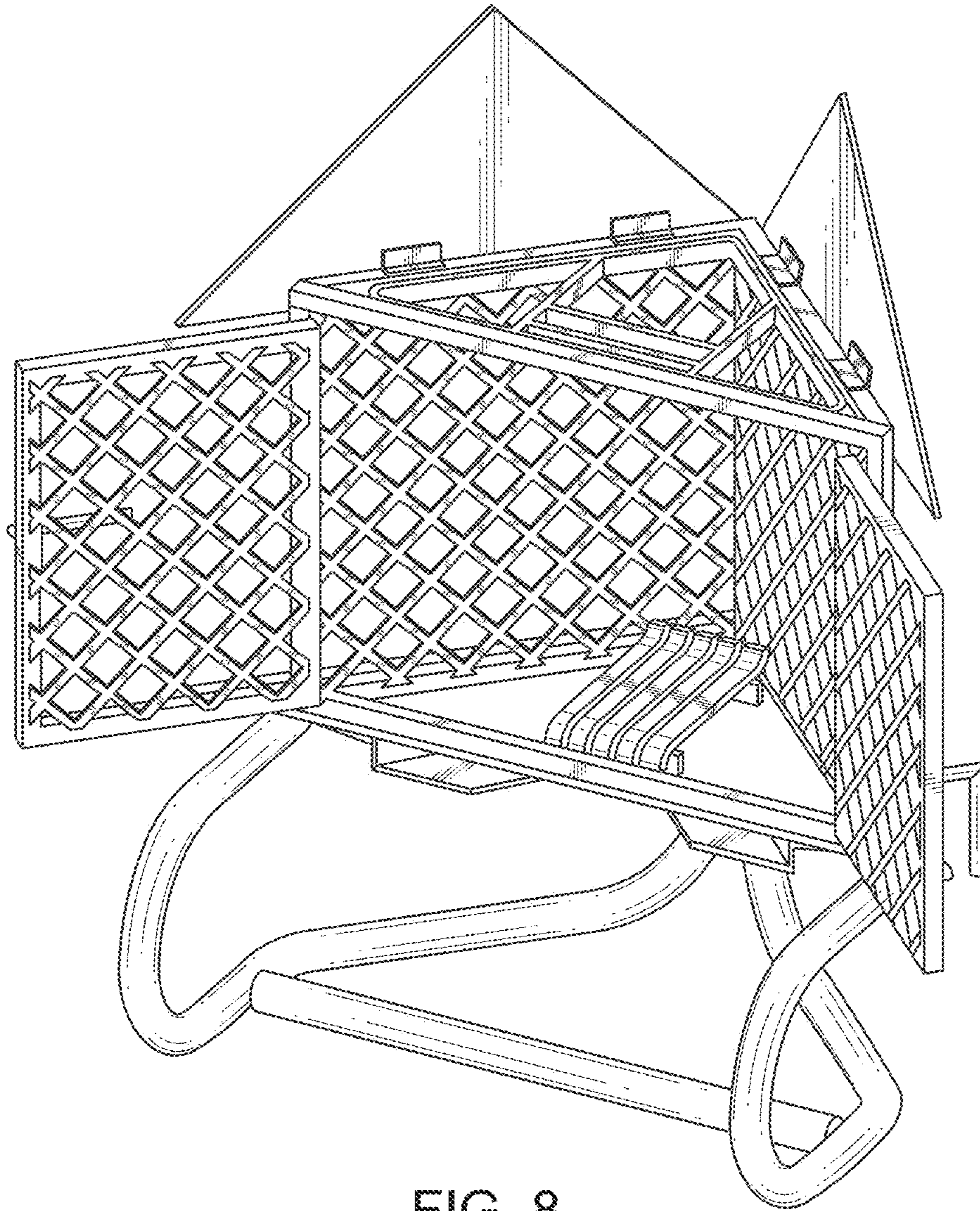

FIG. 8

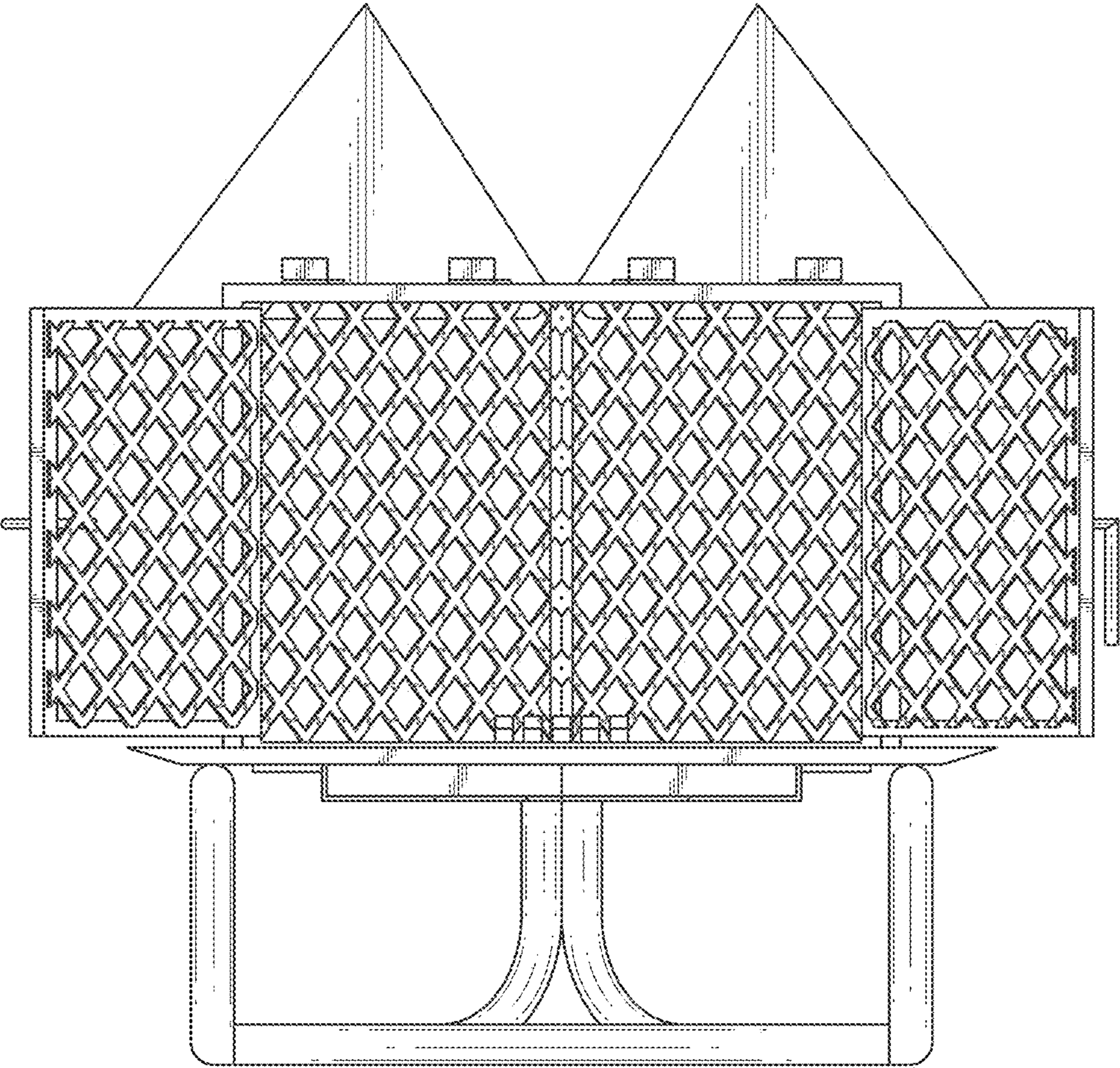

FIG. 9

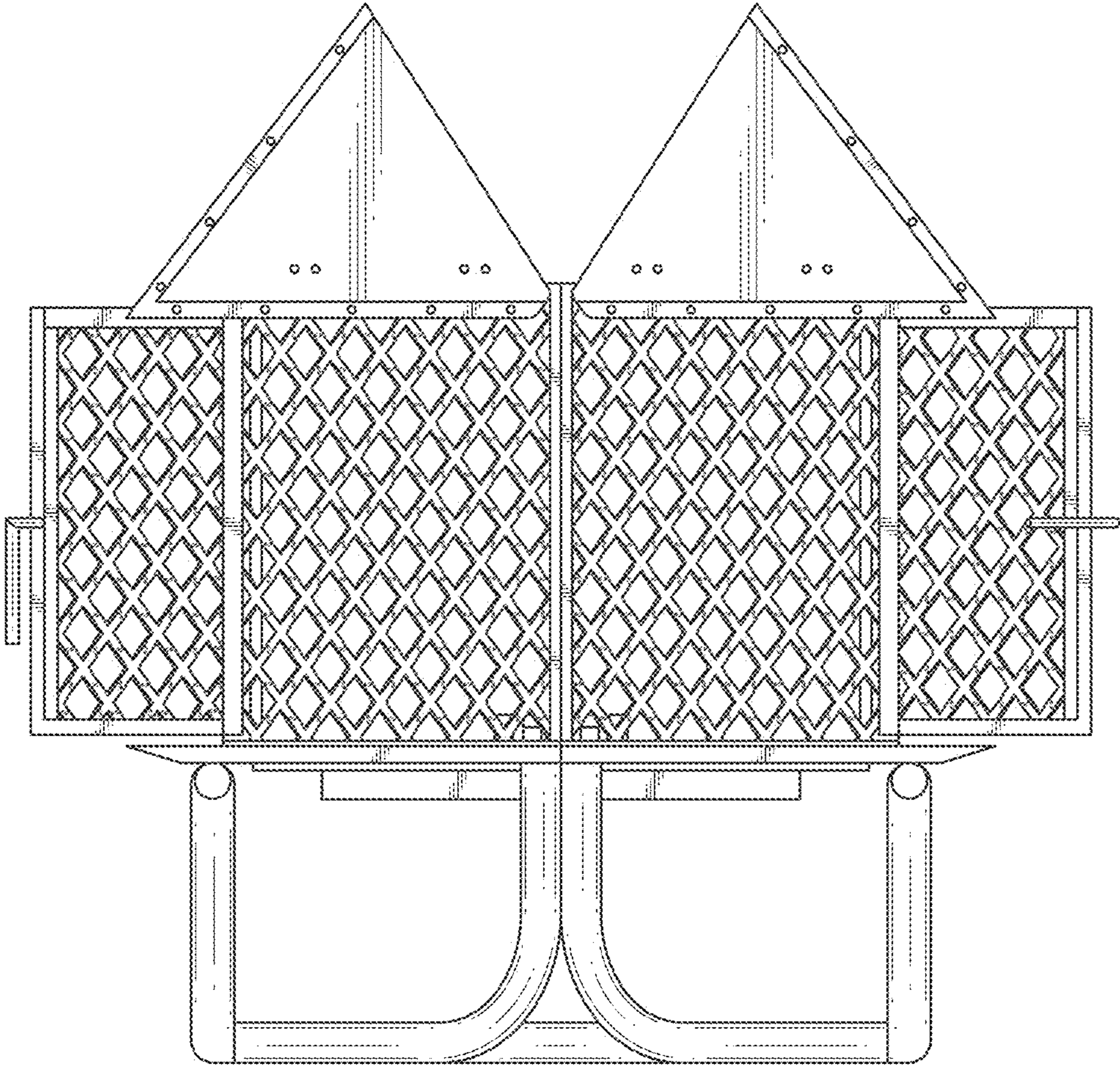

FIG. 10

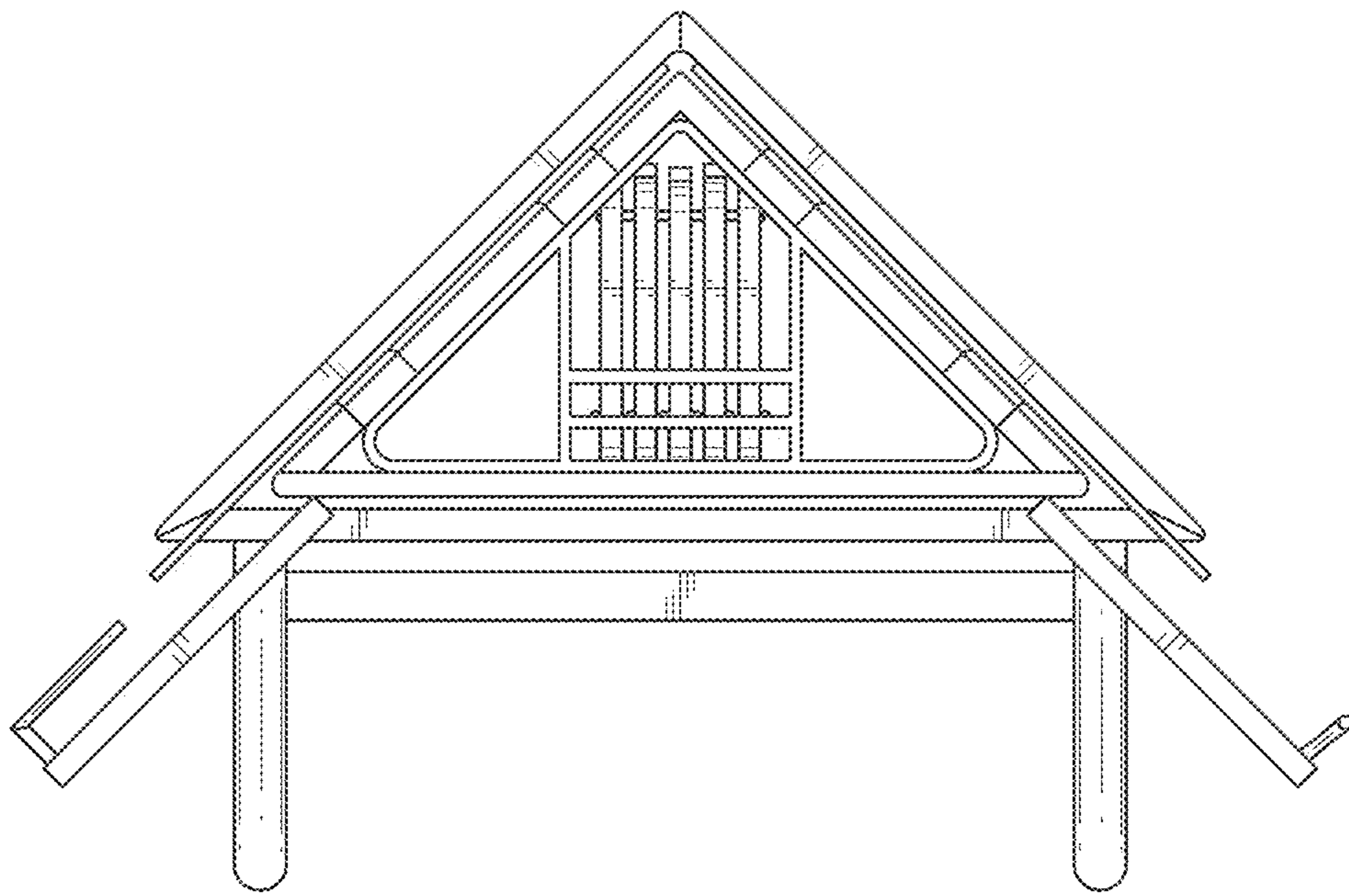

FIG. 11

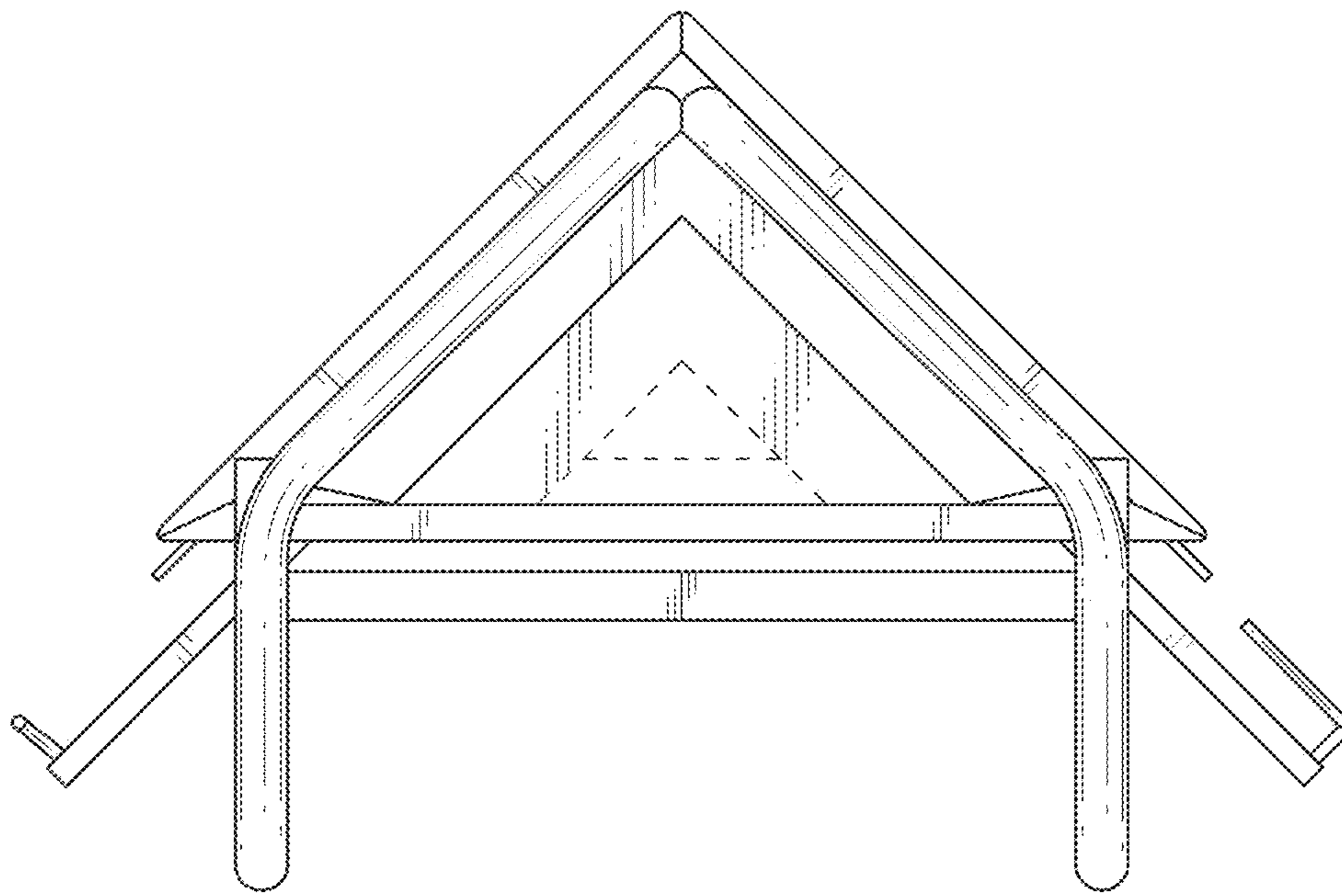

FIG. 12

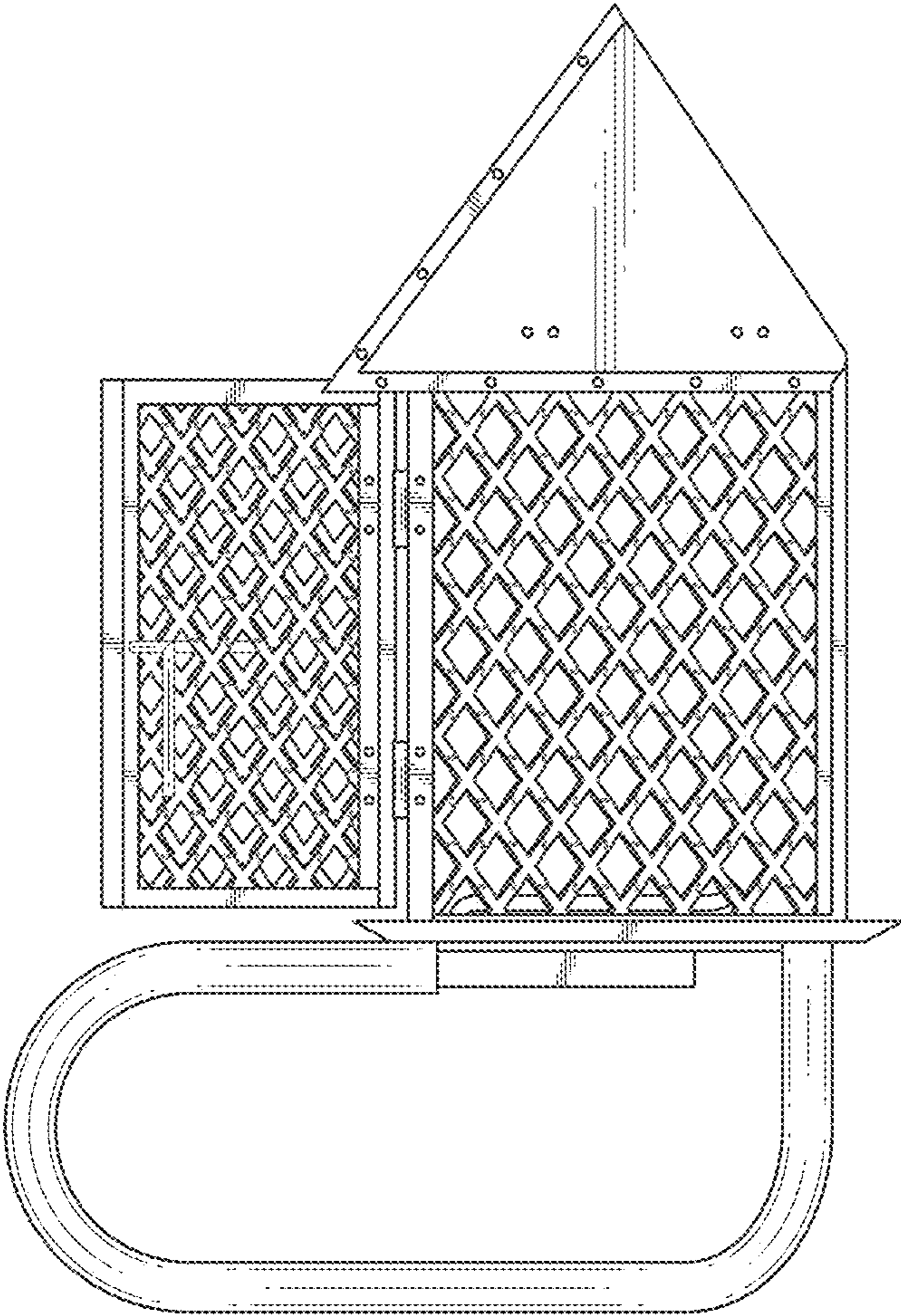

FIG. 13

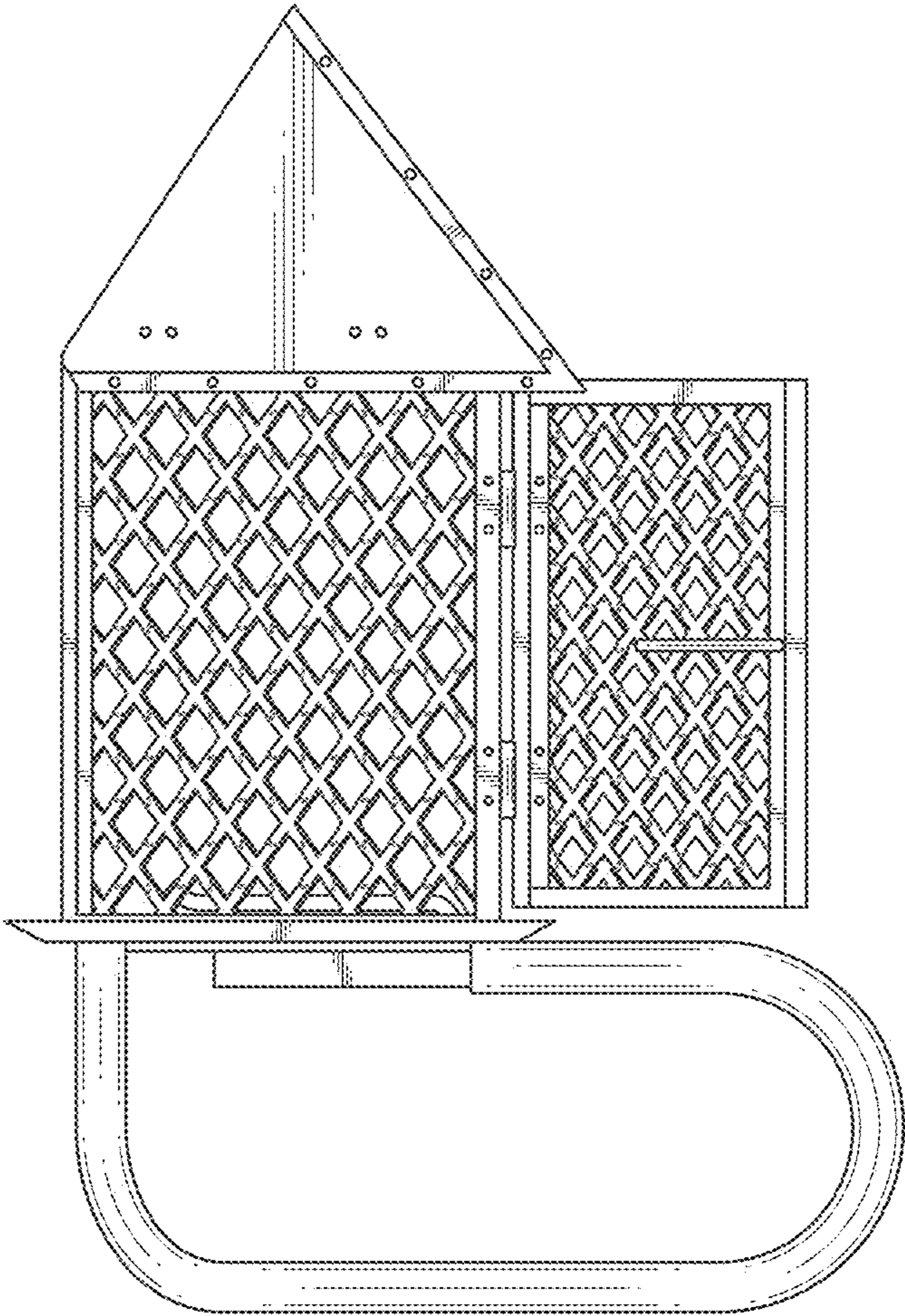

FIG. 14