



US00D952738S

(12) **United States Design Patent** (10) **Patent No.:** **US D952,738 S**
Mills et al. (45) **Date of Patent:** **** May 24, 2022**

(54) **PAYMENT CARD** 2033/10; B42D 2033/16; B42D 2033/18;
B42D 2033/20; B42D 2033/28; B42D
2033/30

(71) Applicant: **Capital One Services, LLC**, McLean,
VA (US)

See application file for complete search history.

(72) Inventors: **Brian R. Mills**, Richmond, VA (US);
Carl Pierce, Philadelphia, PA (US)

(56) **References Cited**

(73) Assignee: **Capital One Services, LLC**, McLean,
VA (US)

U.S. PATENT DOCUMENTS

(**) Term: **15 Years**

D466,929 S	12/2002	Haas
D480,754 S	10/2003	Berger
D490,103 S	5/2004	Rangel et al.
D510,384 S	10/2005	Allen et al.
D559,905 S	1/2008	Halbur et al.
D568,388 S	5/2008	Hammad

(21) Appl. No.: **29/749,852**

(Continued)

(22) Filed: **Sep. 9, 2020**

Primary Examiner — Abraham Bahta

Related U.S. Application Data

(74) *Attorney, Agent, or Firm* — Finnegan, Henderson,
Farabow, Garrett & Dunner, LLP

(62) Division of application No. 29/709,720, filed on Oct.
16, 2019, now Pat. No. Des. 898,822, which is a
division of application No. 29/692,453, filed on May
24, 2019, now Pat. No. Des. 868,887, which is a
division of application No. 29/677,787, filed on Jan.
23, 2019, now Pat. No. Des. 857,093, which is a
division of application No. 29/596,806, filed on Mar.
10, 2017, now Pat. No. Des. 845,387.

(57) **CLAIM**

The ornamental design for a payment card, as shown and
described.

(51) **LOC (13) Cl.** **19-08**

(52) **U.S. Cl.**
USPC **D19/9**

(58) **Field of Classification Search**
USPC D19/1–10, 20–34; 40/124.01–124.15,
40/661, 776, 726; 283/72, 75–76,
283/105–107, 82, 70, 904, 74; 206/449;
D21/385; D20/10–11, 22, 27, 40, 42;
360/2; 235/380, 382
CPC B42D 15/00; B42D 15/022; B42D 15/027;
B42D 15/045; B42D 15/047; B42D
25/00; B42D 25/20; B42D 25/23; B42D
25/26; B42D 25/29; B42D 25/30; B42D
25/40; B42D 25/22; B42D 2033/02;
B42D 2033/04; B42D 2033/08; B42D

DESCRIPTION

FIG. 1 is a front right perspective view of a payment card
showing our new design;
FIG. 2 is a rear left perspective view thereof;
FIG. 3 is a front elevation view thereof;
FIG. 4 is a rear elevation view thereof;
FIG. 5 is a top plan view thereof, the bottom view being a
mirror image thereof;
FIG. 6 is a right side view thereof;
FIG. 7 is a left side view thereof; and,
FIG. 8 is an enlarged, detailed view of the top view, as
shown in FIG. 5.

The shape of the edge of the payment card illustrated in FIG.
8 is consistent around the perimeter of the top, right, left, and
bottom sides of the payment card in both embodiments. The
broken lines shown in the drawings illustrate portions of the
payment card that form no part of the claimed design.

1 Claim, 8 Drawing Sheets

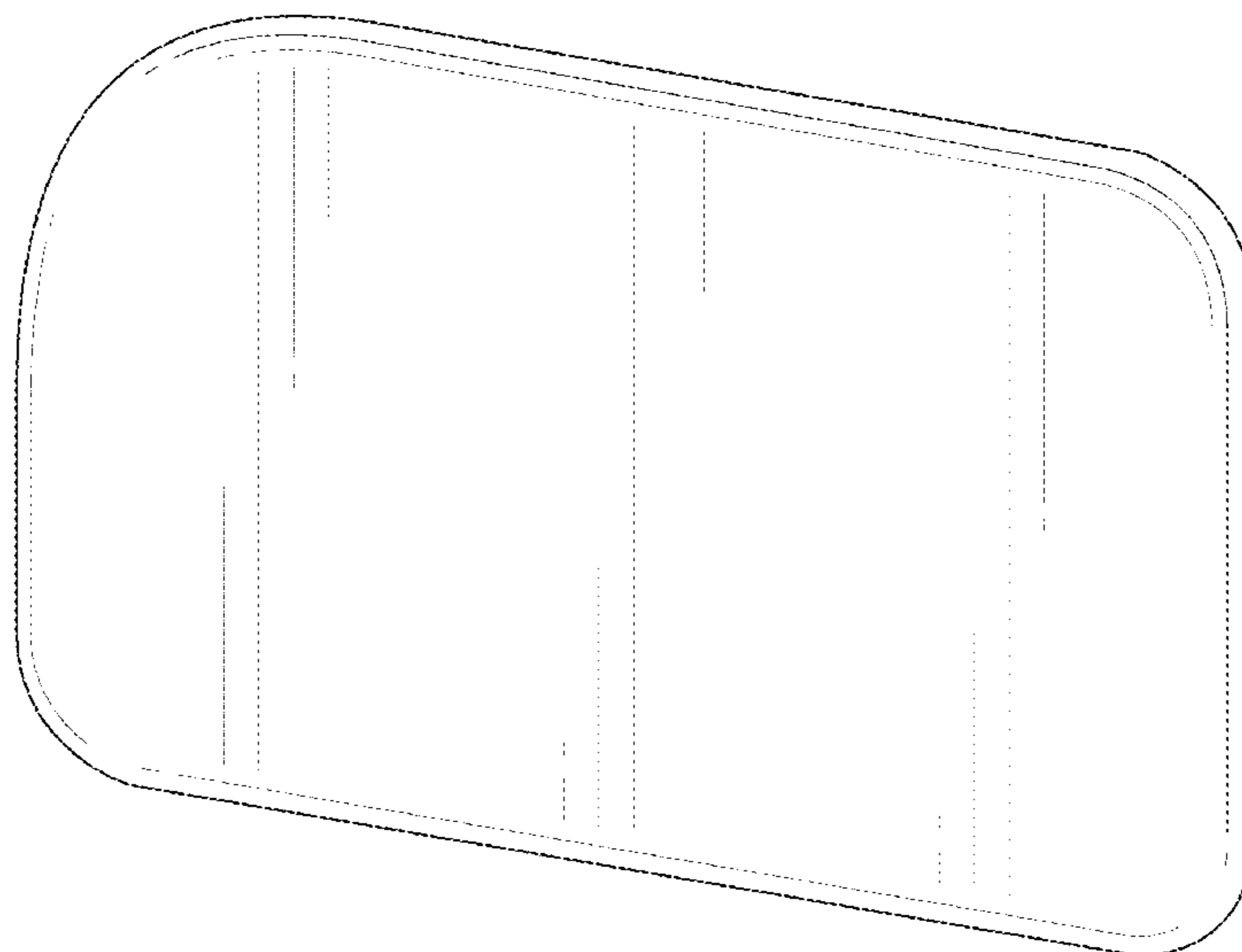

(56)

References Cited

U.S. PATENT DOCUMENTS

D569,425 S	5/2008	Law et al.	
D571,856 S	6/2008	Hammad et al.	
D575,332 S	8/2008	Parker et al.	
D599,849 S	9/2009	Halbur et al.	
D624,962 S	10/2010	Lazarowicz et al.	
D634,780 S	3/2011	Schumann	
D690,767 S	10/2013	Lindley	
D724,660 S	3/2015	Sippola et al.	
D779,591 S	2/2017	Cepress	
D803,313 S	11/2017	Cepress	
D847,256 S	4/2019	Mills et al.	
D857,093 S	8/2019	Mills et al.	
D858,629 S	9/2019	Cepress	
D866,660 S *	11/2019	Mills	D19/9
D868,887 S	12/2019	Mills et al.	
D896,887 S *	9/2020	Herrington	D19/9
D933,125 S *	10/2021	Mills	D19/9
D933,127 S *	10/2021	Cepress	D19/10

* cited by examiner



FIG. 1

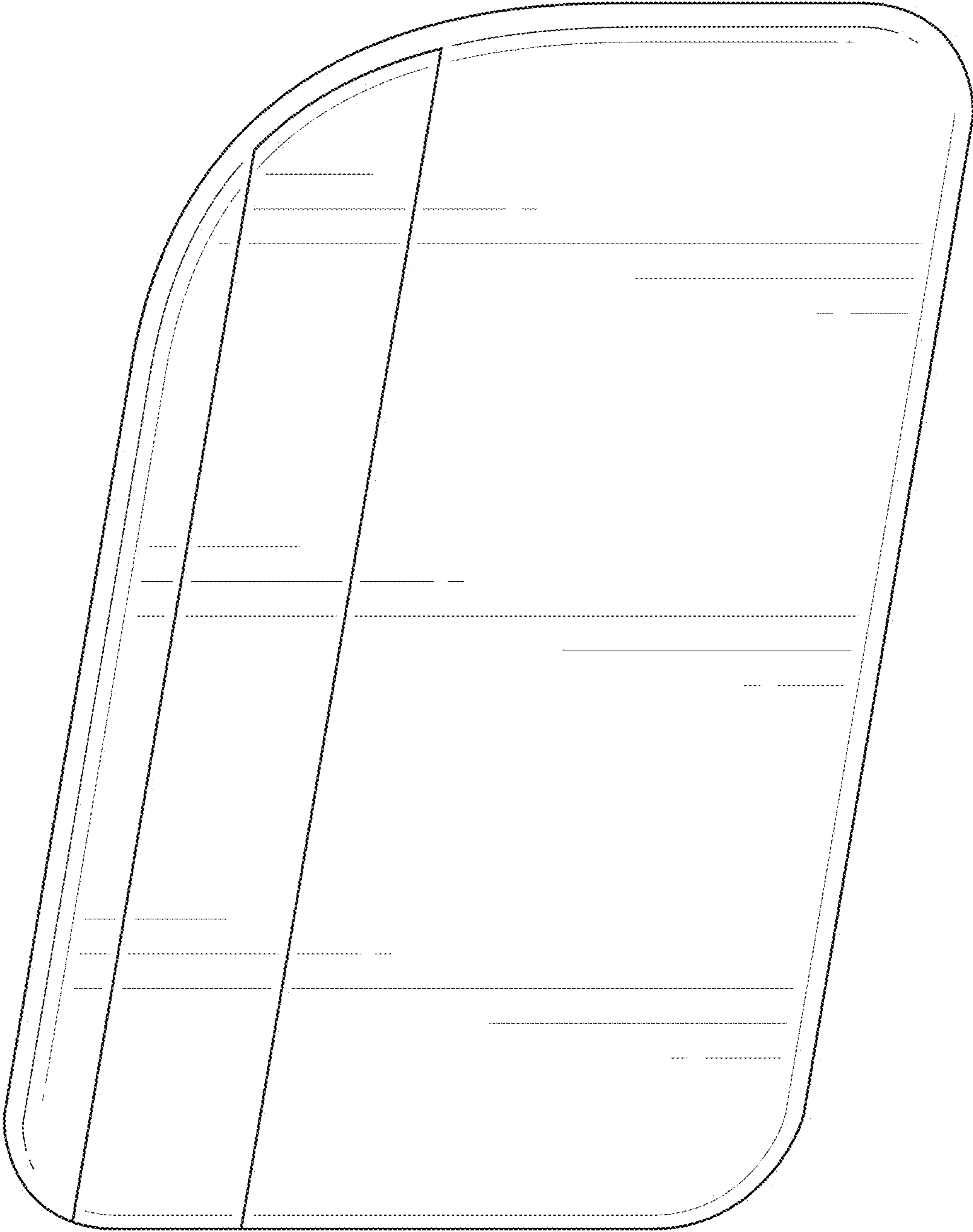

FIG. 2

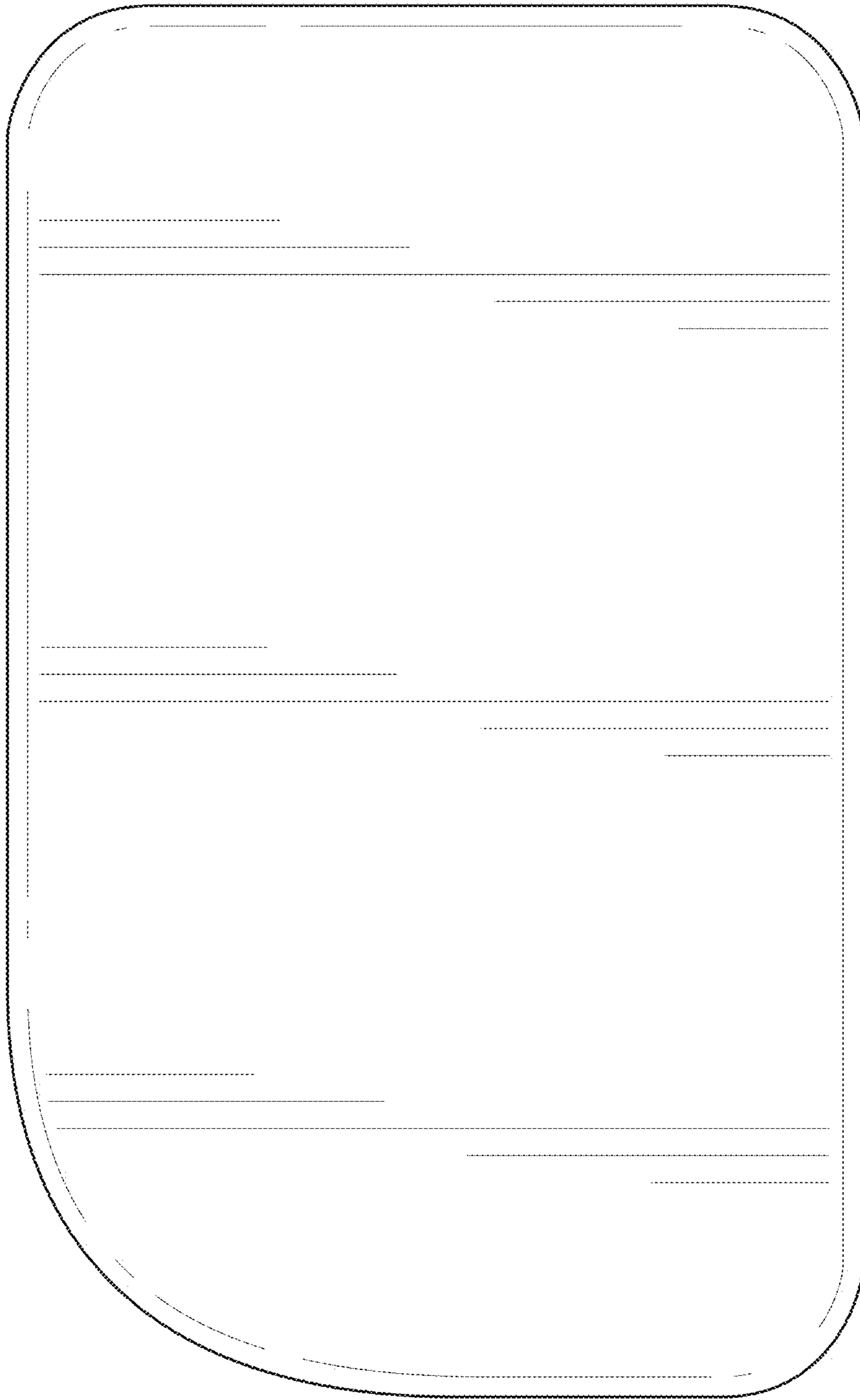

FIG. 3

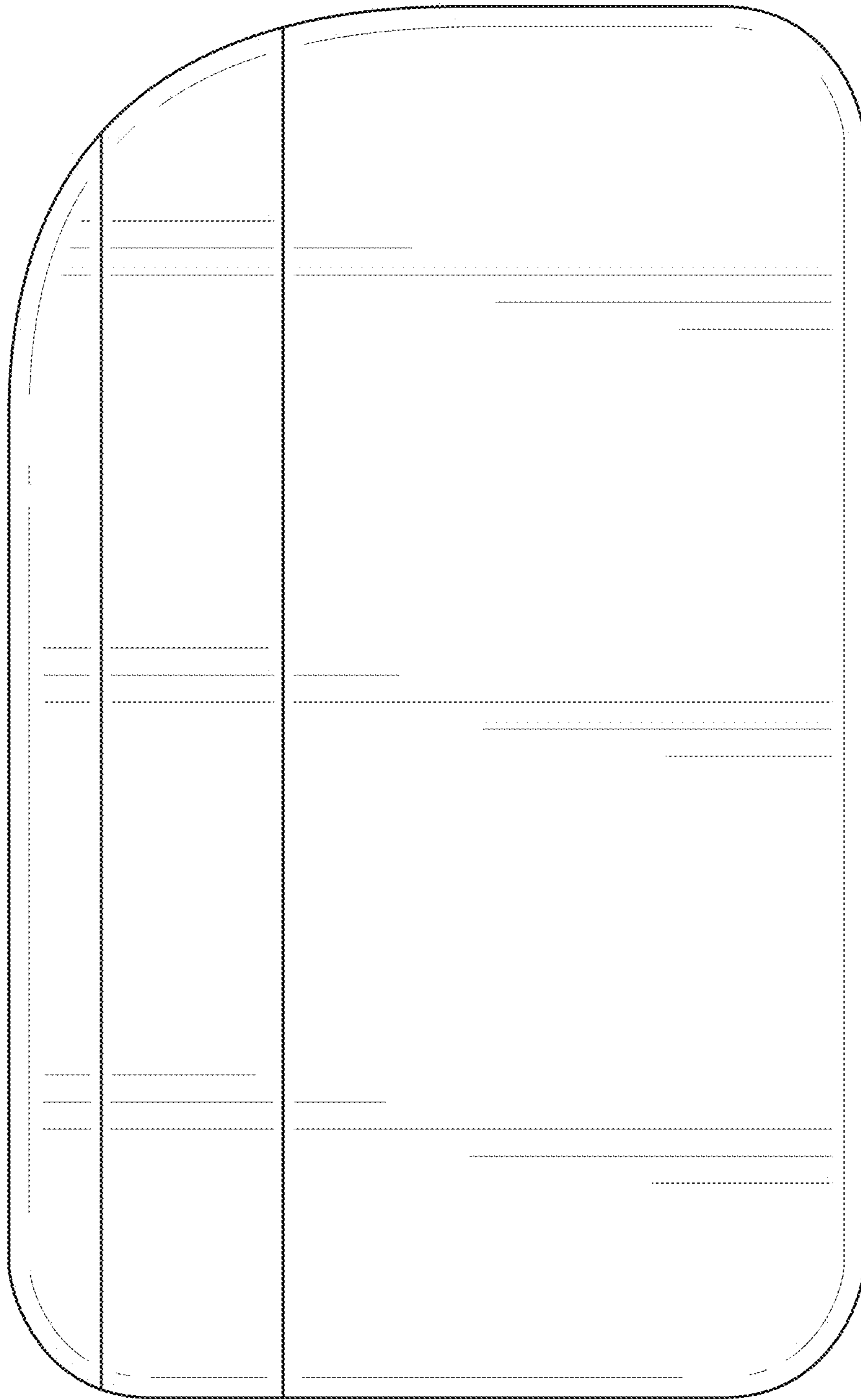

FIG. 4

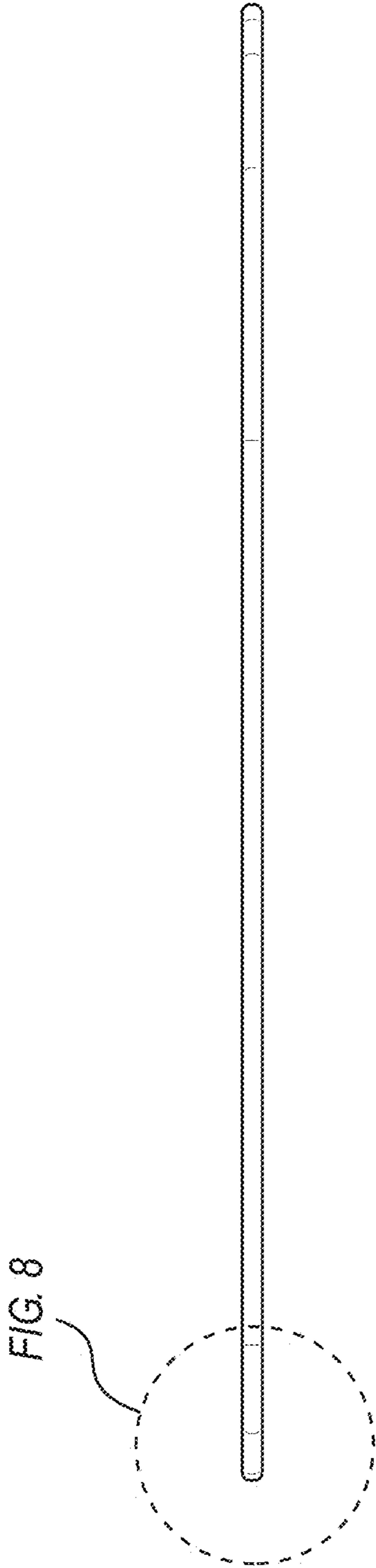

FIG. 5

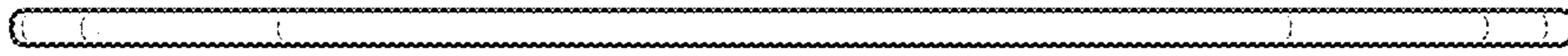

FIG. 6

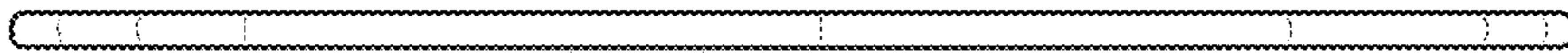

FIG. 7

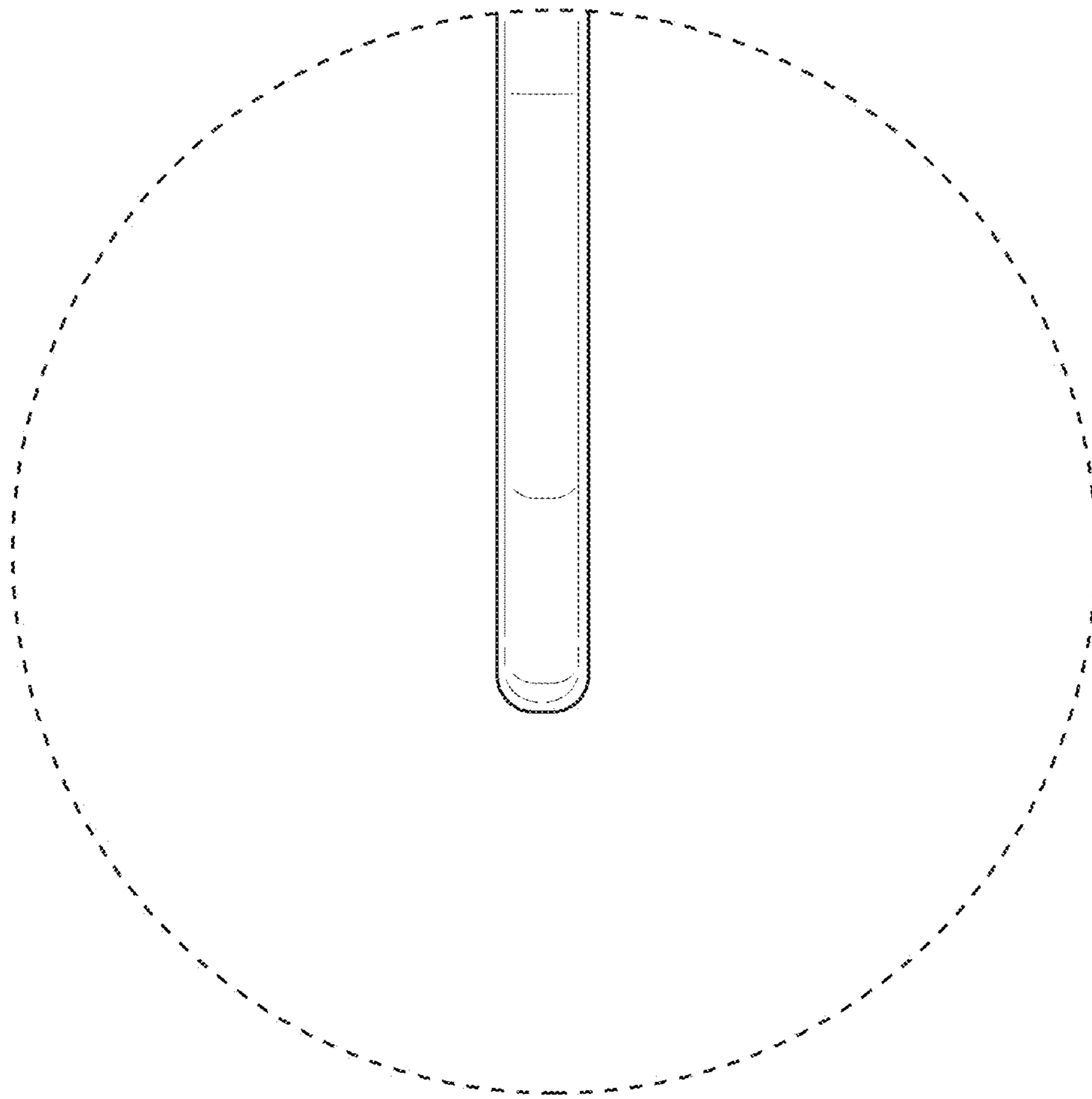

FIG. 8