



US00D952719S

(12) **United States Design Patent** (10) **Patent No.:** **US D952,719 S**  
**Dubrovsky** (45) **Date of Patent:** **\*\* May 24, 2022**

(54) **COVER FOR A PROGRAMMABLE ROBOT**

(71) Applicant: **iRobot Corporation**, Bedford, MA (US)

(72) Inventor: **Zivthan A. C. Dubrovsky**, Lexington, MA (US)

(73) Assignee: **iRobot Corporation**, Bedford, MA (US)

(\*\*) Term: **15 Years**

(21) Appl. No.: **29/737,623**

(22) Filed: **Jun. 10, 2020**

(51) **LOC (13) Cl.** ..... **15-99**

(52) **U.S. Cl.**  
USPC ..... **D15/199**

(58) **Field of Classification Search**  
USPC .... D15/199; D32/17, 18, 21, 22, 23, 24, 25, D32/31, 32, 33, 34  
CPC ..... A47L 5/24; A47L 5/28; A47L 5/30; A47L 7/02; A47L 7/0085; A47L 9/00; A47L 11/00; A47L 11/20; A47L 11/34; A47L 11/40; A47L 11/4016; A47L 2201/00

See application file for complete search history.

(56) **References Cited**

**U.S. PATENT DOCUMENTS**

- D661,440 S \* 6/2012 Lee ..... D32/21
- D669,235 S \* 10/2012 Bassett ..... D32/21
- 8,881,339 B2 \* 11/2014 Gilbert, Jr. .... A47L 11/24  
15/319
- 9,078,552 B2 \* 7/2015 Han ..... A47L 11/4036
- 9,125,539 B2 \* 9/2015 Kim ..... G05D 1/0274
- D771,884 S \* 11/2016 Ninomiya ..... D32/21
- 9,757,004 B2 \* 9/2017 Neumann ..... A47L 9/2889
- D835,869 S \* 12/2018 Li ..... D32/21
- D840,617 S \* 2/2019 Dou ..... D32/21
- D869,109 S \* 12/2019 Yu ..... D32/21

- D870,403 S \* 12/2019 Ebrahimi Afrouzi ..... D32/21
- D871,693 S \* 12/2019 Ebrahimi Afrouzi ..... D32/21
- D872,953 S \* 1/2020 Ebrahimi Afrouzi ..... D32/21
- D885,698 S \* 5/2020 Li ..... D32/21
- D890,457 S \* 7/2020 Pearce ..... D32/21
- D902,507 S \* 11/2020 Ebrahimi Afrouzi ..... D32/21
- 2015/0293533 A1 \* 10/2015 Ebrahimi Afrouzi .....  
G05D 1/0214  
701/2
- 2018/0103812 A1 \* 4/2018 Lee ..... A47L 9/0653

**OTHER PUBLICATIONS**

Weekly Maintenance—Bob PetHair Vision (on-line), dated Oct. 12, 2019. Retrieved from Internet Oct. 20, 2021, URL: <https://www.youtube.com/watch?v=gUT63ZHLRI8> (1 page) (Year: 2019) (Year: 2019).\*

\* cited by examiner

*Primary Examiner* — Patricia A Palasik

(74) *Attorney, Agent, or Firm* — Schwegman Lundberg & Woessner, P.A.

(57) **CLAIM**

The ornamental design for a cover for a programmable robot, as shown and described.

**DESCRIPTION**

FIG. 1 is a top-left-isometric view of my cover for a programmable robot including a body in phantom; FIG. 2 is a front view thereof; FIG. 3 is a rear view thereof; FIG. 4 is a left-side view thereof; FIG. 5 is a right-side view thereof; FIG. 6 is a top view thereof; and, FIG. 7 is a bottom view thereof. The features shown in dashed lines represent unclaimed portions of the cover for a programmable robot and form no part of the claimed design.

**1 Claim, 5 Drawing Sheets**

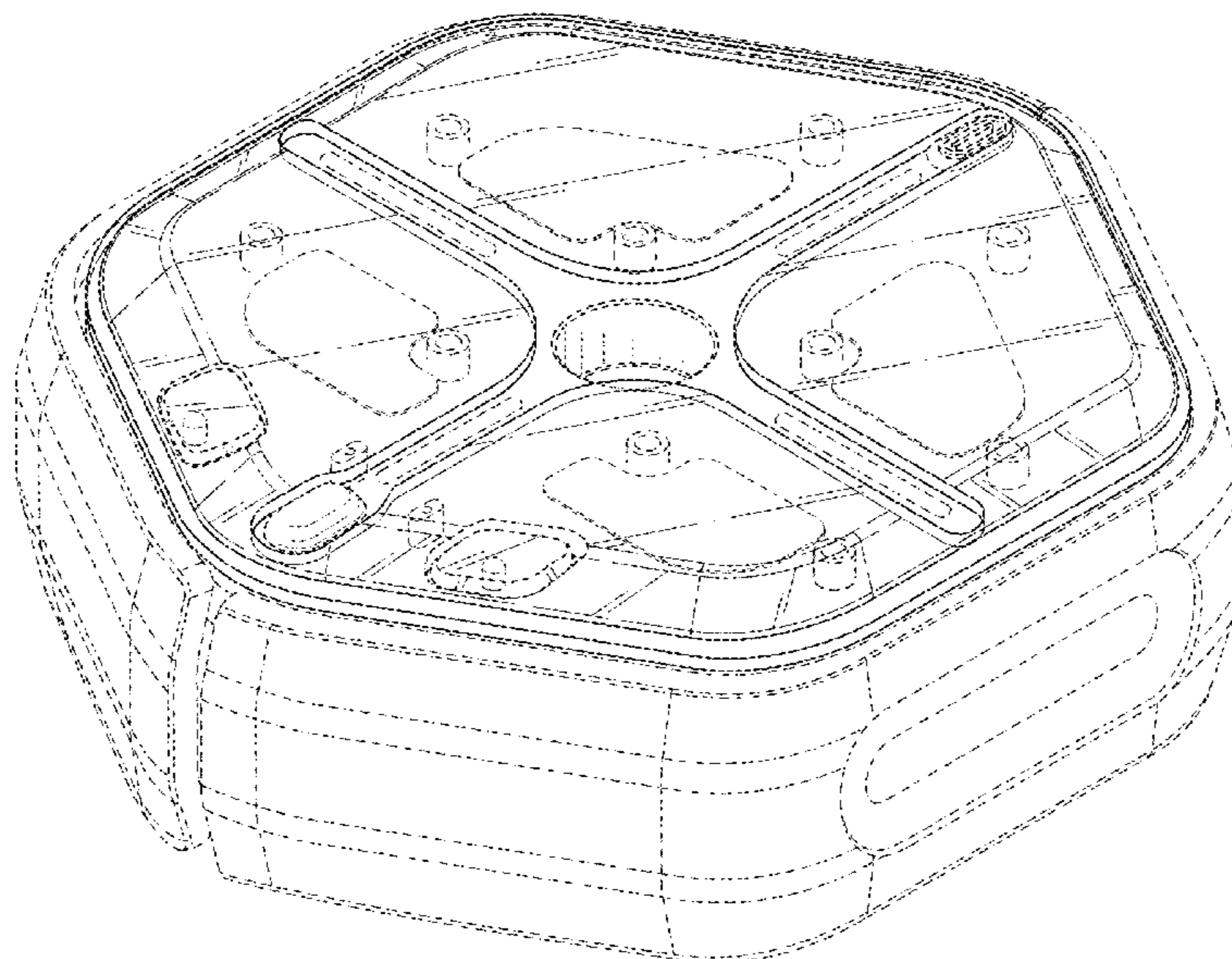

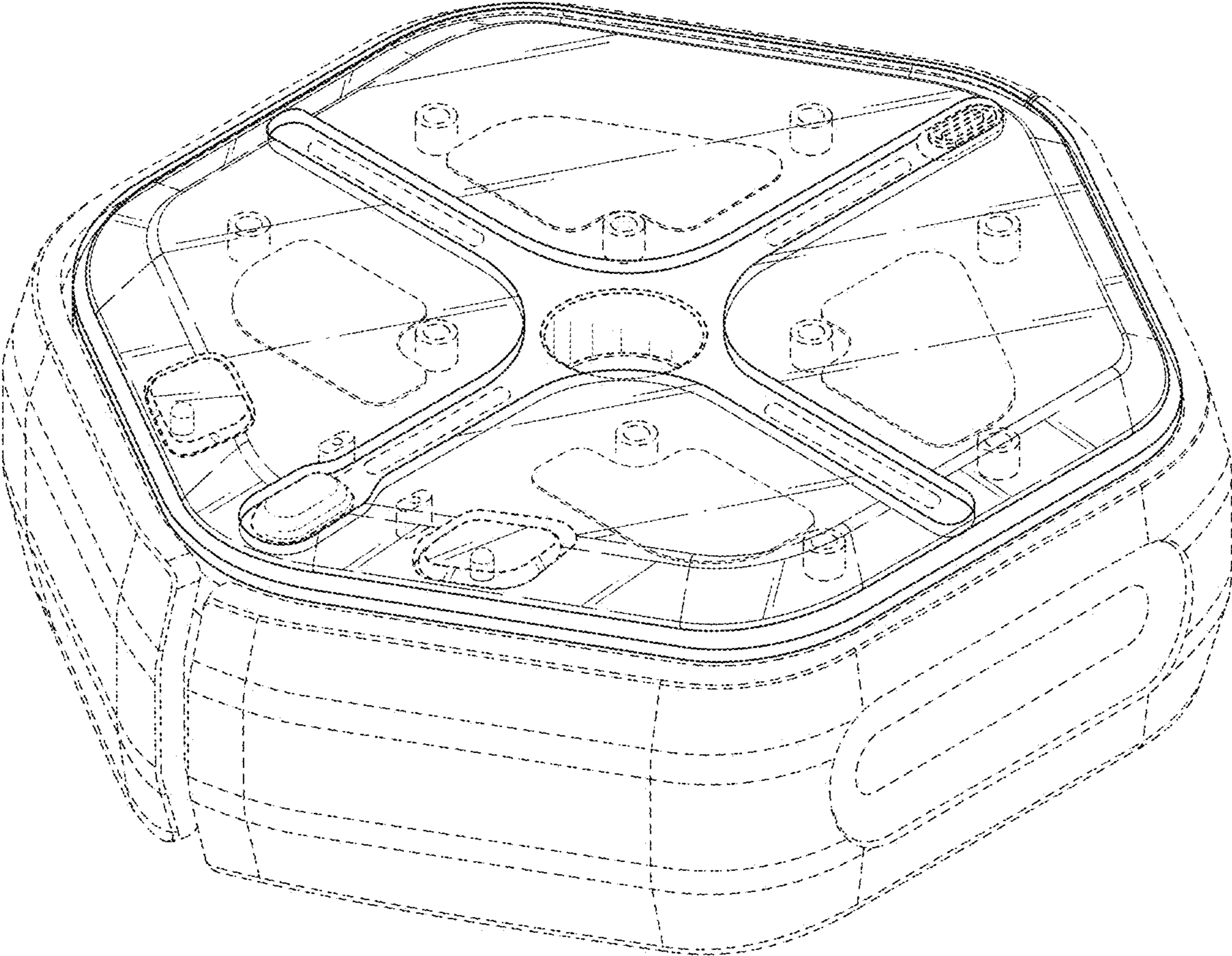

FIG. 1

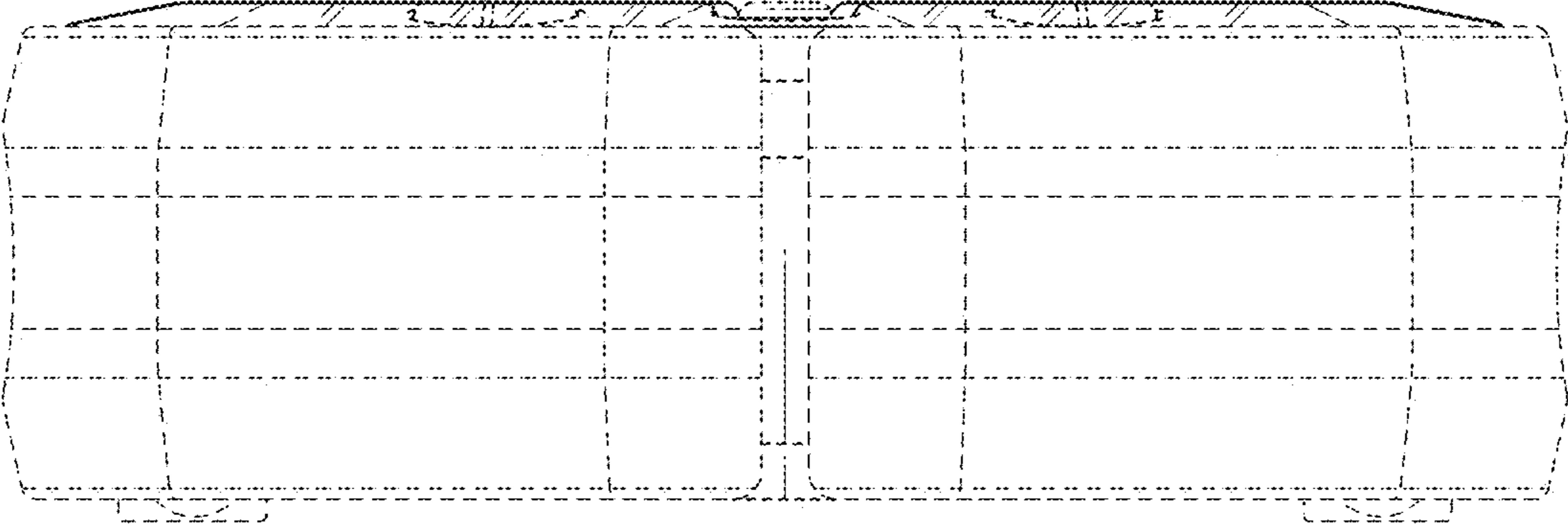

FIG. 2

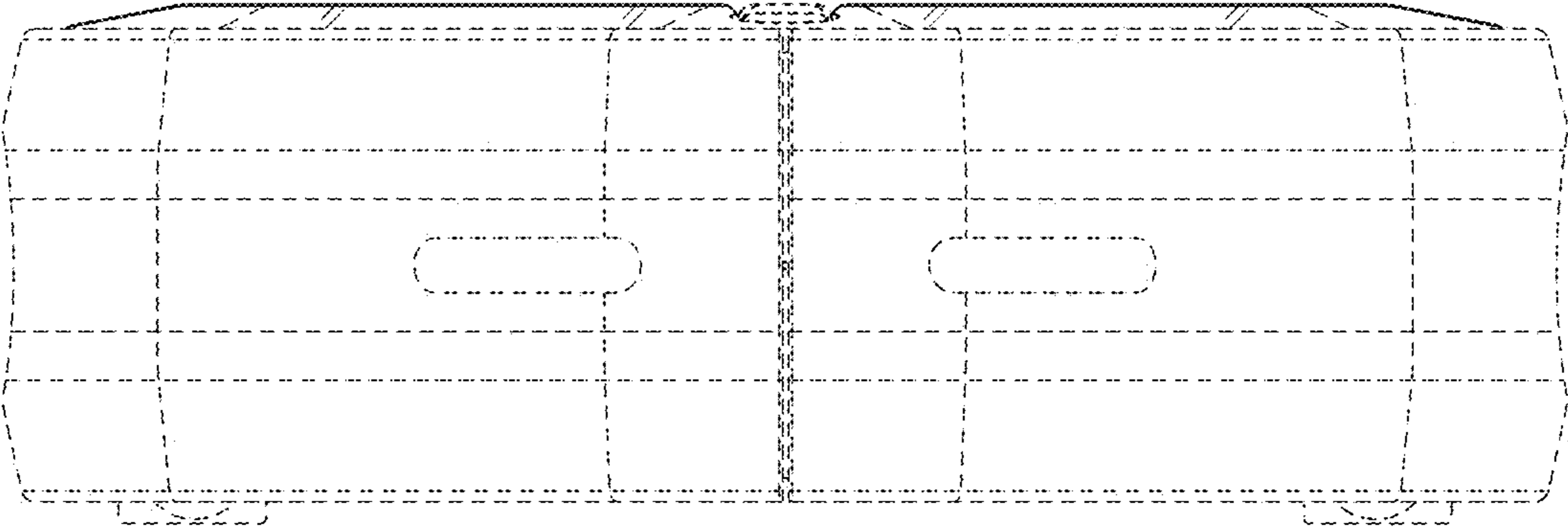

FIG. 3

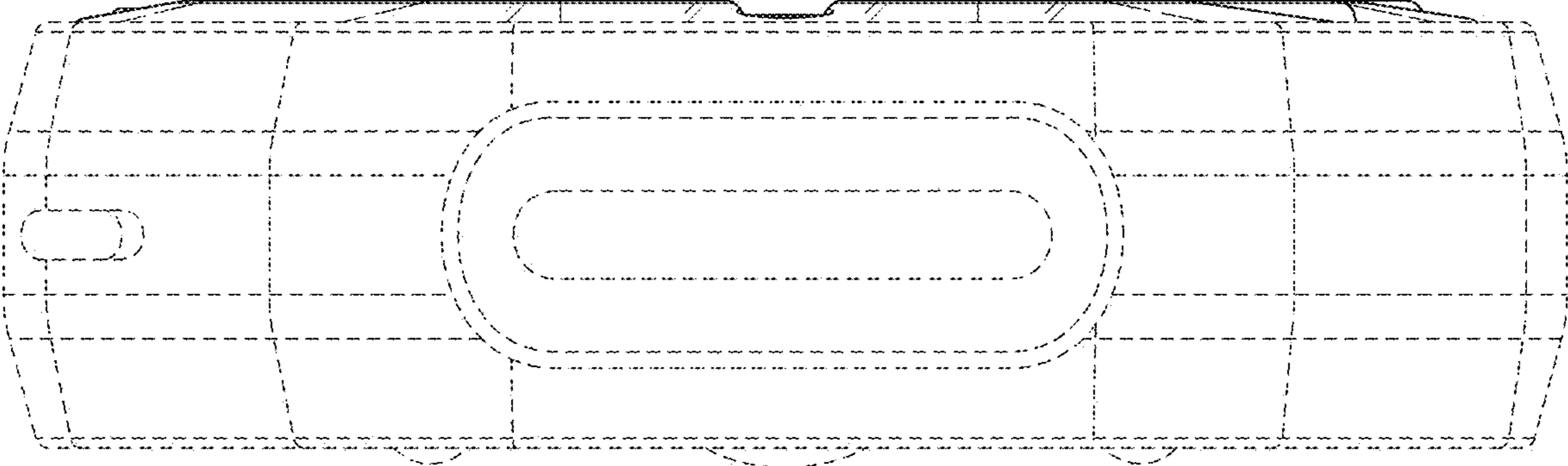

FIG. 4

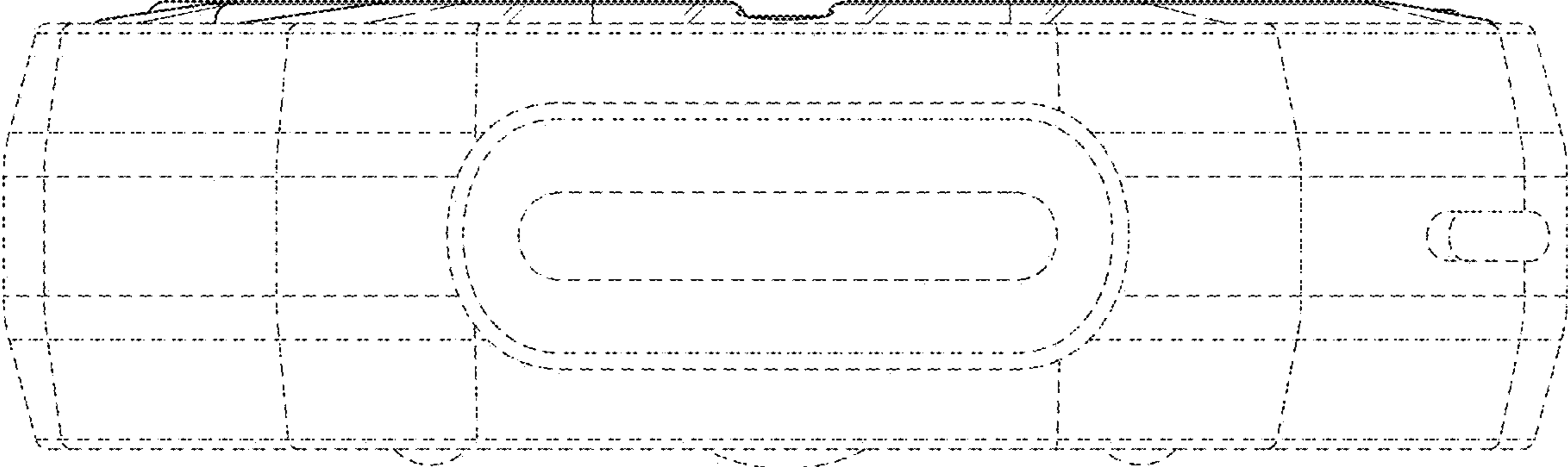

FIG. 5

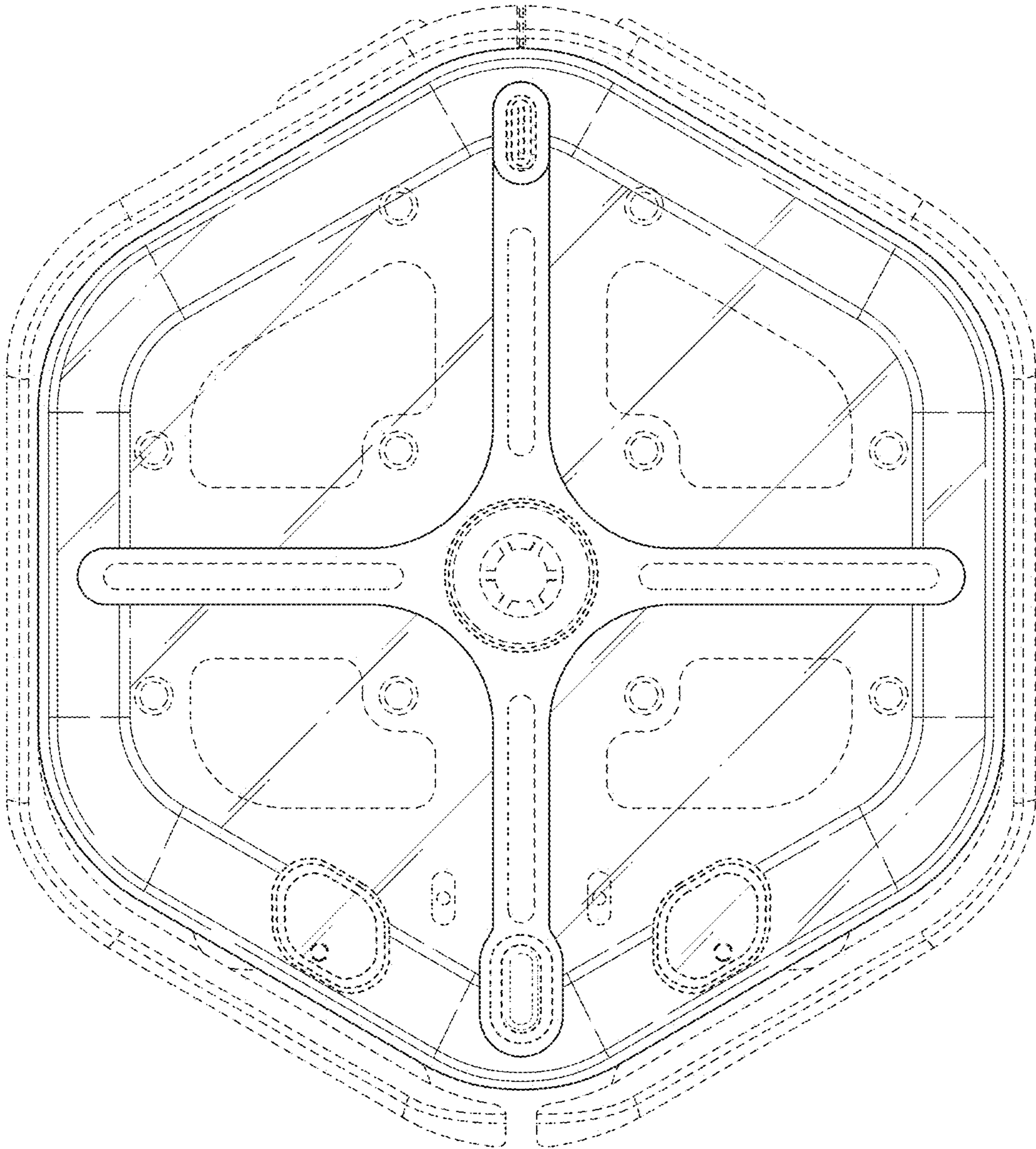

FIG. 6

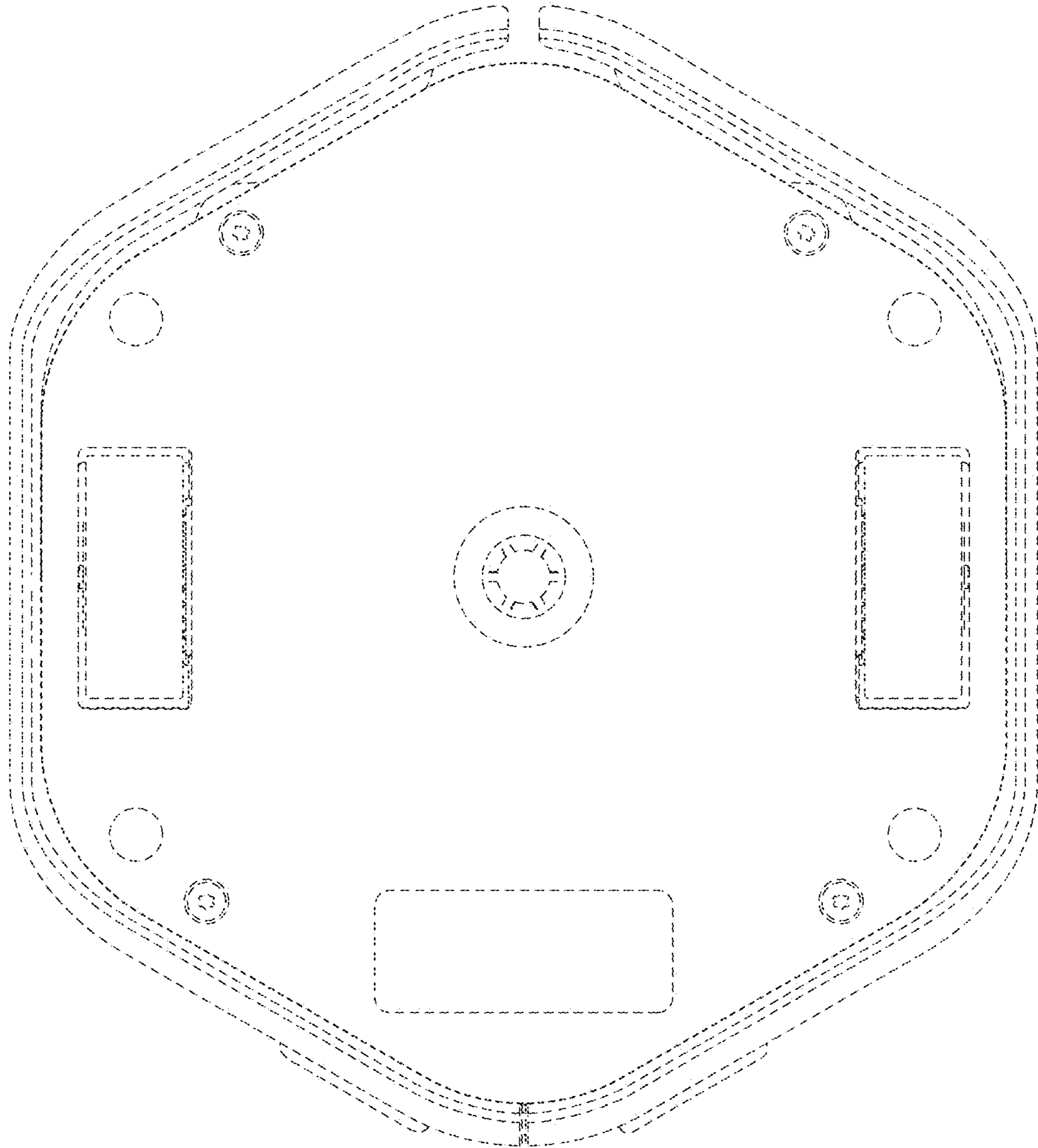

FIG. 7