



US00D952699S

(12) **United States Design Patent** (10) **Patent No.:** **US D952,699 S**  
**Li et al.** (45) **Date of Patent:** **\*\* May 24, 2022**

(54) **COSMETIC REFRIGERATOR**

FOREIGN PATENT DOCUMENTS

(71) Applicants: **Qi Li**, Zhejiang (CN); **Feng Zhou**, Zhejiang (CN); **Yun Zhang**, Zhejiang (CN)

CN 306532574 \* 5/2021  
GB 6108792 \* 12/2020

(Continued)

(72) Inventors: **Qi Li**, Zhejiang (CN); **Feng Zhou**, Zhejiang (CN); **Yun Zhang**, Zhejiang (CN)

OTHER PUBLICATIONS

(73) Assignees: **Hangzhou PINKTOP Intelligent Technology Co., Ltd**, Zhejiang (CN); **Hangzhou R&D design CO., LTD**, Zhejiang (CN)

FaceTory Strawberry Skincare Fridge [Online] URL: <https://www.amazon.com/FaceTory-Strawberry-Skincare-FridgeTemperature/dp/B08N5LB5FP> (full link in attached NPL; site visited Aug. 6, 2021) (Year: 2020).\*

(Continued)

(\*\*) Term: **15 Years**

*Primary Examiner* — Michael C Stout

*Assistant Examiner* — Tia Ruth-Renee Polidori

(21) Appl. No.: **29/732,945**

(57) **CLAIM**

The ornamental design for a cosmetic refrigerator, as shown and described.

(22) Filed: **Apr. 29, 2020**

(51) **LOC (13) Cl.** ..... **15-07**

(52) **U.S. Cl.**

USPC ..... **D15/79**; D15/81

(58) **Field of Classification Search**

USPC ..... D15/79-91; D3/201, 273, 294; 206/427, 206/486; 190/16, 19, 100, 109, 110

CPC ..... A47F 3/0408; A47F 7/00; A47F 3/0434; A47F 3/0486; A47F 3/001; A47F 3/0478; A47F 3/10; A47B 67/005; A47G 1/0622; A47G 206/427; A47G 206/486; A47G 190/16; A47G 190/19; A47G 190/10; A47G 190/109; A47G 190/11; F25D 17/065;

(Continued)

**DESCRIPTION**

FIG. 1 is a front, left and top perspective view of a cosmetic refrigerator showing our new design;

FIG. 2 is a rear, right and top perspective view thereof;

FIG. 3 is a front elevation view thereof;

FIG. 4 is a rear elevation view thereof;

FIG. 5 is a left side elevation view thereof;

FIG. 6 is a right side elevation view thereof;

FIG. 7 is a top plan view thereof;

FIG. 8 is a bottom plan view thereof;

FIG. 9 is an enlarged view of the cosmetic refrigerator taken from upper circle part in FIG. 5; and,

FIG. 10 is an enlarged view of the cosmetic refrigerator taken from lower circle part in FIG. 5.

The broken lines showing of the enlargement indicia in FIGS. 5, 9, and 10 is shown for the purpose of illustrating the bounds of the enlargement and forms no part of the claimed design.

The portions of the cosmetic refrigerator shown in broken lines form no part of the claimed design.

(56) **References Cited**

U.S. PATENT DOCUMENTS

D156,483 S \* 12/1949 Carrington ..... D15/88  
5,524,440 A \* 6/1996 Nishioka ..... A45C 15/00  
62/3.6

(Continued)

**1 Claim, 10 Drawing Sheets**

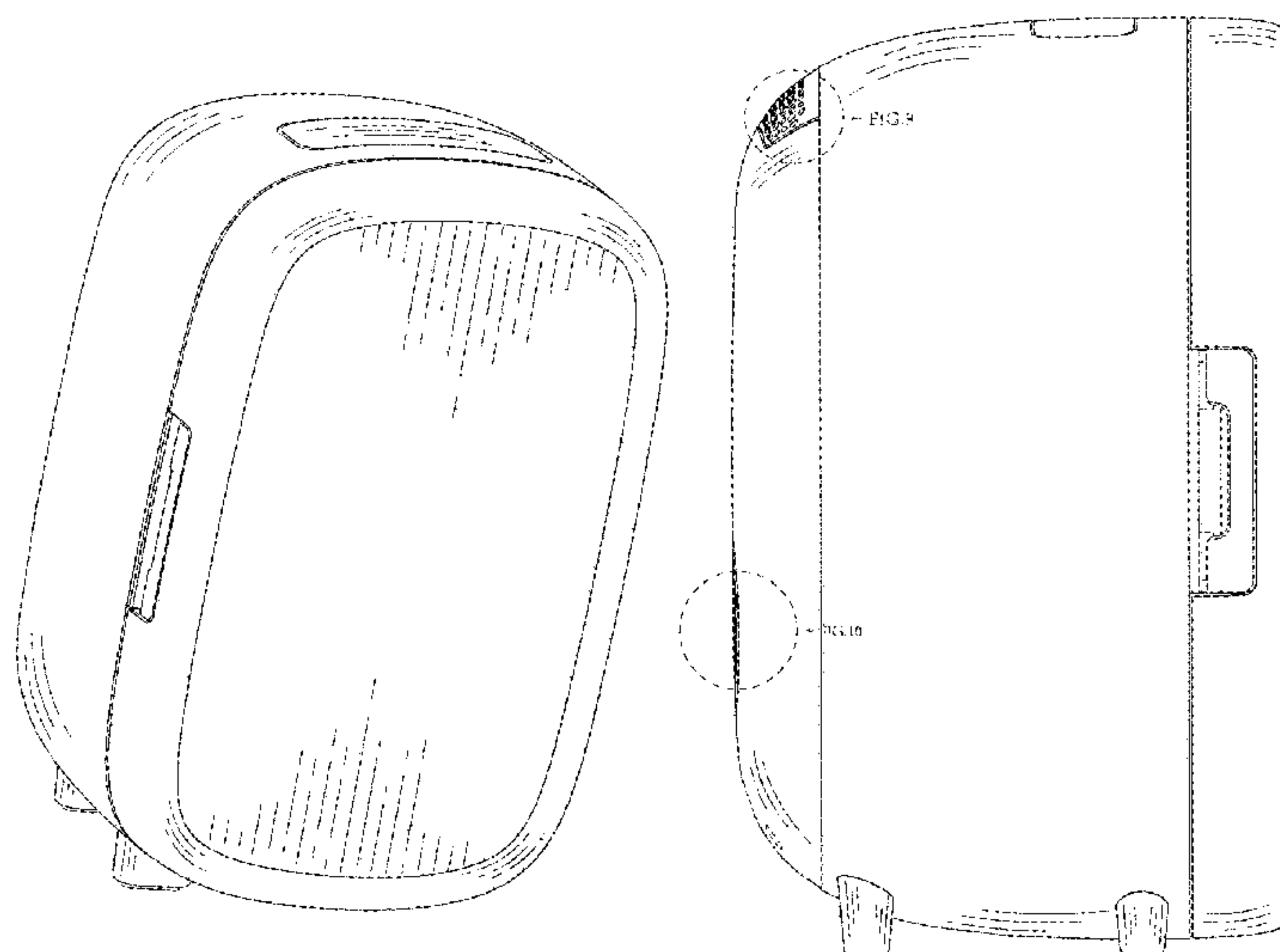

(58) **Field of Classification Search**

CPC ..... F25D 2317/061; F25D 2323/023; F25D 23/028; F25D 23/126; F25D 11/02; F25D 2201/126; F25D 2201/1262; F25D 2201/14; F25D 2323/021; F25D 23/02; F25D 23/025; F25D 23/04; F25D 23/062; F25D 23/064; F25D 23/065; F25D 23/067; F25D 2400/361; F25D 25/025; F25D 25/04; F25D 29/005; F25D 29/006; F25D 31/005; F25D 3/06

See application file for complete search history.

(56) **References Cited**

U.S. PATENT DOCUMENTS

D502,471	S	*	3/2005	Yuen	.....	D15/81
D509,359	S	*	9/2005	Chang	.....	D3/279
D776,171	S	*	1/2017	Wang	.....	D15/88
D800,799	S	*	10/2017	Feng	.....	D15/81
D807,929	S	*	1/2018	Feng	.....	D15/81
D826,996	S	*	8/2018	Feng	.....	D15/91
D852,853	S	*	7/2019	Kim	.....	D15/81
D877,210	S	*	3/2020	Letcher	.....	D15/80
D880,540	S	*	4/2020	Xie	.....	D15/83
D886,163	S	*	6/2020	Yao	.....	D15/81
D896,856	S	*	9/2020	Zhou	.....	D15/81
D906,422	S	*	12/2020	Huang	.....	D19/85
D916,144	S	*	4/2021	Deng	.....	D15/79
D919,678	S	*	5/2021	Yang	.....	D15/81
D924,946	S	*	7/2021	Xu	.....	D15/81
D937,910	S	*	12/2021	Huang	.....	D15/81
2003/0034025	A1	*	2/2003	Williams	.....	A47J 37/0786 126/41 R
2003/0084670	A1	*	5/2003	Kim	.....	F25D 29/00 62/3.6
2003/0226363	A1	*	12/2003	Lee	.....	F25D 29/008 62/3.6
2005/0132740	A1	*	6/2005	Kwon	.....	F25D 23/04 62/441
2006/0218937	A1	*	10/2006	Park	.....	A61L 2/26 62/3.3
2006/0255164	A1	*	11/2006	Oppermann	.....	F24F 3/14 236/44 C
2013/0181592	A1	*	7/2013	Betesh	.....	F25D 23/028 312/405

FOREIGN PATENT DOCUMENTS

GB	6110709	*	12/2020
JP	D1645369	*	11/2019

JP	D1681311	*	3/2021
JP	D1681312	*	3/2021
KR	301111796.0000	*	6/2021

OTHER PUBLICATIONS

S One Beauty Fridge [Online] URL: [https://www.amazon.com/BS-ONE/dp/B08SGMK7Q6/ref=sr\\_1\\_14?dchild=1&keywords=mini+fridge&qid=1628275481&s=beauty&](https://www.amazon.com/BS-ONE/dp/B08SGMK7Q6/ref=sr_1_14?dchild=1&keywords=mini+fridge&qid=1628275481&s=beauty&) (site visited: Aug. 6, 2021) (Year: 2021).\*

Flawless Beauty Mini Fridge [Online] URL: [https://www.amazon.com/Flawless-Portable-Cosmetic-SkincareRefrigerator/dp/B08BPF43BP/ref=sr\\_1\\_28?dchild=1&keywords=mini%2Bfridge&qid=1628275481&s=beauty&sr=1-28&](https://www.amazon.com/Flawless-Portable-Cosmetic-SkincareRefrigerator/dp/B08BPF43BP/ref=sr_1_28?dchild=1&keywords=mini%2Bfridge&qid=1628275481&s=beauty&sr=1-28&) (site visited: Aug. 6, 2021) (Year: 2021).\*

IKER 12 Liter Mini Fridge [Online] URL: <https://www.amazon.com/IKERSkincare-Cosmetics-Portable-Suitable/dp/B0911RVGL2/> (full link in attached NPL; site visited: Aug. 6, 2021) (Year: 2021).\*

Professional Beauty Refrigerator [Online] URL: <https://www.amazon.com/Professional-Refrigerator-Mini-> (site visited: Aug. 6, 2021) (Year: 2021).\*

Avery Rose Mini Skin Care Fridge for Makeup and Cosmetic [Online] URL: <https://averyrosebeauty.com/products/beauty-fridge-for-make-up> (site visited: Aug. 6, 2021) (Year: 2021).\*

Caynel 12 Liter Meeta Beauty Mini Fridge [Online] URL: <https://www.walmart.com/ip/Caynel-12-Liter-Meeta-Beauty-Mini-Fridge-with-Smart-Breathing-Light-Display/409415330?> (site visited: Aug. 6, 2021) (Year: 2021).\*

China 13L Custom Portable Beauty Makeup [Online] URL: <https://www.made-in-china.com/showroom/yinyuan-kevin/product-detailHXNJmDnEqMpV/China-13L-Custom-Portable-Beauty-Makeup-Double-Door-Small-Refrigerator-Mini-Fridge-for-Cosmetic.html> (site visited: Aug. 6, 2021) (Year: 2021).\*

Cooluli Beauty 12-liter Skincare Fridge [Online] URL: <https://www.bestbuy.com/site/cooluli-beauty-12-liter-skincare-fridge-pearl-white/6457432.p?skuId=6457432>(site visited: Aug. 6, 2021) (Year: 2021).\*

QUBI Mini Fridge [Online] URL: <https://bahrain.whizzcart.com/product/10560654/qubi-mini-fridge-professional-skincare-fridge-mini-cosmetics-makeup-fridge-compact-fridge-5-liter-cream-white-5l/>(site visited: Aug. 6, 2021) (Year: 2021).\*

Teami Blends—Teami Luxe Skincare Fridge [Online] URL: <https://www.teamiblends.com/products/luxe-skincare-fridge?nbt=nb%3Aadwords%3Ag%3A13162700075%25> (site visited: Aug. 6, 2021) (Year: 2021).\*

Mini Skin Care Fridge [Online] URL: <https://www.amazon.com/Fridge-Cosmetic-Portable-Compact-Bedroom/product-reviews/B088LZMSX1/> (site visited: Aug. 6, 2021) (Year: 2020).\*

New Product Skin Care Beauty [Online] URL: <https://www.made-in-china.com/showroom/yinyuan-kevin/product-detailpKvxdHwYnorR/China-2020-New-Product-Skin-Care-Beauty-Mini-Cosmetic-Fridge-Refrigerator.html> (site visited: Aug. 6, 2021) (Year: 2020).\*

\* cited by examiner



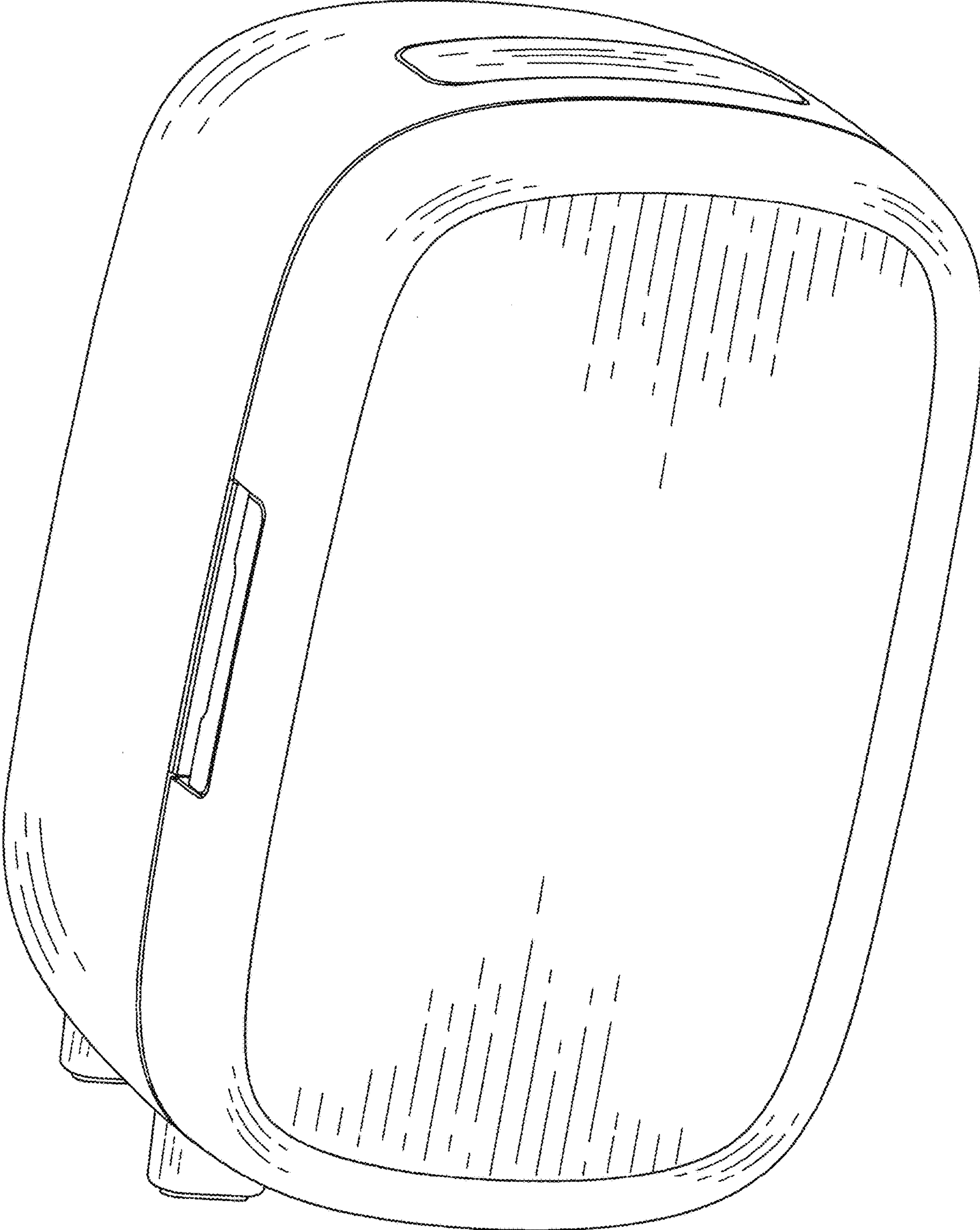

FIG. 1

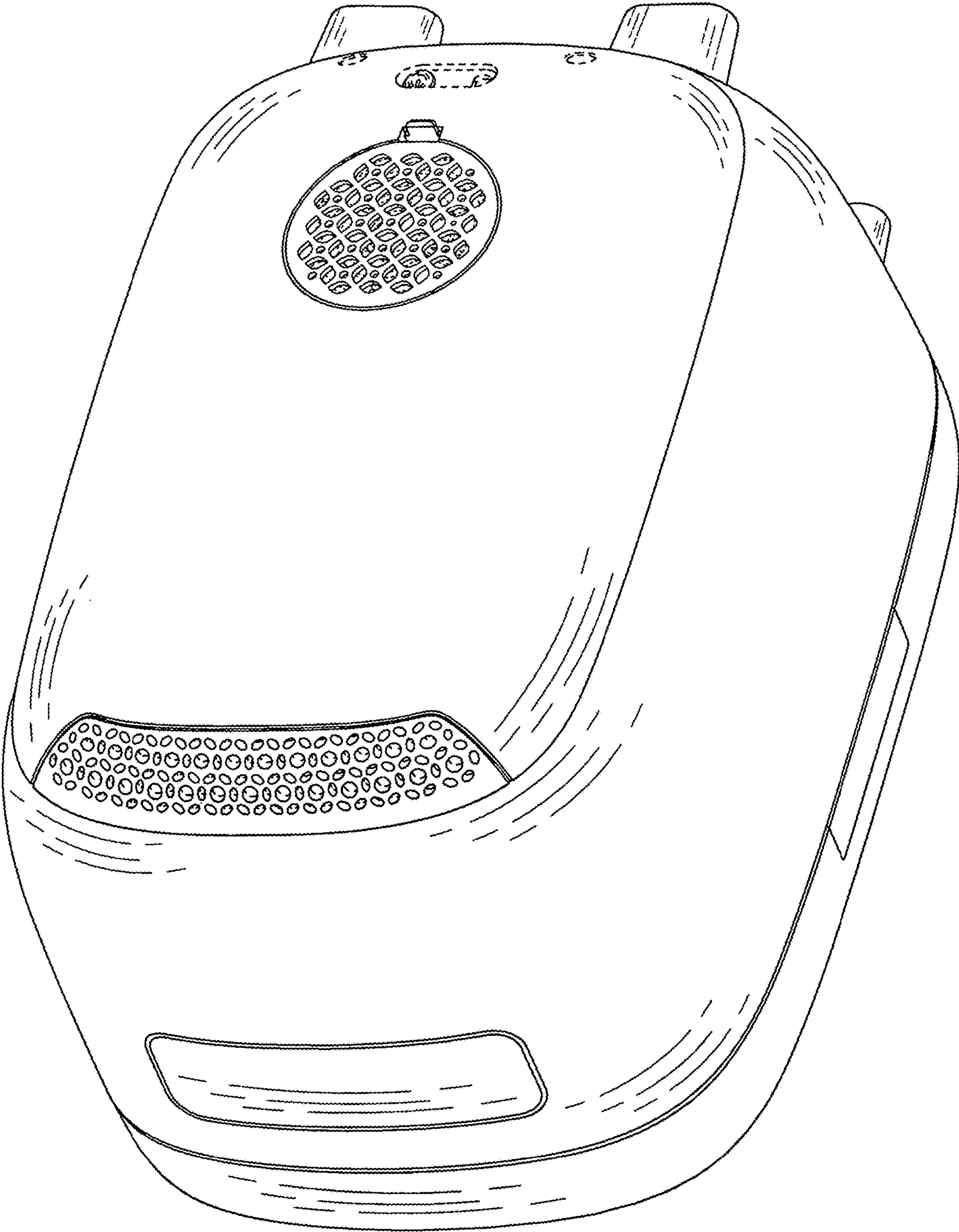

FIG. 2

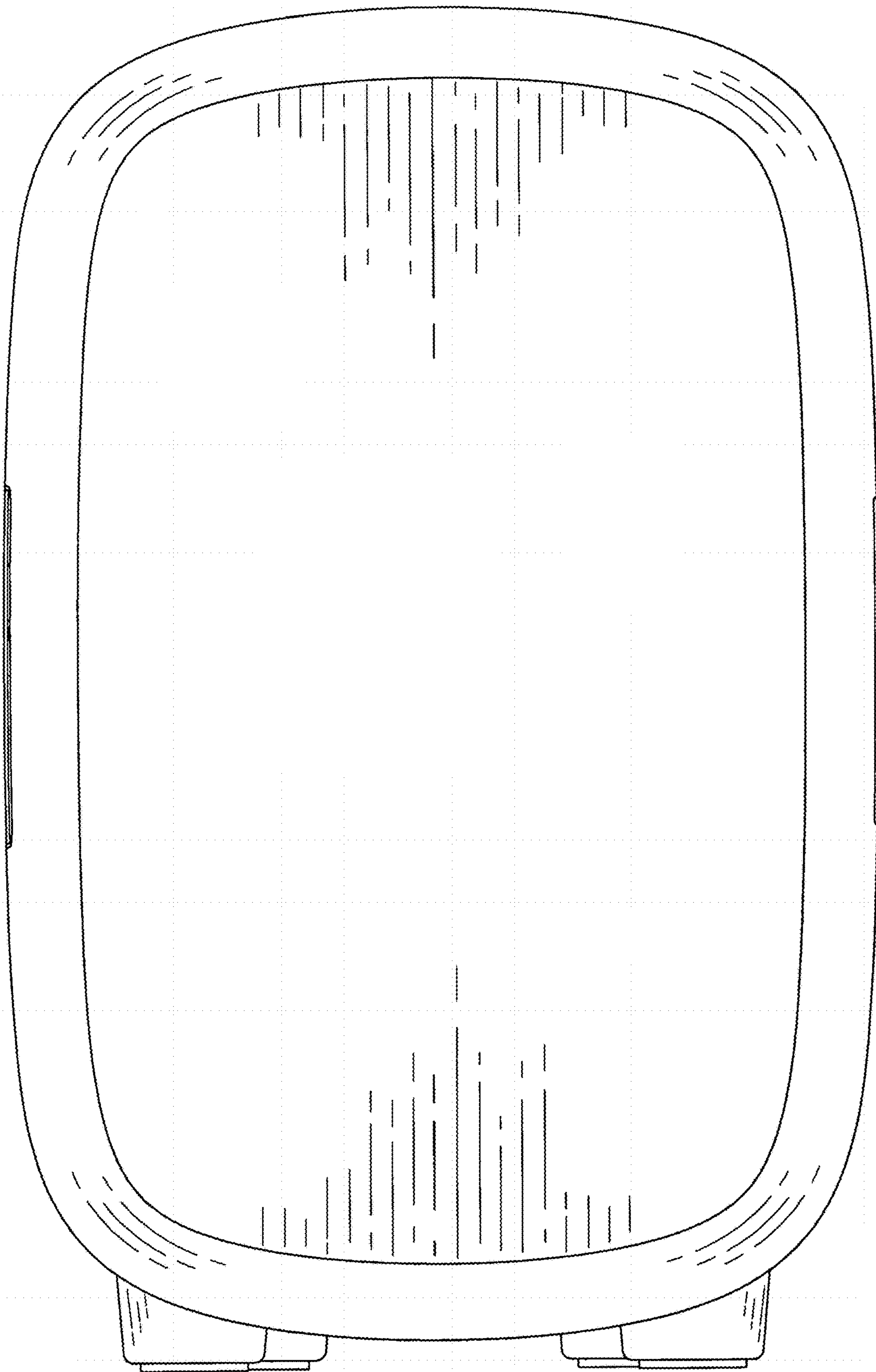

FIG. 3



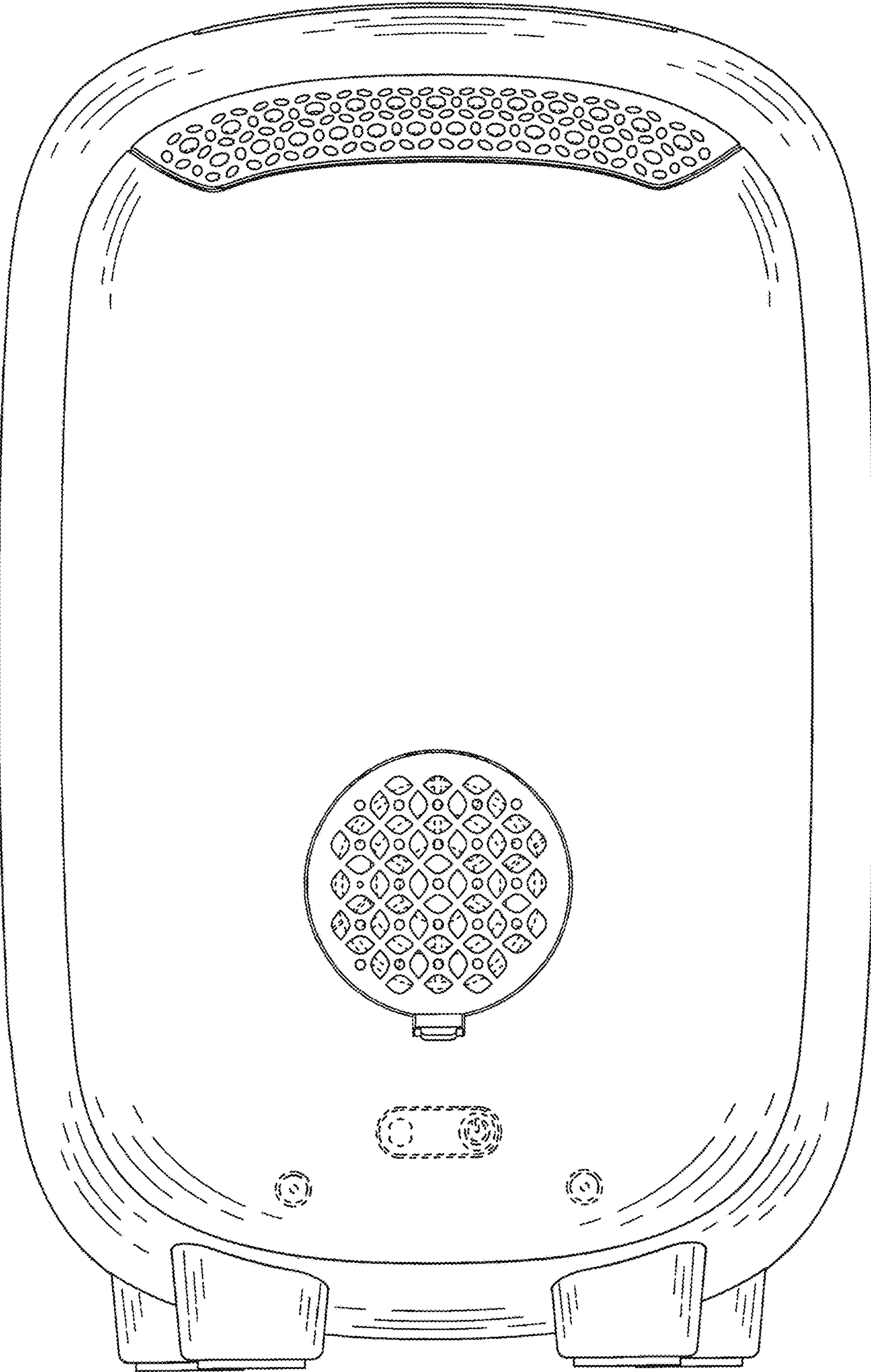
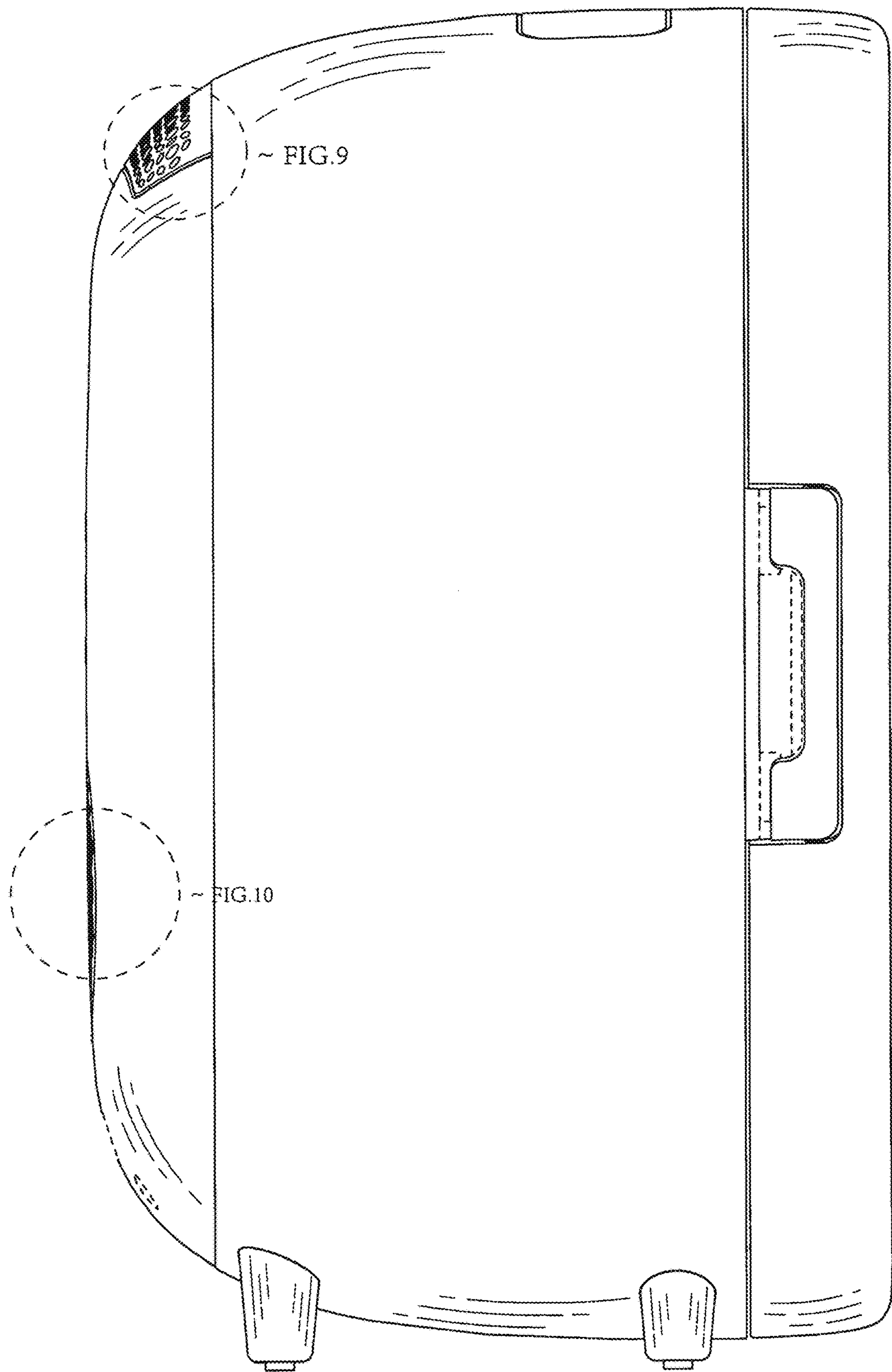

FIG. 4



~ FIG.9

~ FIG.10

FIG. 5

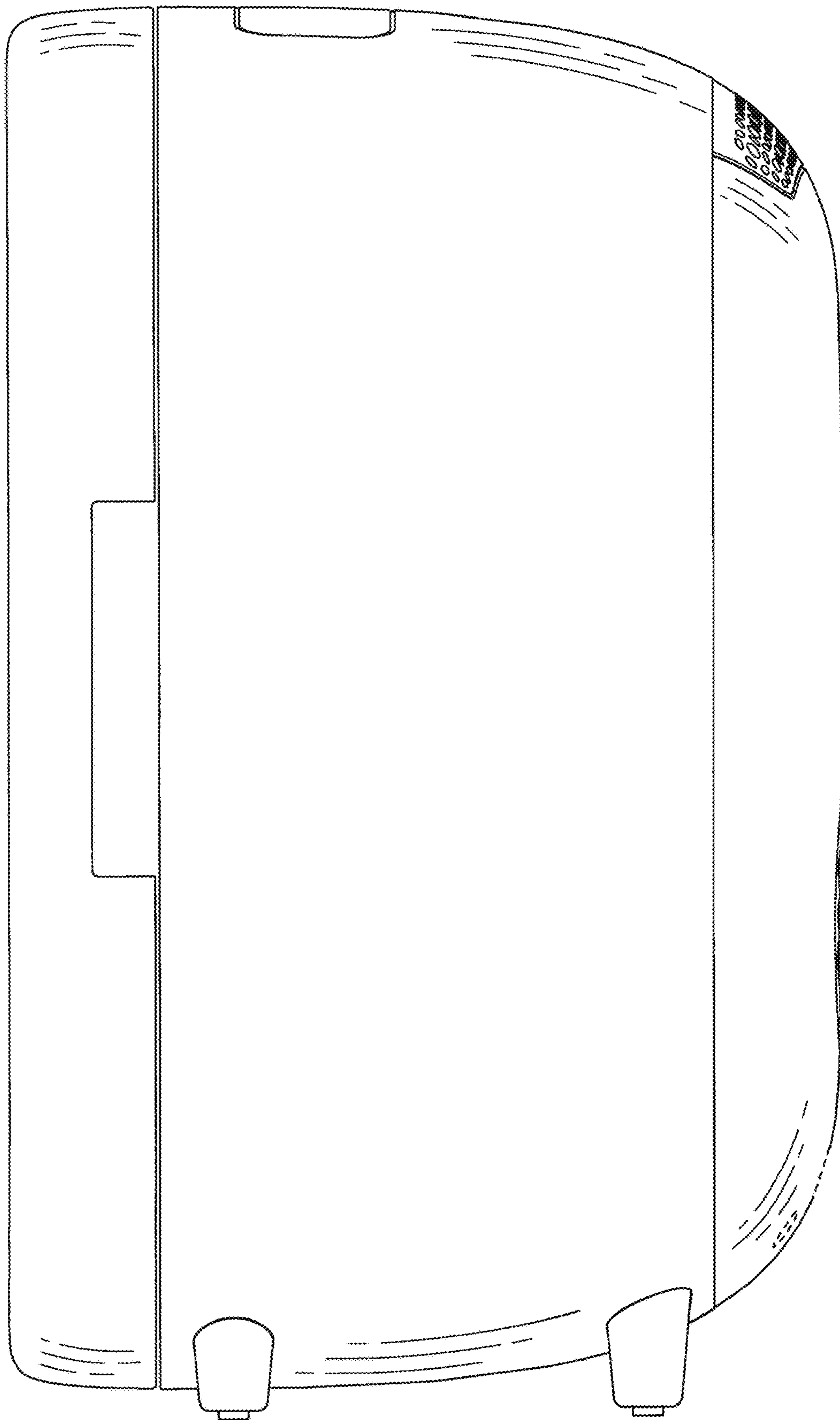

FIG. 6



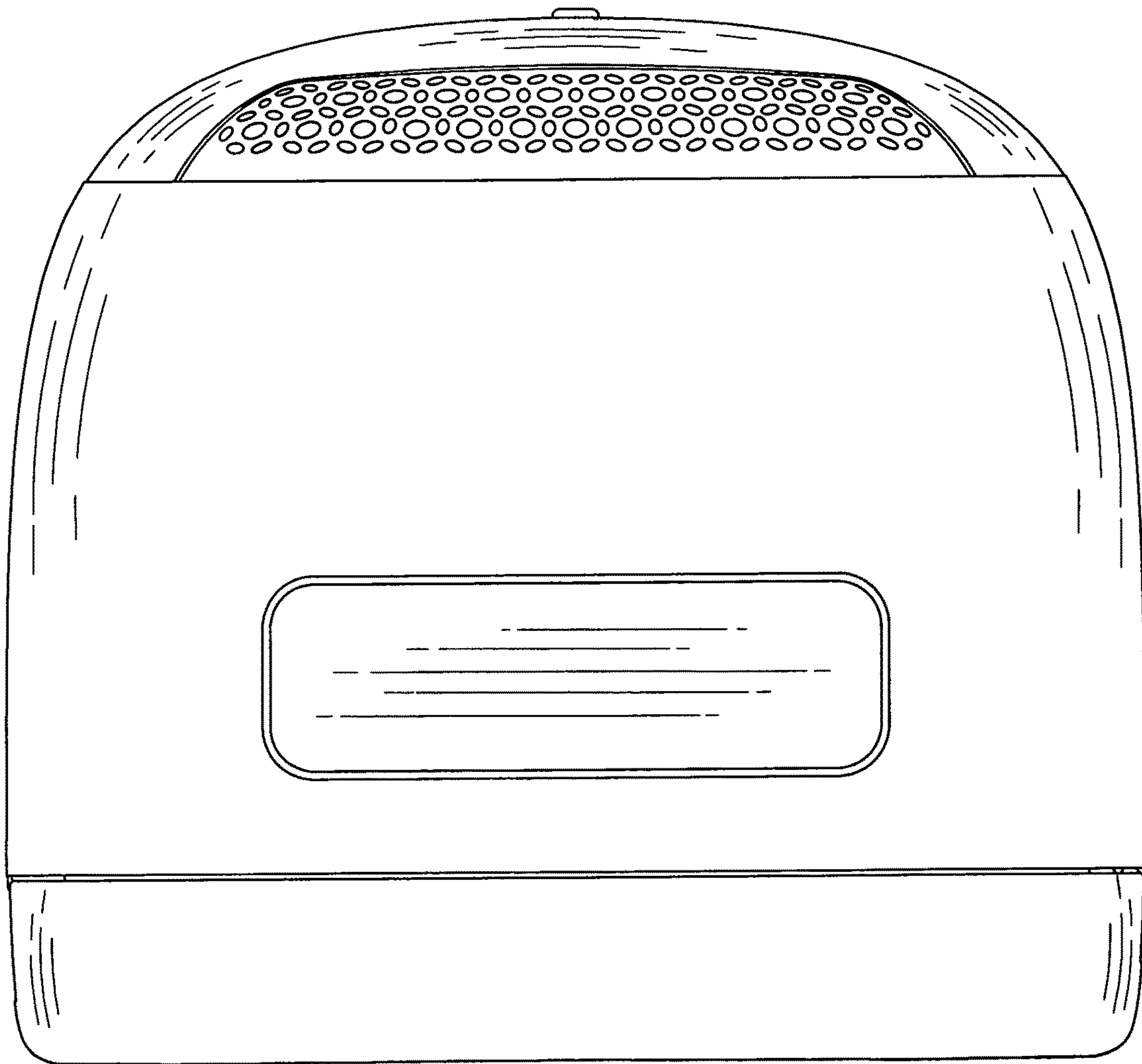

FIG. 7

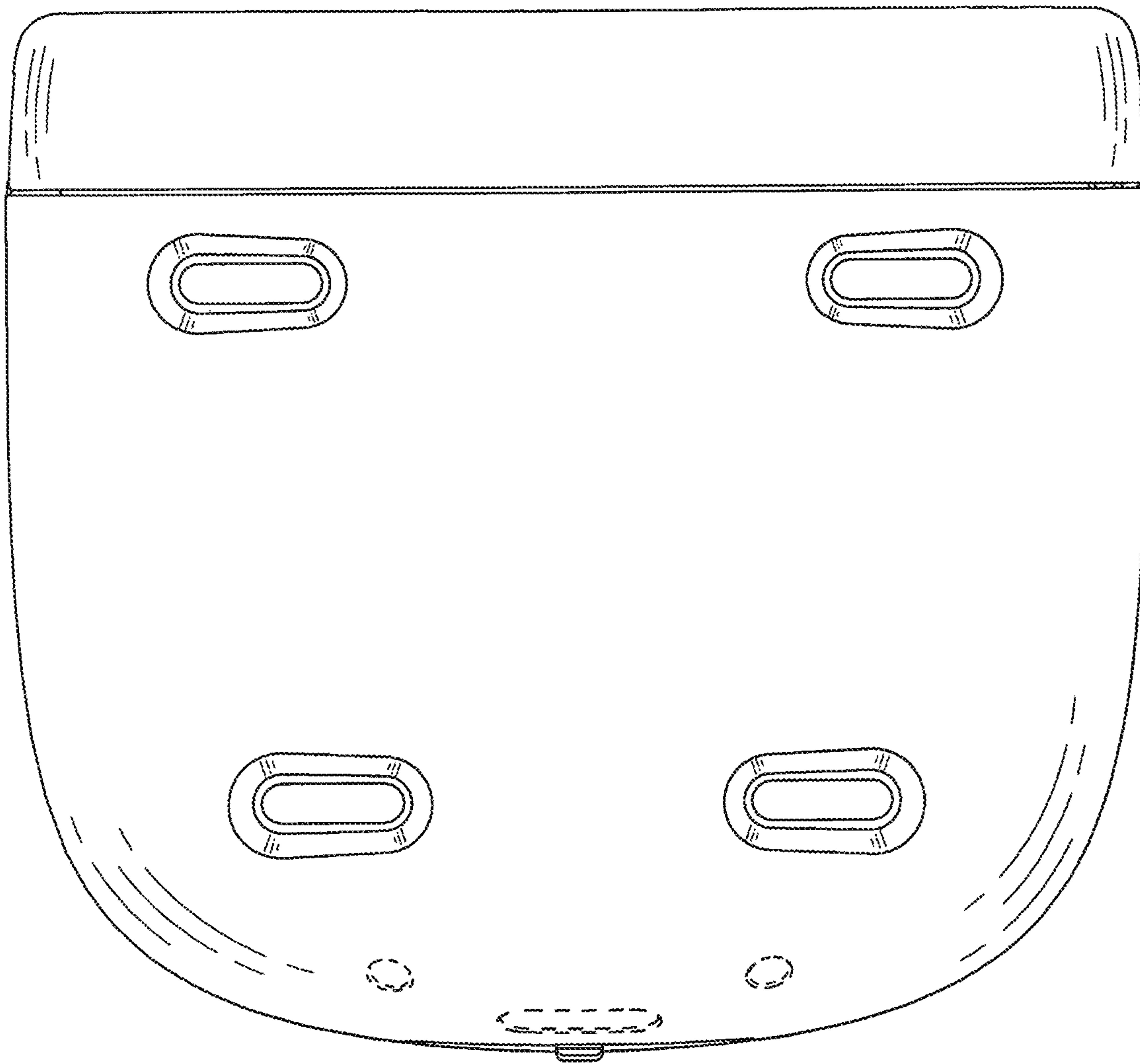

FIG. 8

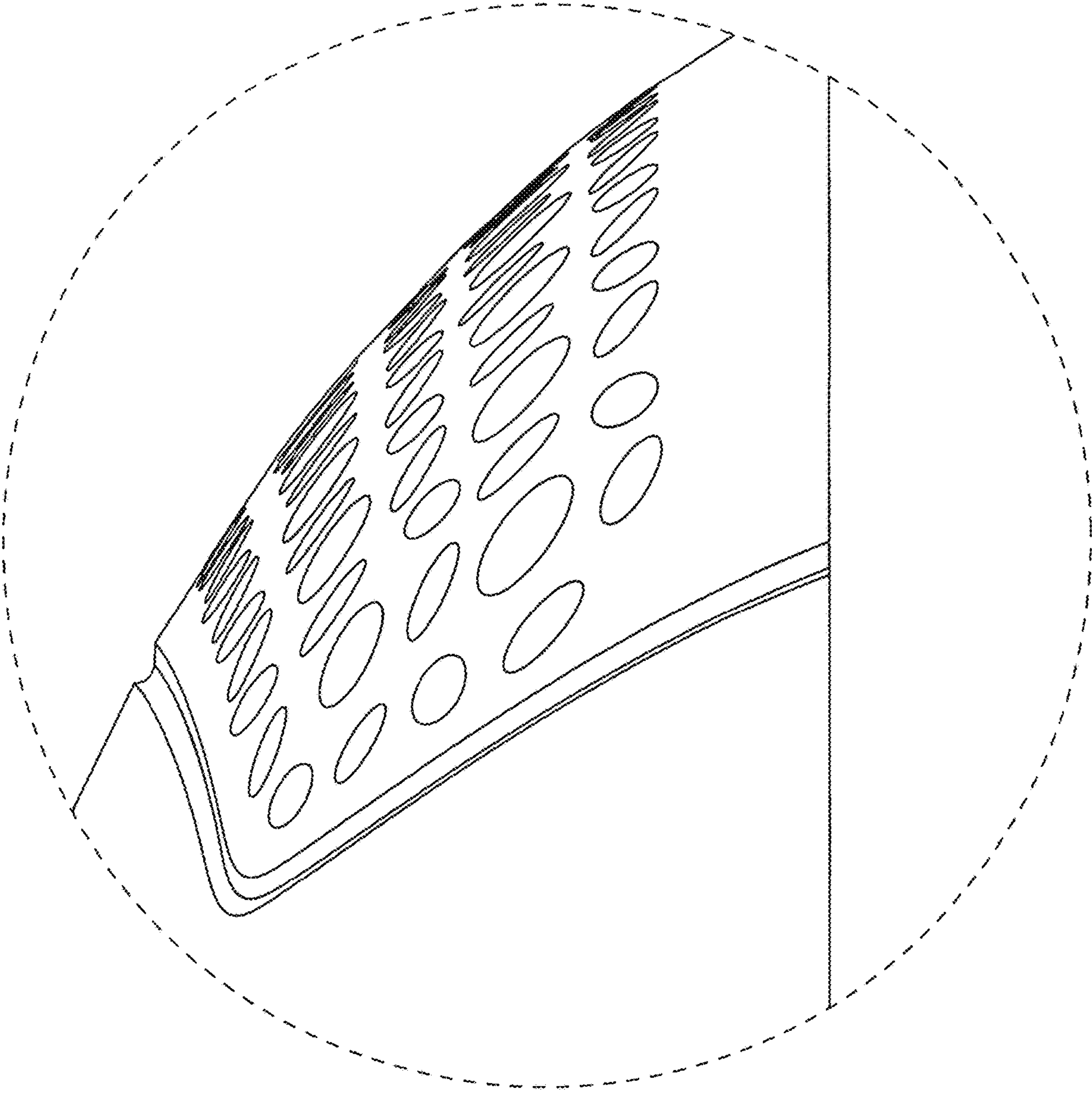

FIG. 9



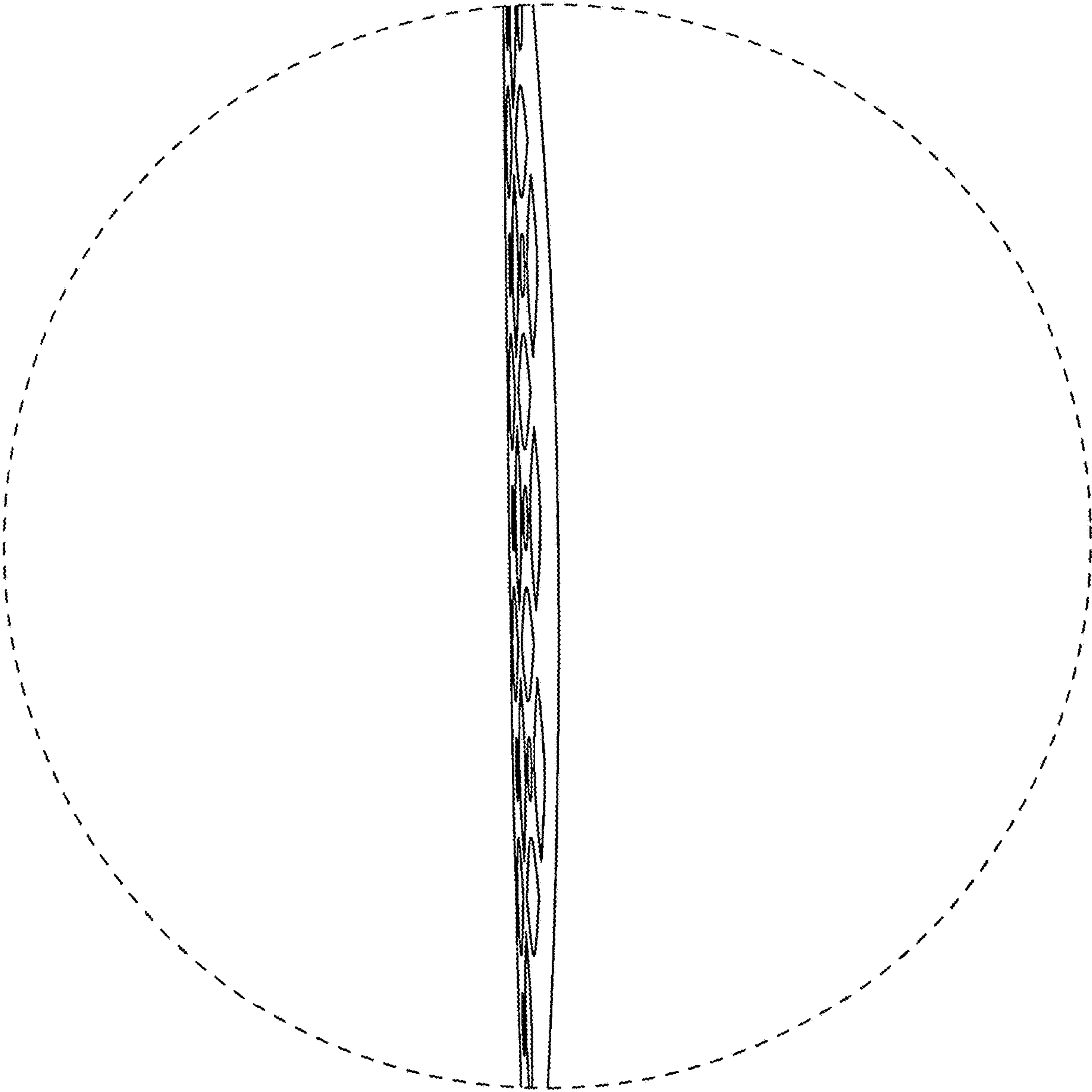

FIG. 10