



US00D952603S

(12) **United States Design Patent**
Wen

(10) **Patent No.:** **US D952,603 S**

(45) **Date of Patent:** **** May 24, 2022**

(54) **LOUDSPEAKER**

(71) Applicant: **Guangzhou Muka Intelligent Technology Co., Ltd., Guangzhou (CN)**

(72) Inventor: **Zhiwei Wen, Shenzhen (CN)**

(**) Term: **15 Years**

(21) Appl. No.: **29/752,756**

(22) Filed: **Sep. 29, 2020**

(51) **LOC (13) Cl.** **14-01**

(52) **U.S. Cl.**
USPC **D14/214; D14/192; D14/225**

(58) **Field of Classification Search**
USPC D14/214, 192, 225, 188, 215, 496, 240, D14/137, 172, 194, 191, 159, 155, 195, D14/198, 203.5; D13/168, 184; D10/53, D10/70, 104.1; 379/433, 434, 419, 420, 379/428, 440; 224/669, 674; 455/90.3, 455/575.1, 569.1
CPC H04R 25/00; H04R 11/02; H04R 19/04; H04R 5/00; H04R 1/02; H04R 9/06; H05K 7/00; H05K 5/00; G11B 33/02; A45F 5/02

See application file for complete search history.

4,083,481 A * 4/1978 Selinko A45F 5/02
224/269

D259,564 S * 6/1981 Huntington D14/137

D262,965 S * 2/1982 Iwata D14/192

D264,080 S * 4/1982 Iwata D14/191

D268,182 S * 3/1983 Asano D14/137

D284,580 S * 7/1986 Scholz D17/20

4,635,836 A * 1/1987 Mooney A45F 5/02
224/247

D293,088 S * 12/1987 Brown D10/106.1

4,828,153 A * 5/1989 Guzik A45F 5/02
224/242

5,488,759 A * 2/1996 Lim A45F 5/02
24/3.12

D369,168 S * 4/1996 Yano D14/194

(Continued)

FOREIGN PATENT DOCUMENTS

CN 303805333 * 8/2016

CN 304005356 * 1/2017

(Continued)

Primary Examiner — Paula Allen Greene

(57) **CLAIM**

The ornamental design for a loudspeaker, shown and described.

DESCRIPTION

FIG. 1 is a perspective view of a loudspeaker showing my new design;

FIG. 2 is a front view thereof;

FIG. 3 is a back view thereof;

FIG. 4 is a left side view thereof;

FIG. 5 is a right side view thereof;

FIG. 6 is a top view thereof; and,

FIG. 7 is a bottom view thereof.

The broken lines shown in the drawings depict portions of the loudspeaker in which the design is embodied that form no part of the claimed design.

1 Claim, 7 Drawing Sheets

(56) **References Cited**

U.S. PATENT DOCUMENTS

2,924,705 A * 2/1960 Jones H04B 5/0006
455/269

3,070,748 A * 12/1962 Worobey H04B 1/086
455/343.1

3,132,712 A * 5/1964 Maddy H04R 1/288
181/151

3,623,189 A * 11/1971 Wilczynski A45F 5/02
24/3.11

3,956,701 A * 5/1976 James, Jr. G08B 3/1058
343/702

D240,835 S * 8/1976 Toth et al. D14/137

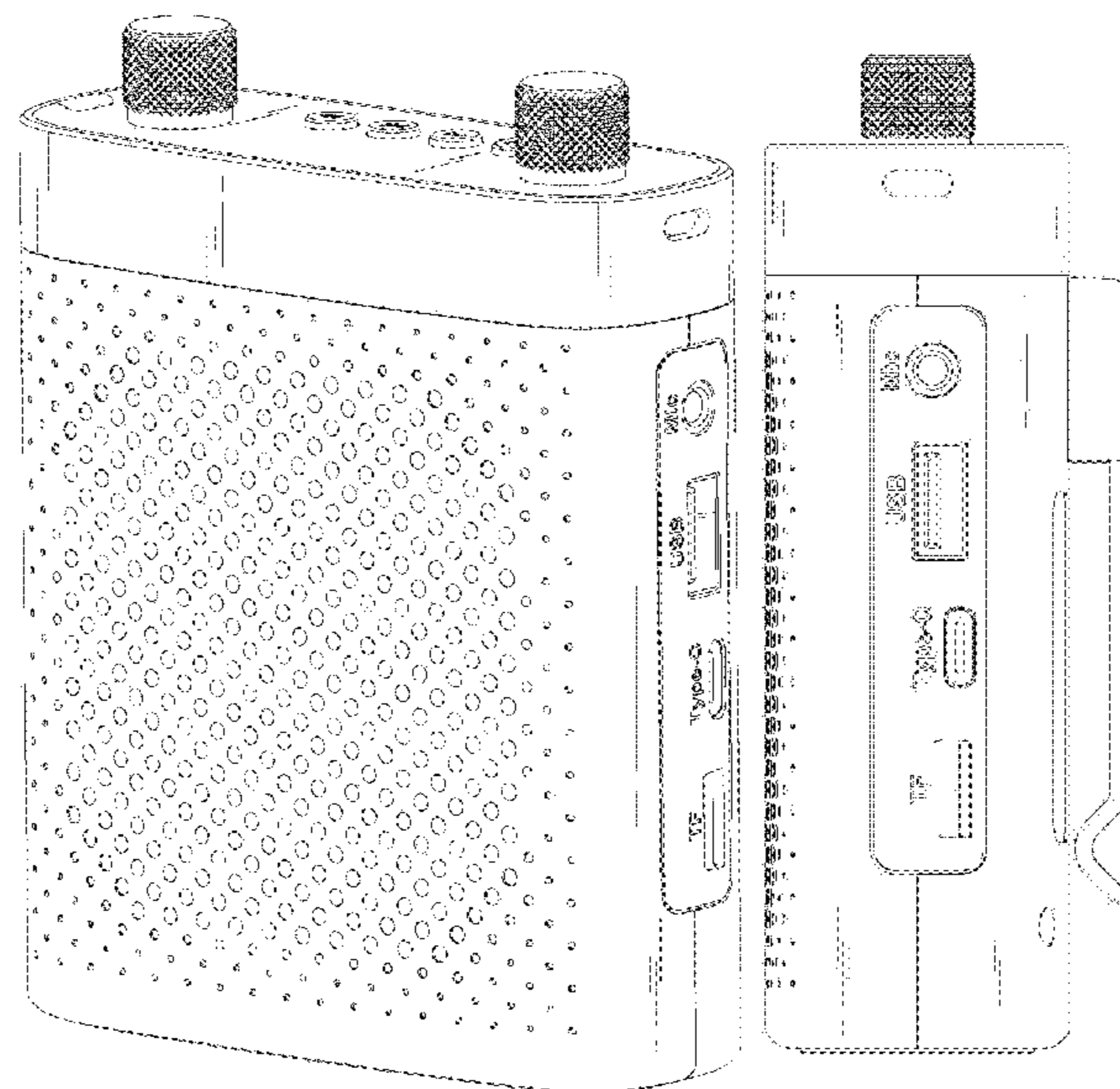

(56)

References Cited

U.S. PATENT DOCUMENTS

D376,146 S * 12/1996 Totsch D14/155
 5,609,886 A * 3/1997 Wantier A61K 9/1647
 424/1.25
 D412,705 S * 8/1999 Laiacona D14/172
 D438,857 S * 3/2001 Ishii D14/161
 D441,744 S * 5/2001 Miyazaki D14/137
 D454,110 S * 3/2002 Andre D13/110
 6,891,721 B2 * 5/2005 Huang G11B 25/043
 361/679.33
 D520,502 S * 5/2006 Xu D14/356
 D568,877 S * 5/2008 Bodley D14/225
 D575,729 S * 8/2008 Nomi D13/107
 D576,164 S * 9/2008 Takahashi D14/385
 D577,700 S * 9/2008 Akita D14/137
 D578,105 S * 10/2008 Komiyama D14/214
 D587,244 S * 2/2009 Lim D14/214
 D594,002 S * 6/2009 Kettula D14/240
 D606,035 S * 12/2009 Tan D14/137
 D626,552 S * 11/2010 Andre D14/341
 D627,330 S * 11/2010 Otsuka D14/192
 D649,524 S * 11/2011 Miyazaki D14/167
 D655,276 S * 3/2012 Joseph D14/214
 D659,037 S * 5/2012 Madsen D10/65
 D667,007 S * 9/2012 Huang D14/358
 D692,848 S * 11/2013 Poandl D14/172
 D697,052 S * 1/2014 Loudon D14/214
 D715,258 S * 10/2014 Osborn D14/214
 D718,277 S * 11/2014 Yamamoto D14/214
 D719,932 S * 12/2014 Osborn D14/214
 D734,739 S * 7/2015 Green D14/214
 D754,103 S * 4/2016 Fischer D14/214
 D755,160 S * 5/2016 Ponce D14/214

D760,684 S * 7/2016 Green D14/204
 D778,889 S * 2/2017 Nagao D14/240
 D785,597 S * 5/2017 Fung D14/216
 D798,838 S * 10/2017 DiTullo D14/214
 D800,085 S * 10/2017 Shepher D14/138 R
 D806,679 S * 1/2018 Demin D14/214
 D817,925 S * 5/2018 Jang D14/214
 D844,587 S * 4/2019 Lu D14/214
 D889,430 S * 7/2020 Teruzzi D14/204
 D894,161 S * 8/2020 Ye D14/225
 D917,431 S * 4/2021 Gao D14/225
 D923,603 S * 6/2021 Ming D14/214
 D924,834 S * 7/2021 DeLuna D14/204
 D925,504 S * 7/2021 Wang D14/225
 D929,361 S * 8/2021 Bringman D14/204
 D931,826 S * 9/2021 Huang D14/192
 D931,827 S * 9/2021 Huang D14/192
 D933,038 S * 10/2021 Huang D14/192
 D934,206 S * 10/2021 Liu D14/225
 2013/0001971 A1 * 1/2013 Stein H04R 1/023
 296/1.08
 2013/0230752 A1 * 9/2013 Fujihara H01M 50/342
 429/82
 2015/0381333 A1 * 12/2015 Tennant H04M 1/03
 370/278
 2018/0098140 A1 * 4/2018 Nam H04R 1/26

FOREIGN PATENT DOCUMENTS

CN 305631015 * 2/2020
 CN 306441754 * 4/2021
 CN 306984719 * 12/2021
 CN 307002554 * 12/2021
 CN 307018904 * 12/2021

* cited by examiner

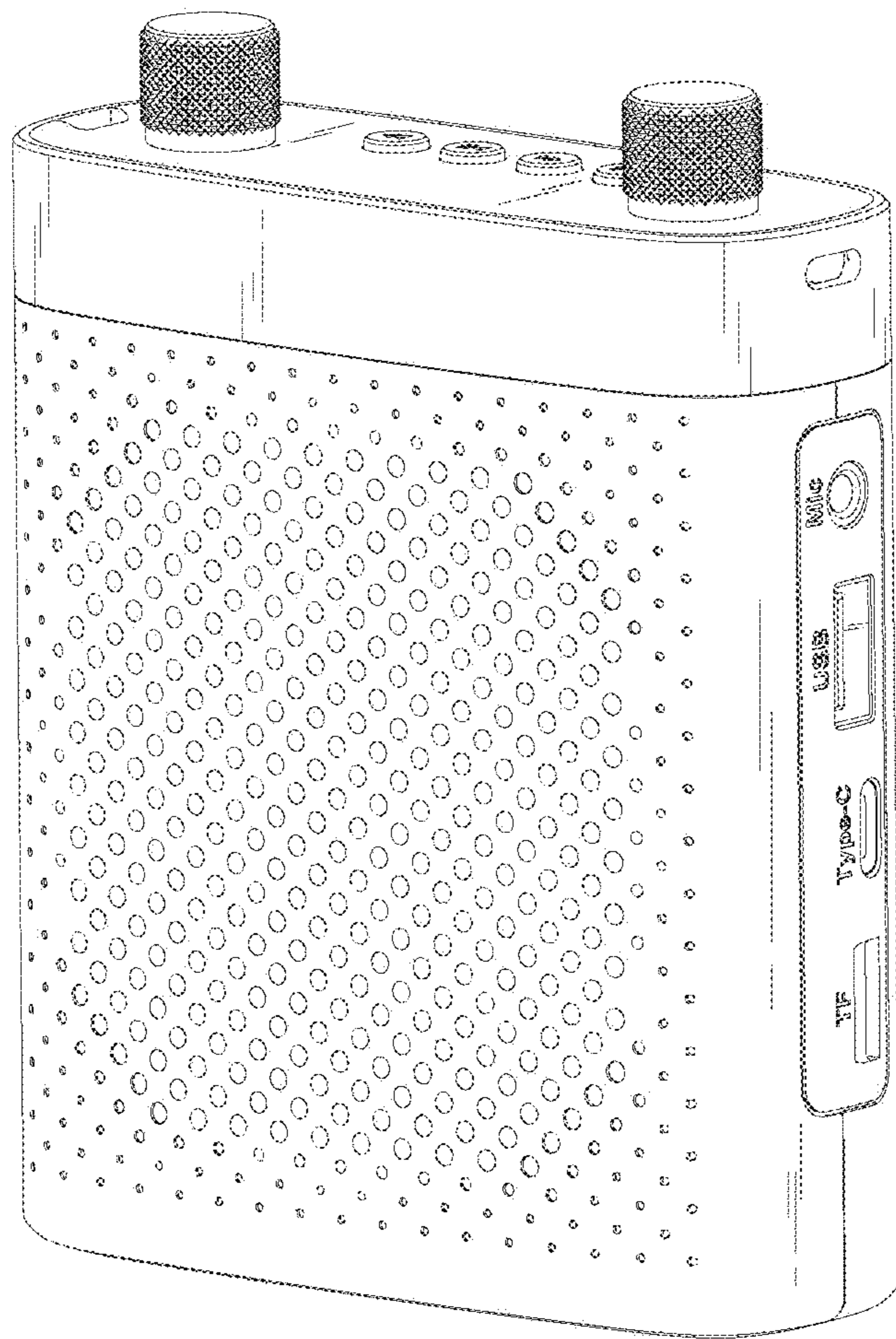

FIG.1

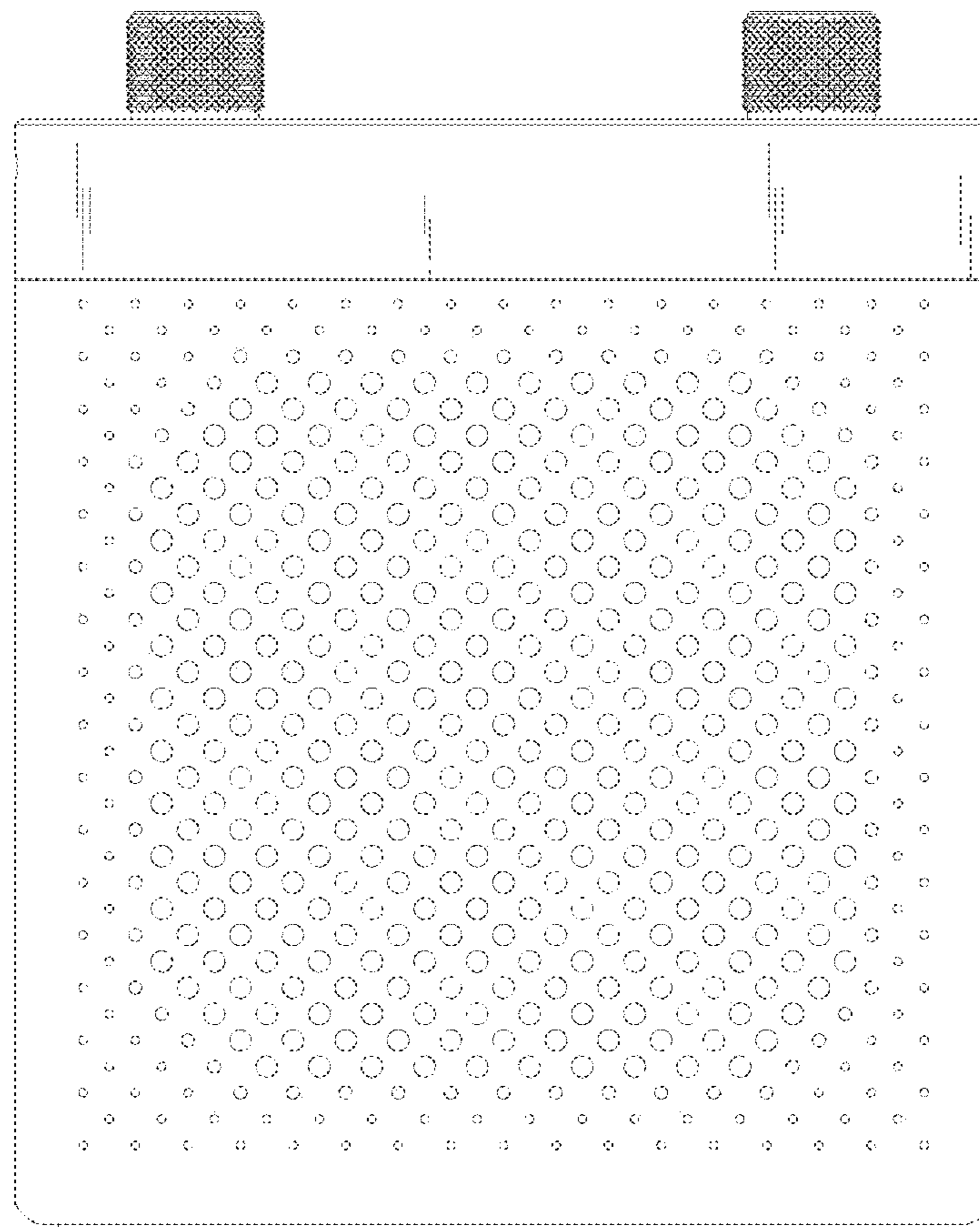

FIG. 2

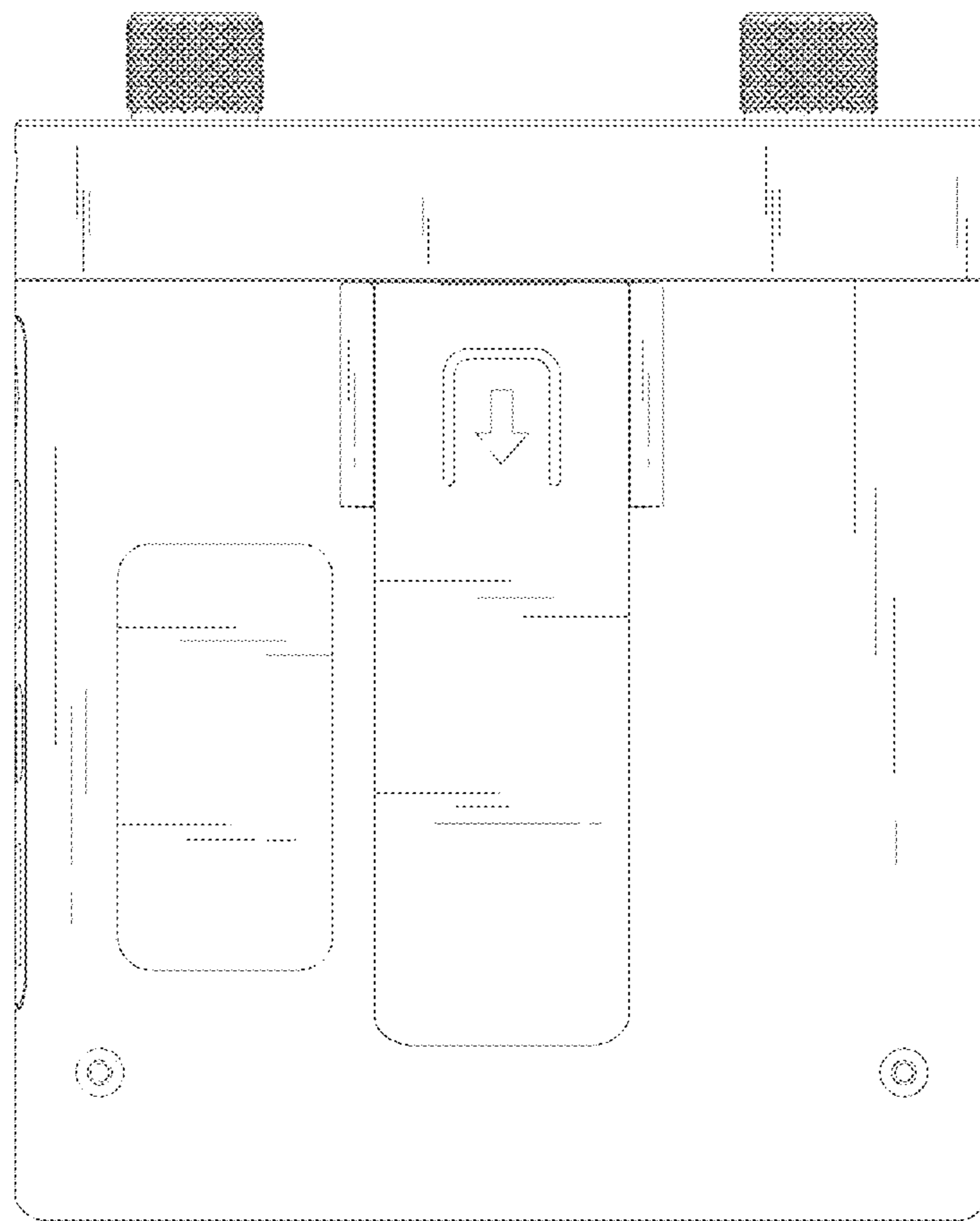

FIG. 3

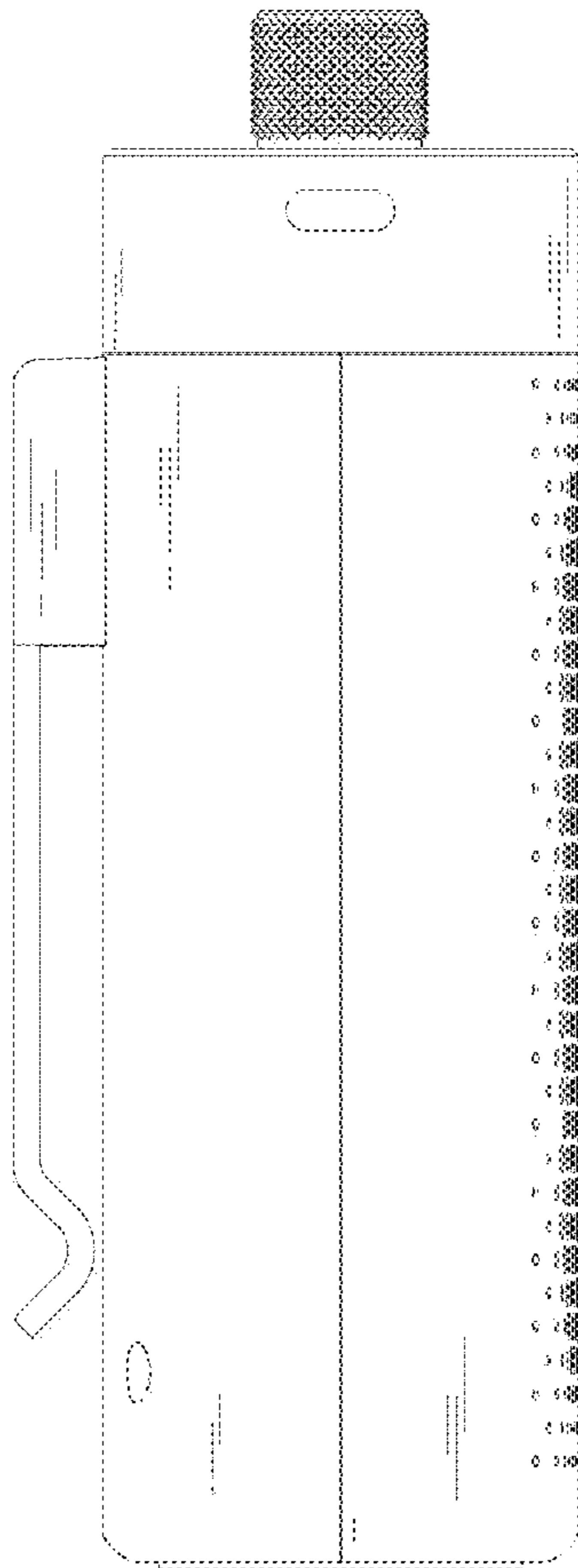

FIG.4

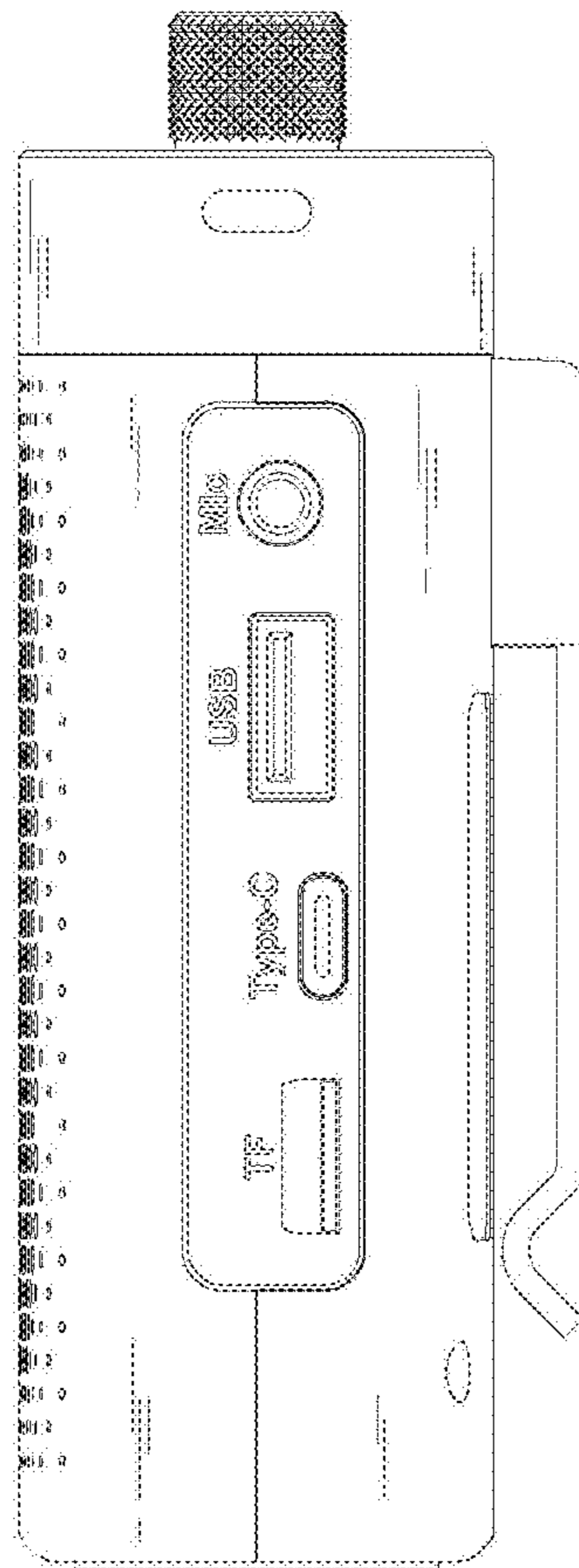

FIG. 5

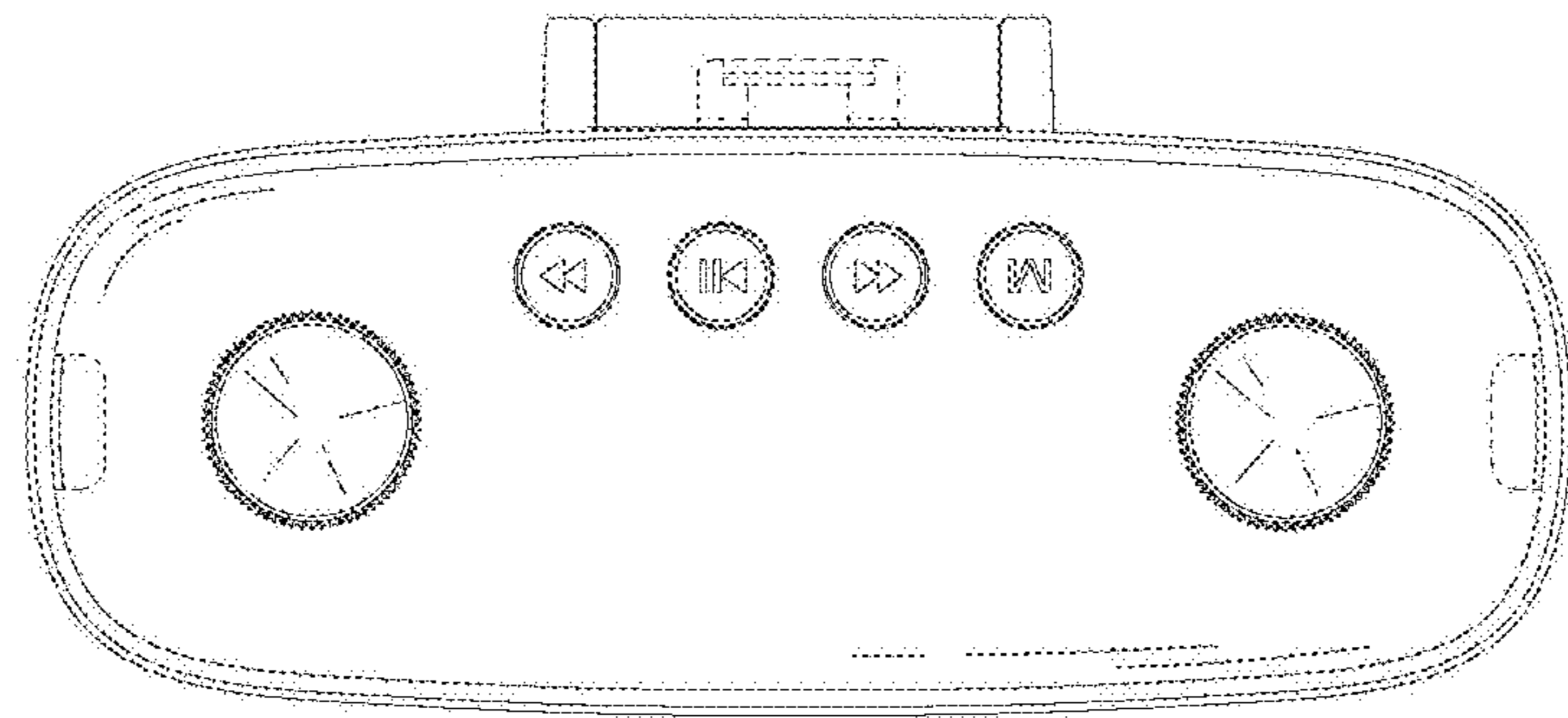

FIG. 6

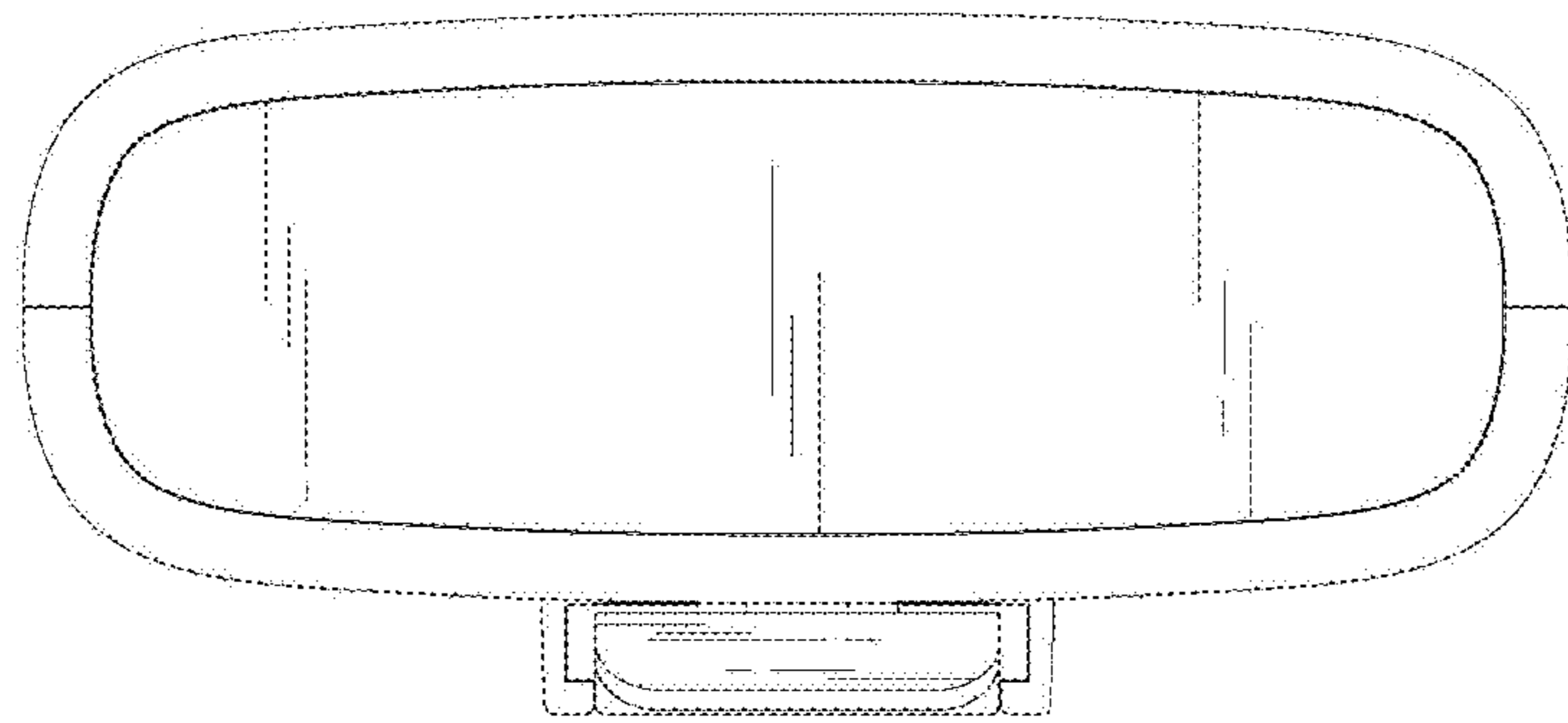

FIG. 7