



US00D952516S

(12) **United States Design Patent**
Borkert

(10) **Patent No.:** **US D952,516 S**
(45) **Date of Patent:** **** May 24, 2022**

(54) **CAR, TOY CAR REPLICA AND/OR OTHER REPLICA**

D813,725 S * 3/2018 Filippini et al. D12/91
D833,911 S * 11/2018 Borkert D12/91
D844,489 S * 4/2019 Alexiev D12/91
D915,239 S * 4/2021 Cattabriga et al. D12/91

(71) Applicant: **AUTOMOBILI LAMBORGHINI S.P.A.**, Sant'Agata Bolognese (IT)

FOREIGN PATENT DOCUMENTS

(72) Inventor: **Mitja Borkert**, Castelnuovo Rangone (IT)

JP 1611579 7/2018
KR 30-0366828 11/2004

(73) Assignee: **AUTOMOBILI LAMBORGHINI S.P.A.**, Sant'agata Bolognese (IT)

OTHER PUBLICATIONS

(**) Term: **15 Years**

Japanese Search Report dated Nov. 9, 2020 from related Japanese Patent Application No. 2020-009335.

(21) Appl. No.: **29/735,183**

* cited by examiner

(22) Filed: **May 19, 2020**

Primary Examiner — Melody N Brown

(30) **Foreign Application Priority Data**

(74) *Attorney, Agent, or Firm* — Shuttleworth & Ingersoll, PLC; Timothy J. Klima

Nov. 20, 2019 (EM) 007266192-0001

(51) **LOC (13) Cl.** **12-08**

(52) **U.S. Cl.**
USPC **D12/88**

(58) **Field of Classification Search**
USPC D12/86, 90-92, 164, 83, 87; D21/433,
D21/434, 531-535, 550;
296/181.1-181.5, 183.1
CPC B62D 25/00; B62D 25/06; B62D 33/00;
B62D 35/00

See application file for complete search history.

(57) **CLAIM**

The ornamental design for a car, toy car replica and/or other replica, as shown and described.

(56) **References Cited**

U.S. PATENT DOCUMENTS

D729,285 S * 5/2015 Seo et al. D12/91
D800,018 S * 10/2017 Jheow D12/91

DESCRIPTION

FIG. 1 is a top, front and right side perspective view of a car, toy car replica and/or other replica showing my new design; FIG. 2 is a right, rear perspective view thereof; FIG. 3 is a top plan view thereof; FIG. 4 is a left side elevational view thereof; FIG. 5 is a front elevational view thereof; FIG. 6 is a right side elevational view thereof; FIG. 7 is a rear elevational view thereof; and, FIG. 8 is a bottom plan view thereof.

1 Claim, 8 Drawing Sheets

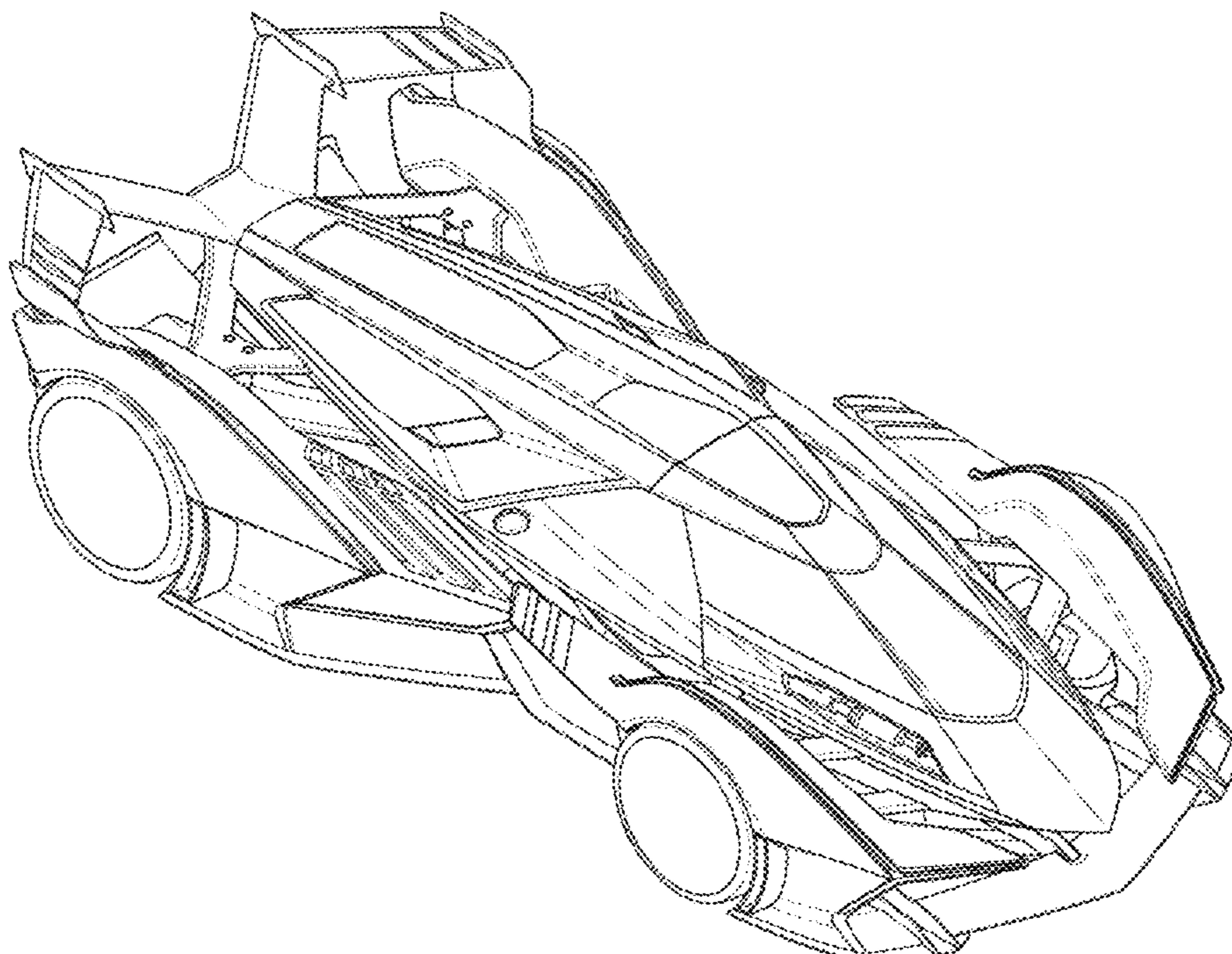
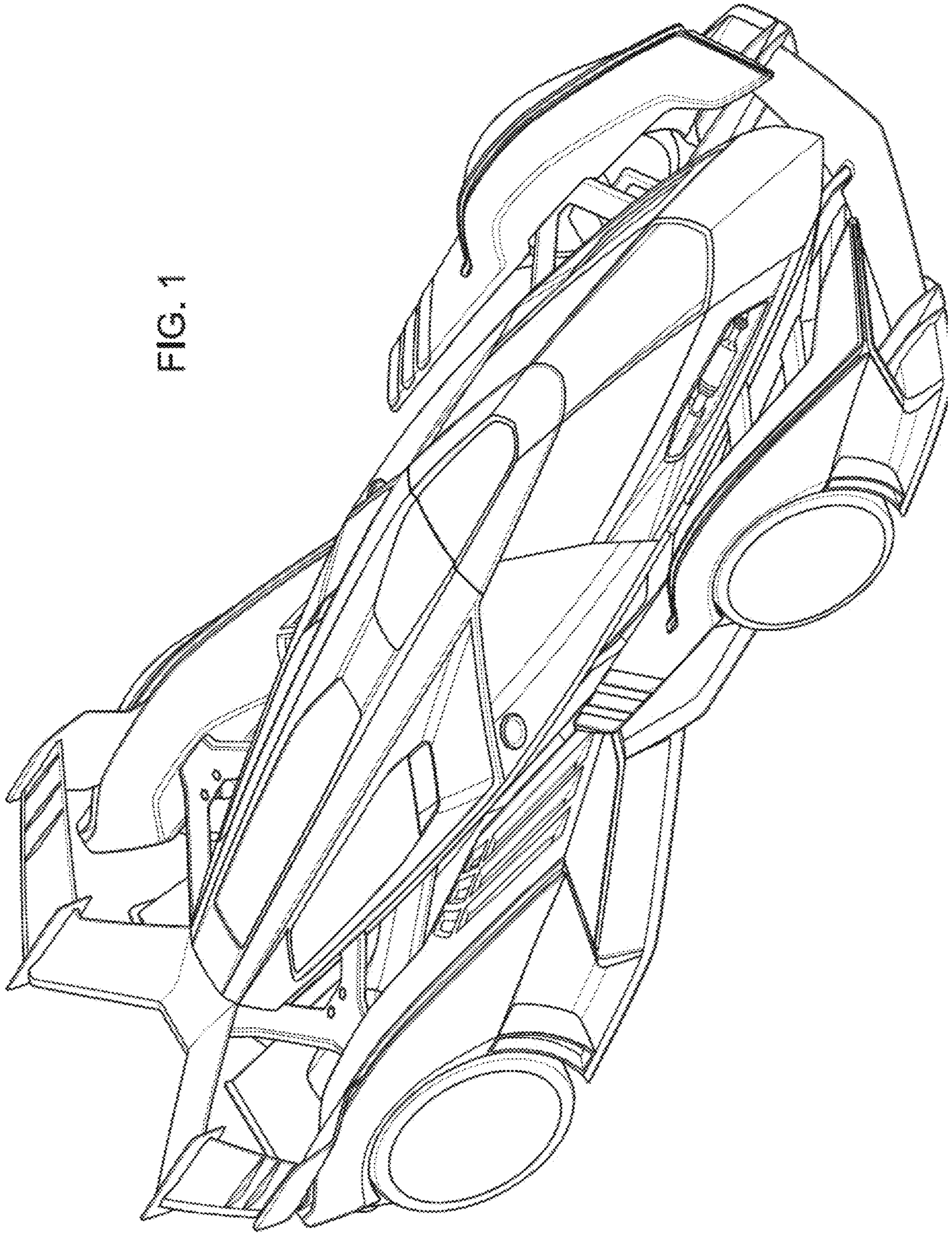

FIG. 1



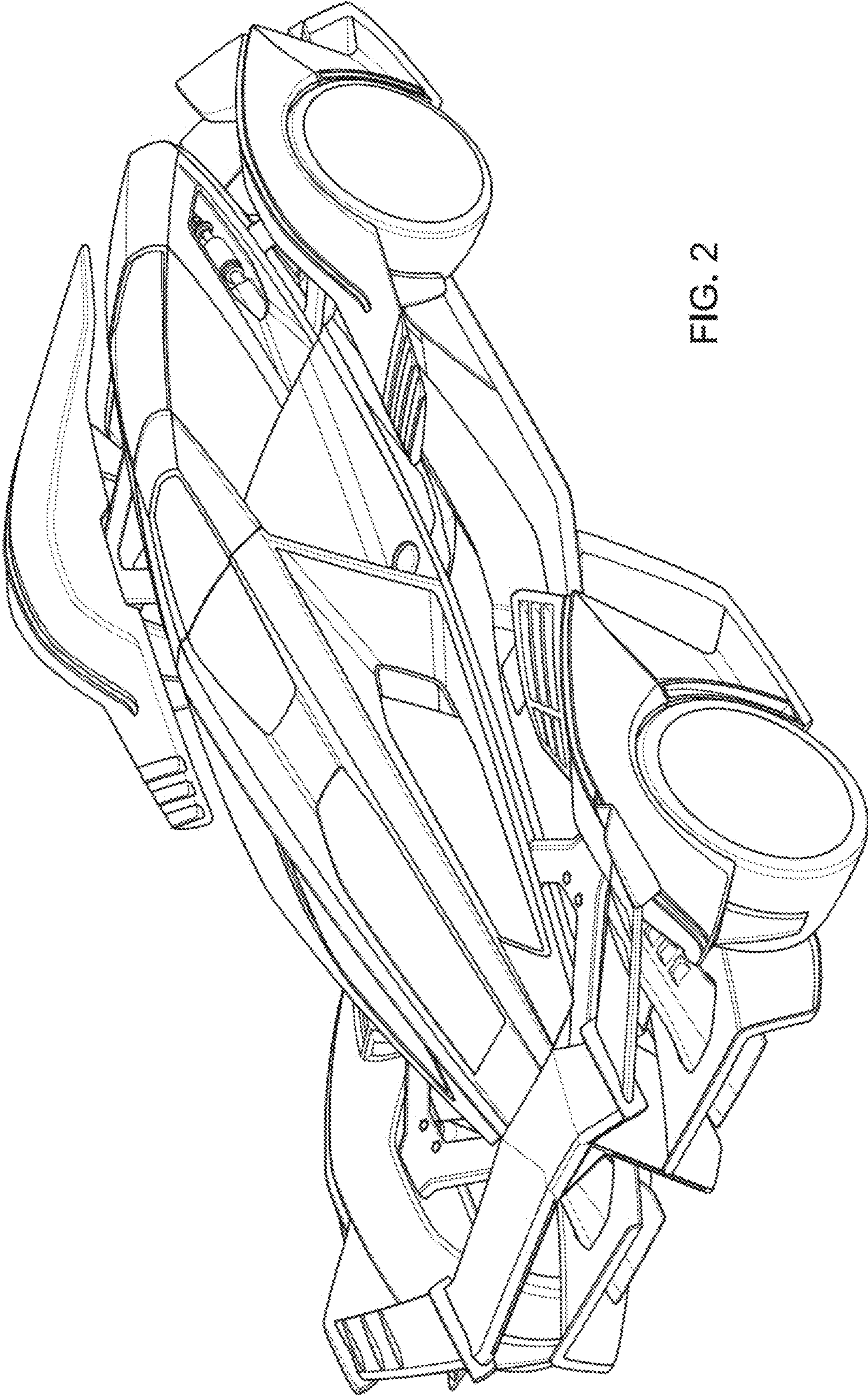

FIG. 2

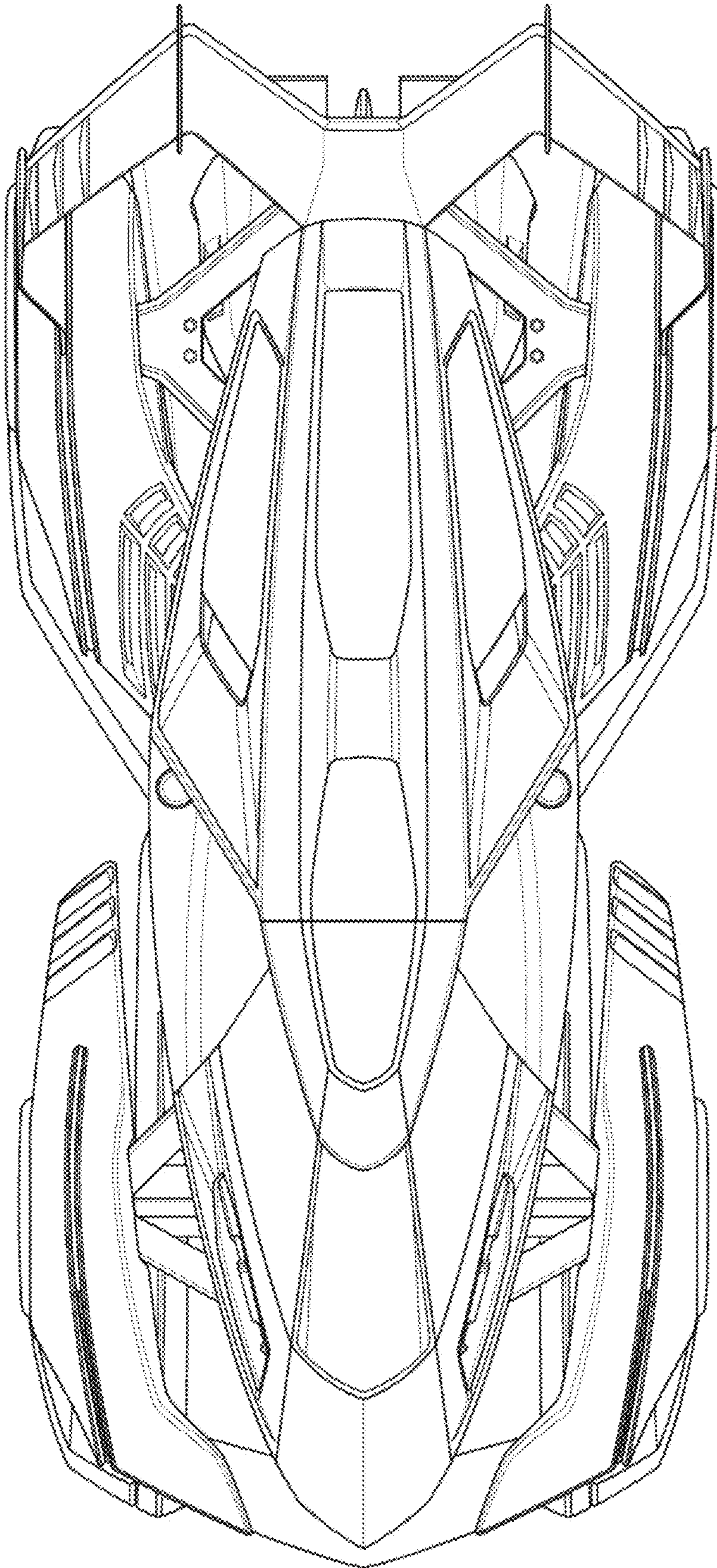

FIG. 3

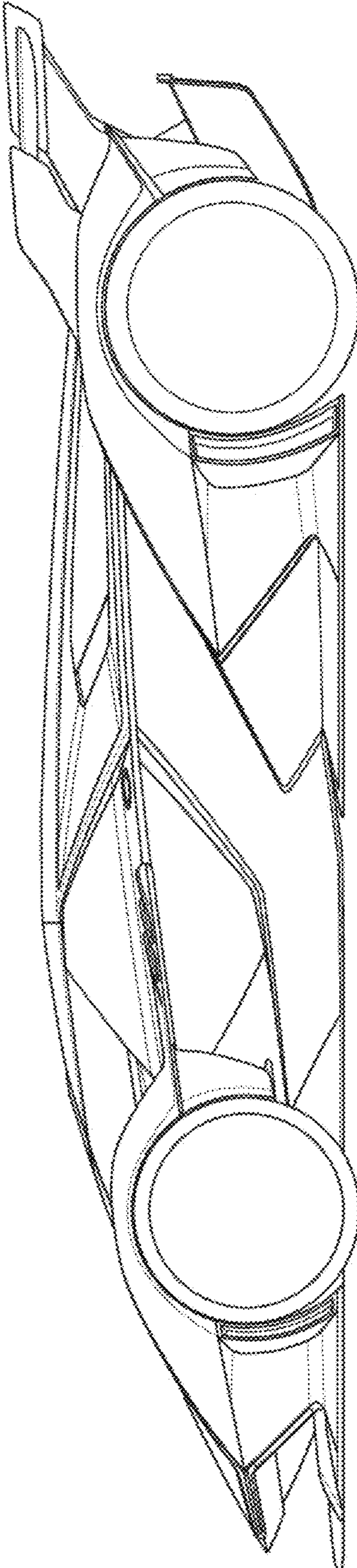

FIG. 4

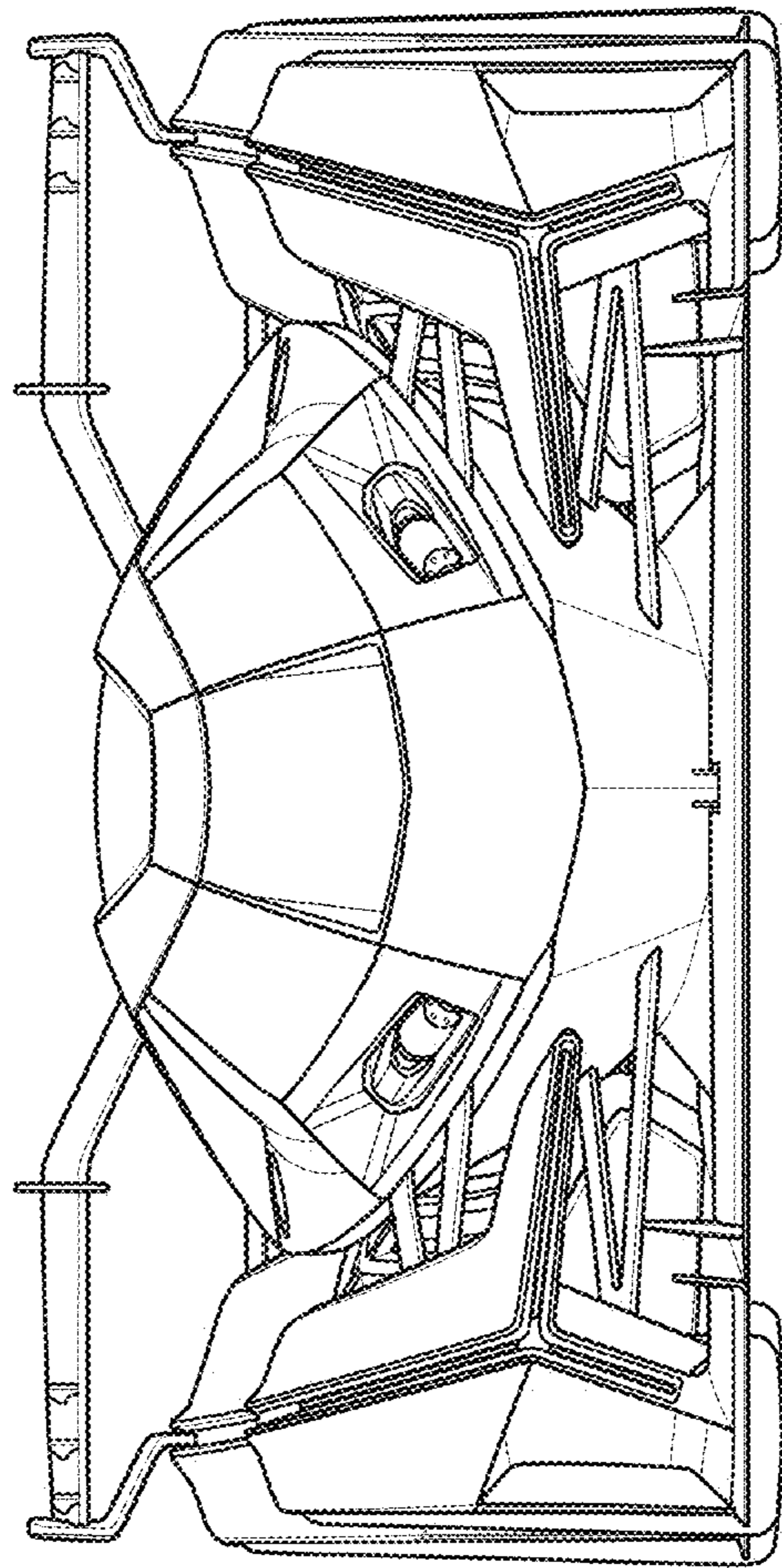

FIG. 5

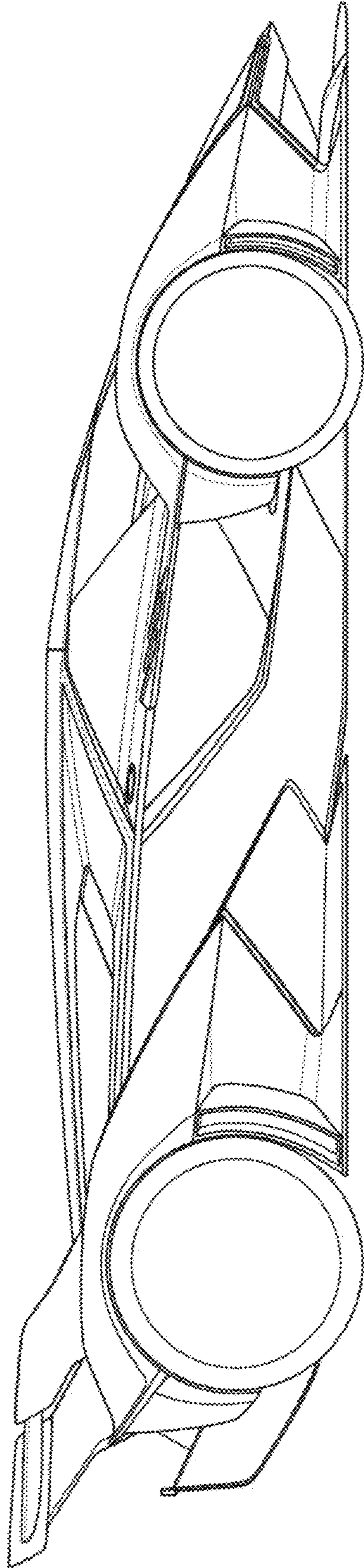

FIG. 6

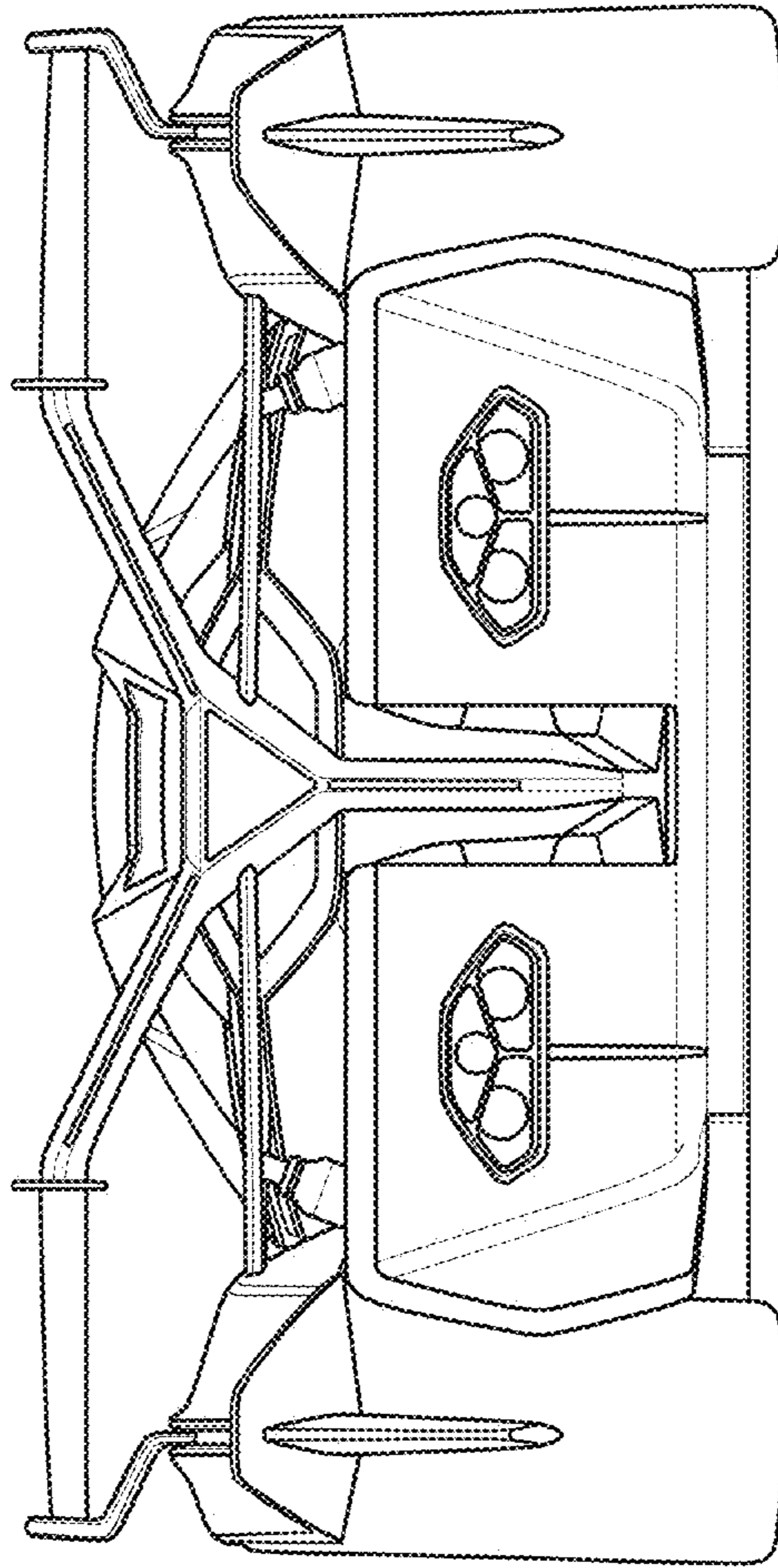

FIG. 7

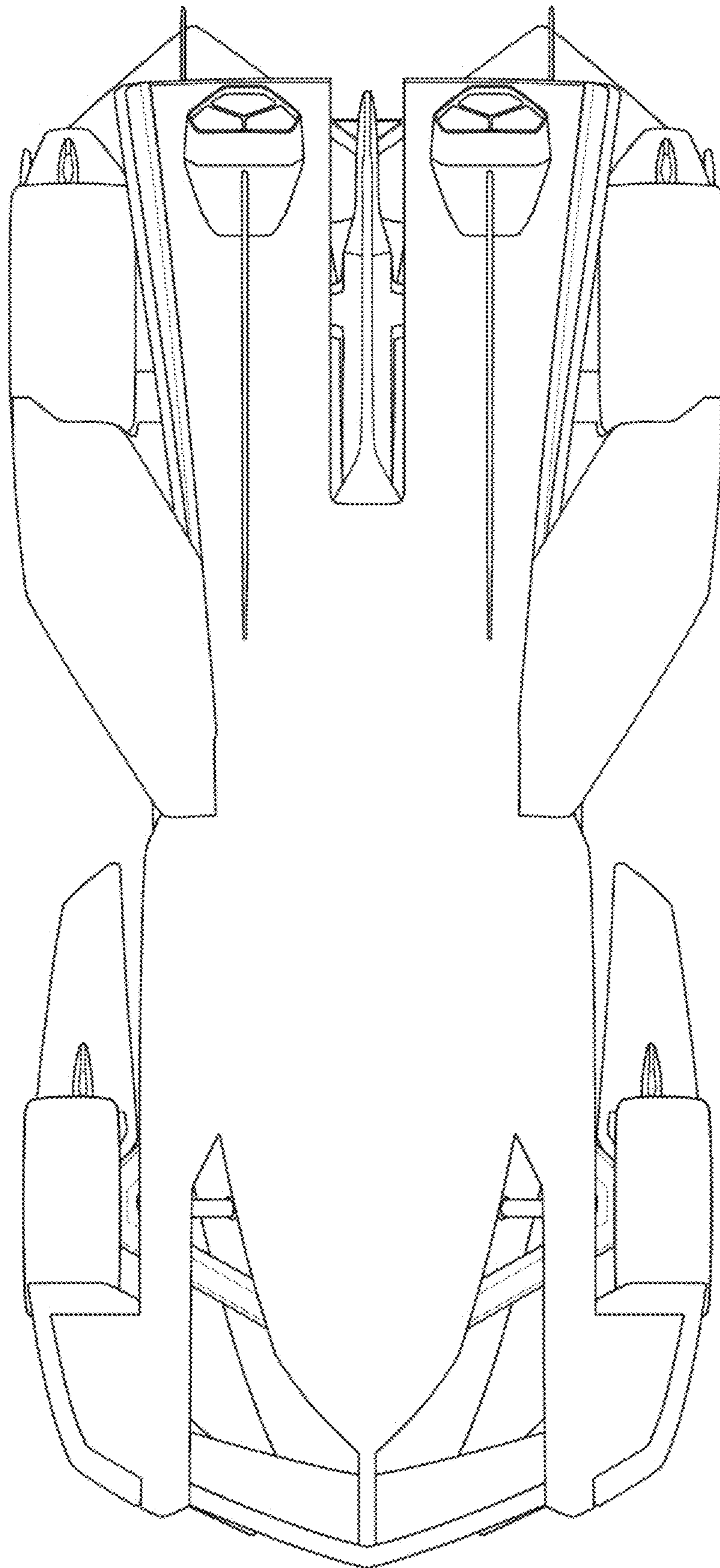

FIG. 8