



US00D952467S

(12) **United States Design Patent**  
**Calderaio**

(10) **Patent No.:** **US D952,467 S**

(45) **Date of Patent:** **\*\* May 24, 2022**

(54) **BOTTLE**

(71) Applicant: **Calderco Holdings Group, LLC,**  
North Palm Beach, FL (US)

(72) Inventor: **John P. Calderaio,** North Palm Beach,  
FL (US)

(73) Assignee: **Calderco Holdings Group, LLC,**  
North Palm Beach, FL (US)

(\*\*) Term: **15 Years**

(21) Appl. No.: **29/711,448**

(22) Filed: **Oct. 31, 2019**

(51) **LOC (13) Cl.** ..... **09-01**

(52) **U.S. Cl.**  
USPC ..... **D9/544; D9/574**

(58) **Field of Classification Search**  
USPC ..... D9/432, 452, 529, 544, 560, 573, 574,  
D9/552, 556, 559, 565, 563, 568, 569;  
D28/8, 76, 85  
CPC ... A45D 40/0068; A45D 40/00; A45D 33/006  
See application file for complete search history.

(56) **References Cited**

**U.S. PATENT DOCUMENTS**

D14,254 S *	9/1883	Heinz	.....	D9/544
D46,285 S *	8/1914	Mackenzie	.....	D9/560
D55,988 S *	8/1920	Dunnook	.....	D9/544
D436,032 S *	1/2001	Croft	.....	D9/416
D444,390 S *	7/2001	Kokenge	.....	D9/542
D466,400 S *	12/2002	Garcia	.....	D9/694
D491,470 S *	6/2004	Yang	.....	D9/544
D564,892 S *	3/2008	di Robilant	.....	D9/544
D580,771 S *	11/2008	Rica	.....	D9/544
D586,659 S *	2/2009	Delbon	.....	D9/544
D596,491 S *	7/2009	Rica	.....	D9/544
D622,601 S *	8/2010	Potts	.....	D9/544
D622,602 S *	8/2010	Potts	.....	D9/544

D622,603 S *	8/2010	Potts	.....	D9/500
D630,100 S *	1/2011	Wanet	.....	D9/544
D653,117 S *	1/2012	Murphy	.....	D9/544
D653,551 S *	2/2012	Murphy	.....	D9/544
D660,169 S *	5/2012	Potts	.....	D9/544
D678,775 S *	3/2013	Daniele	.....	D9/544
D686,081 S *	7/2013	Colangelo	.....	D9/560
D697,416 S *	1/2014	Thompson	.....	D9/544
D698,256 S *	1/2014	Thompson	.....	D9/560
D698,257 S *	1/2014	Gonzalez Rodriguez	.....	D9/574
D714,652 S *	10/2014	Shaw	.....	D9/544
D719,030 S *	12/2014	Perez-Cabrera	.....	D9/560
D741,716 S *	10/2015	Konieczny	.....	D9/544
D742,751 S *	11/2015	Letamendi	.....	D9/560
D745,409 S *	12/2015	Lecetre	.....	D9/574

(Continued)

**FOREIGN PATENT DOCUMENTS**

JP D1478034 \* 8/2013

*Primary Examiner* — Brett Miller

*Assistant Examiner* — Rani J Abdallah

(74) *Attorney, Agent, or Firm* — Breiner & Breiner,  
L.L.C.

(57) **CLAIM**

The ornamental design for bottle, as shown and described.

**DESCRIPTION**

FIG. 1 is a perspective view of the bottle of the invention. FIG. 2 is a front view of the bottle of FIGS. 1 and 7. FIG. 3 is a side view of the bottle of FIGS. 1 and 7. FIG. 4 is a back view of the bottle of FIGS. 1 and 7. FIG. 5 is a top view of the bottle of FIGS. 1 and 7. FIG. 6 is a bottom view of the bottle of FIG. 1. FIG. 7 is a perspective view of another embodiment of the bottle of the invention; and, FIG. 8 is a bottom view of the bottle of FIG. 7. The broken lines in the figures represent portions of the bottle that form no part of the claimed design.

**1 Claim, 7 Drawing Sheets**

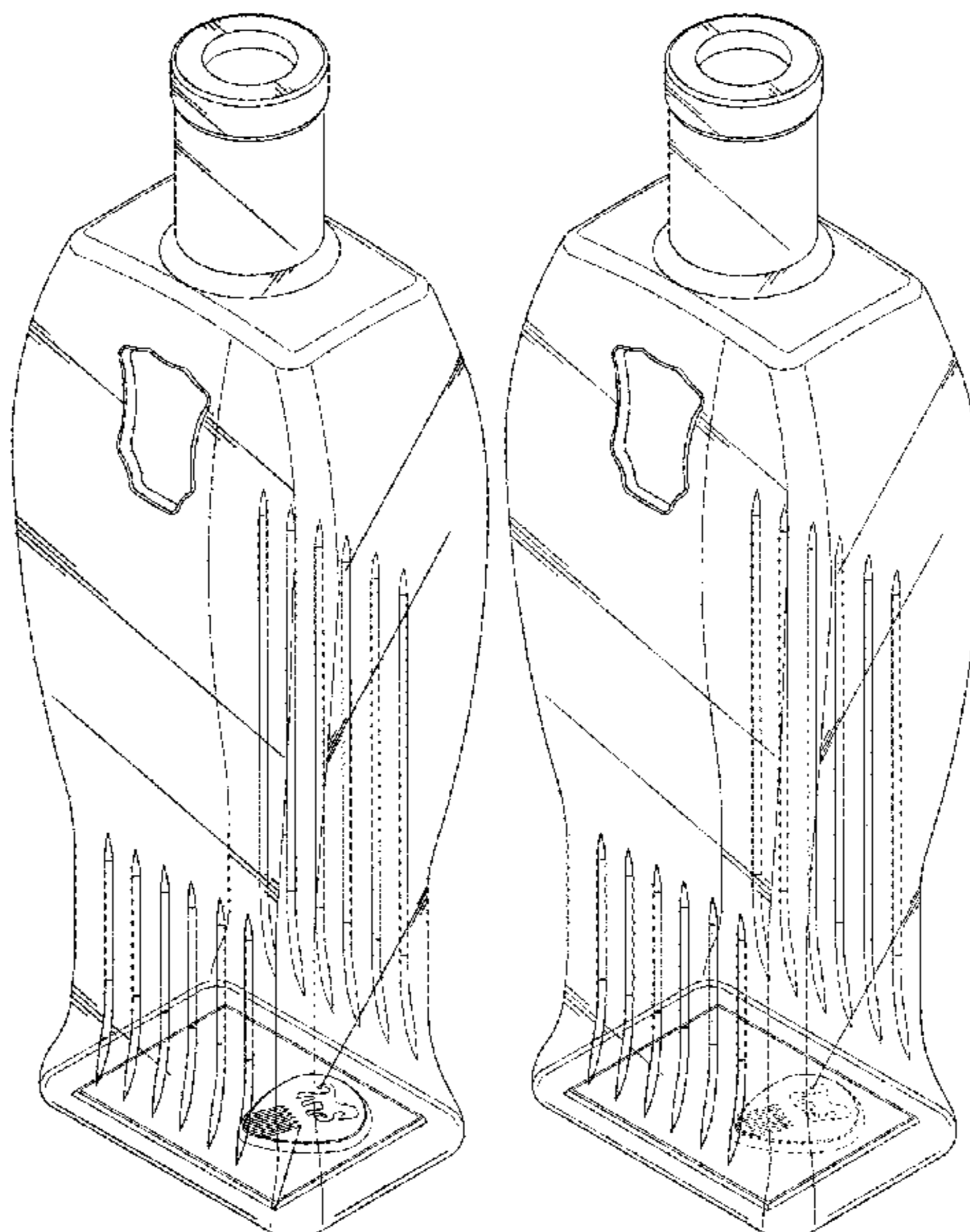

(56)

**References Cited**

U.S. PATENT DOCUMENTS

D770,292 S	*	11/2016	Mullholand .....	D9/544
D798,724 S	*	10/2017	Zelenkov .....	D9/544
D845,783 S	*	4/2019	Nguyen .....	D9/544
D857,512 S	*	8/2019	Vellas .....	D9/544
D857,513 S	*	8/2019	Cannamela .....	D9/574
D915,896 S	*	4/2021	Estrada .....	D9/600

\* cited by examiner

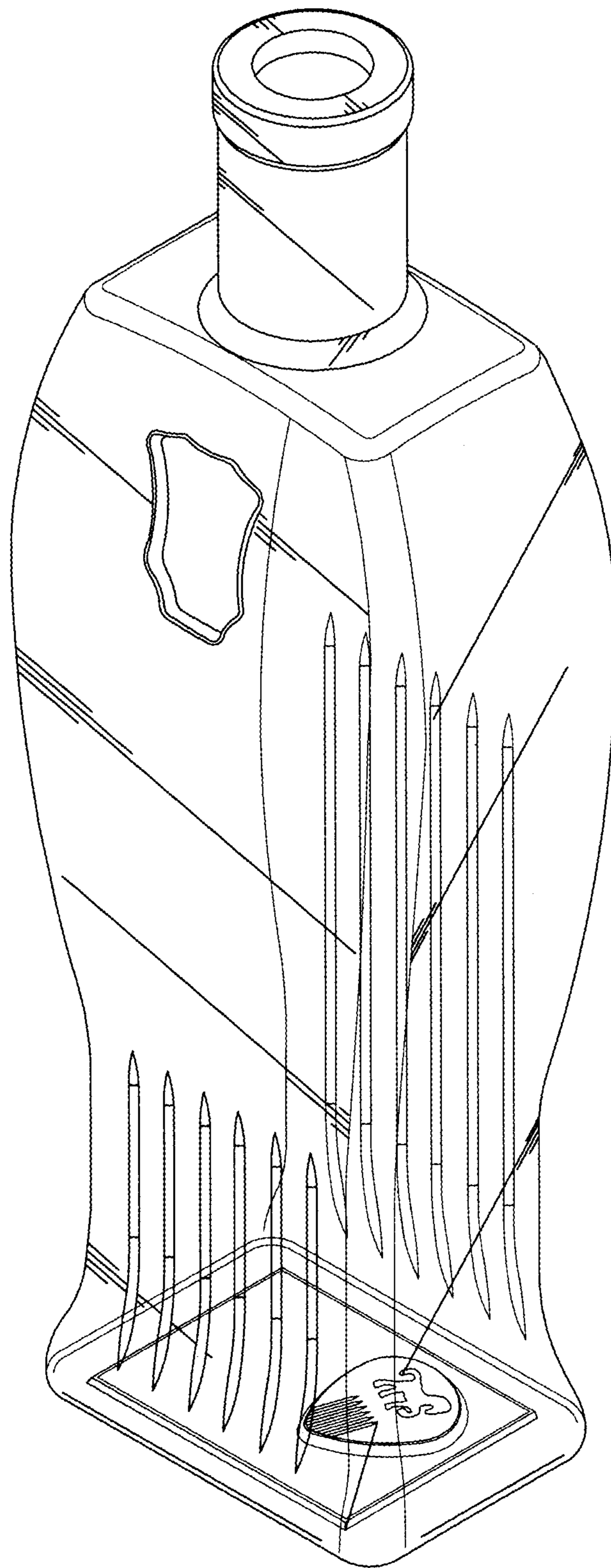
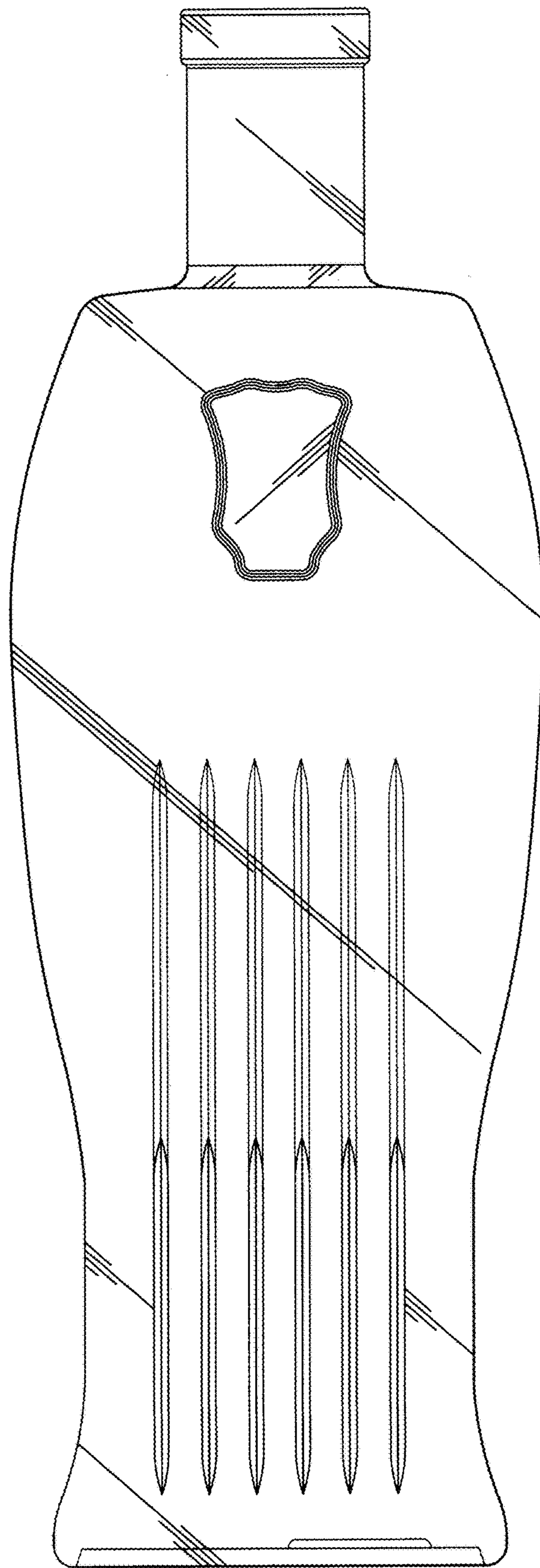
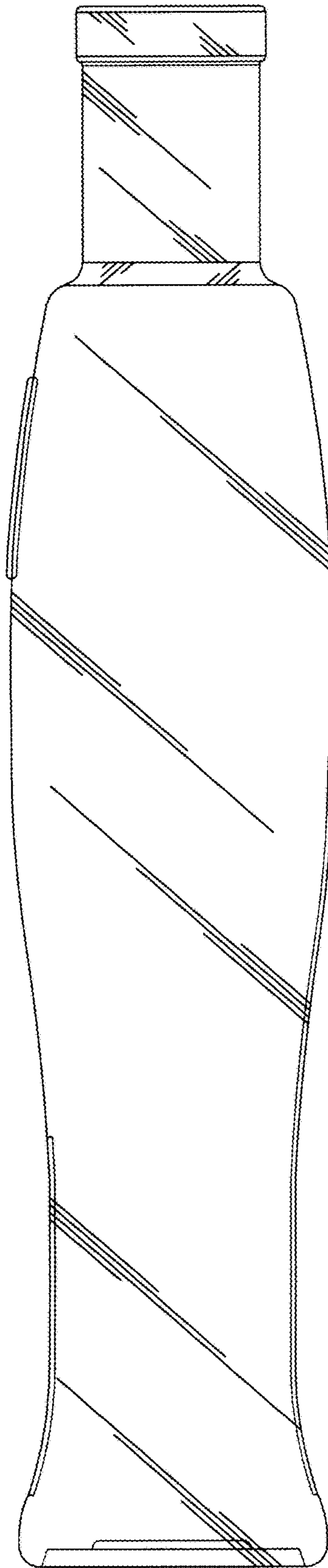

FIG. 1

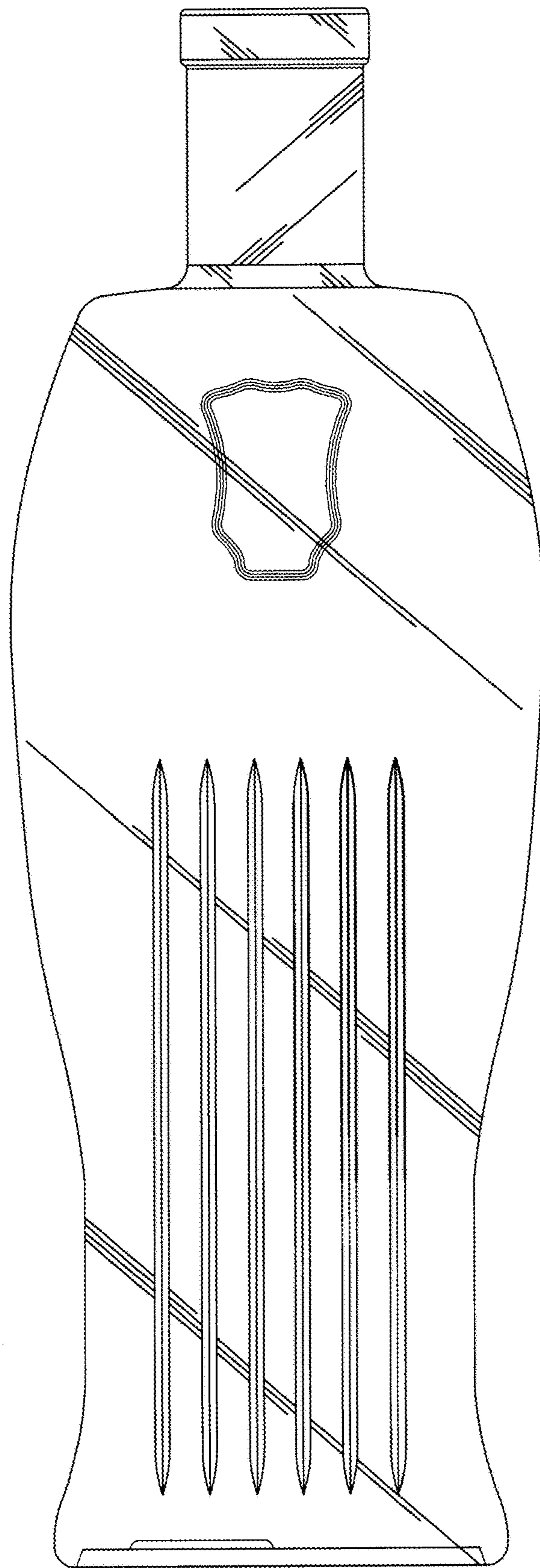

**FIG. 2**

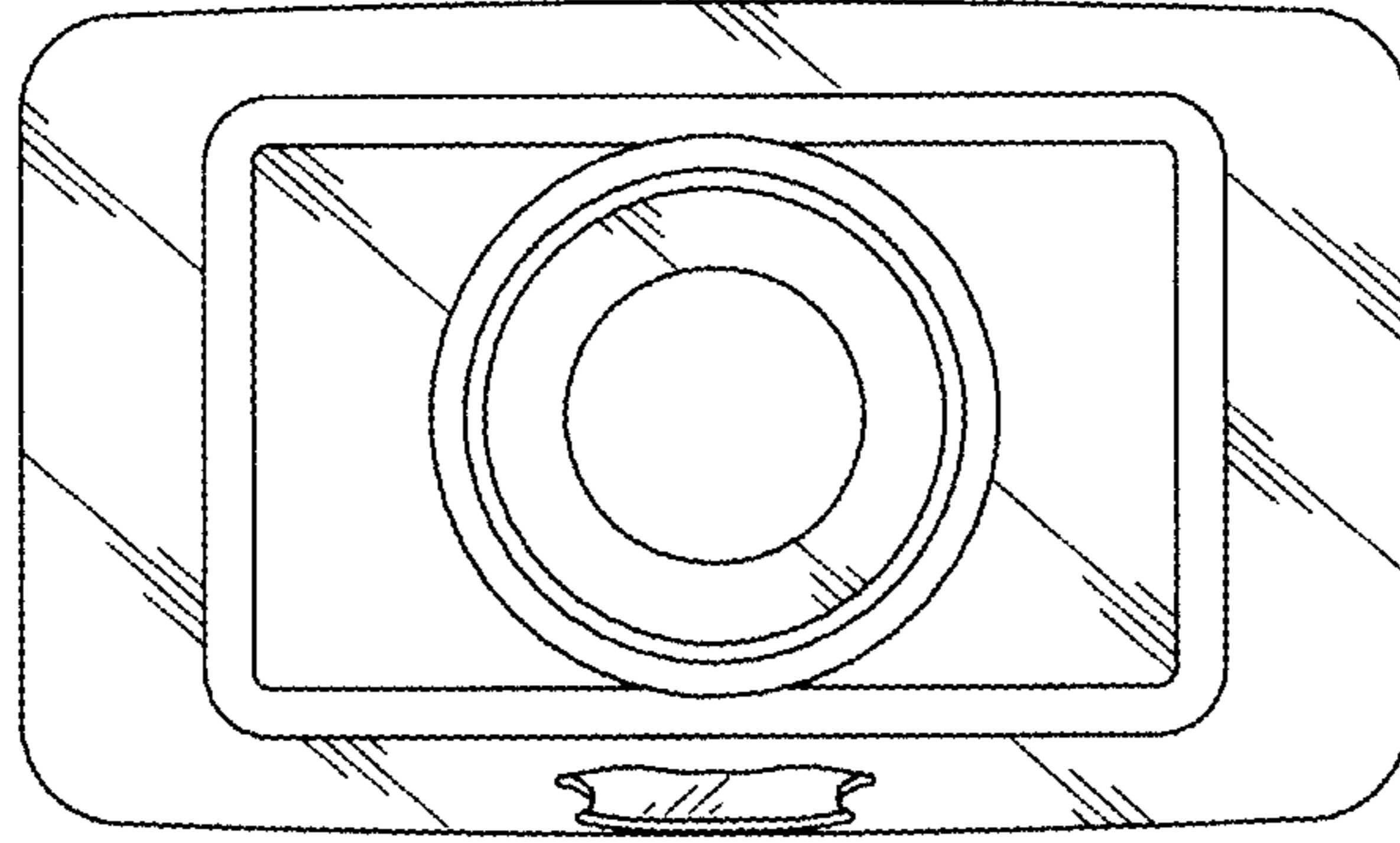



**FIG. 3**



**FIG. 4**



**FIG. 5**

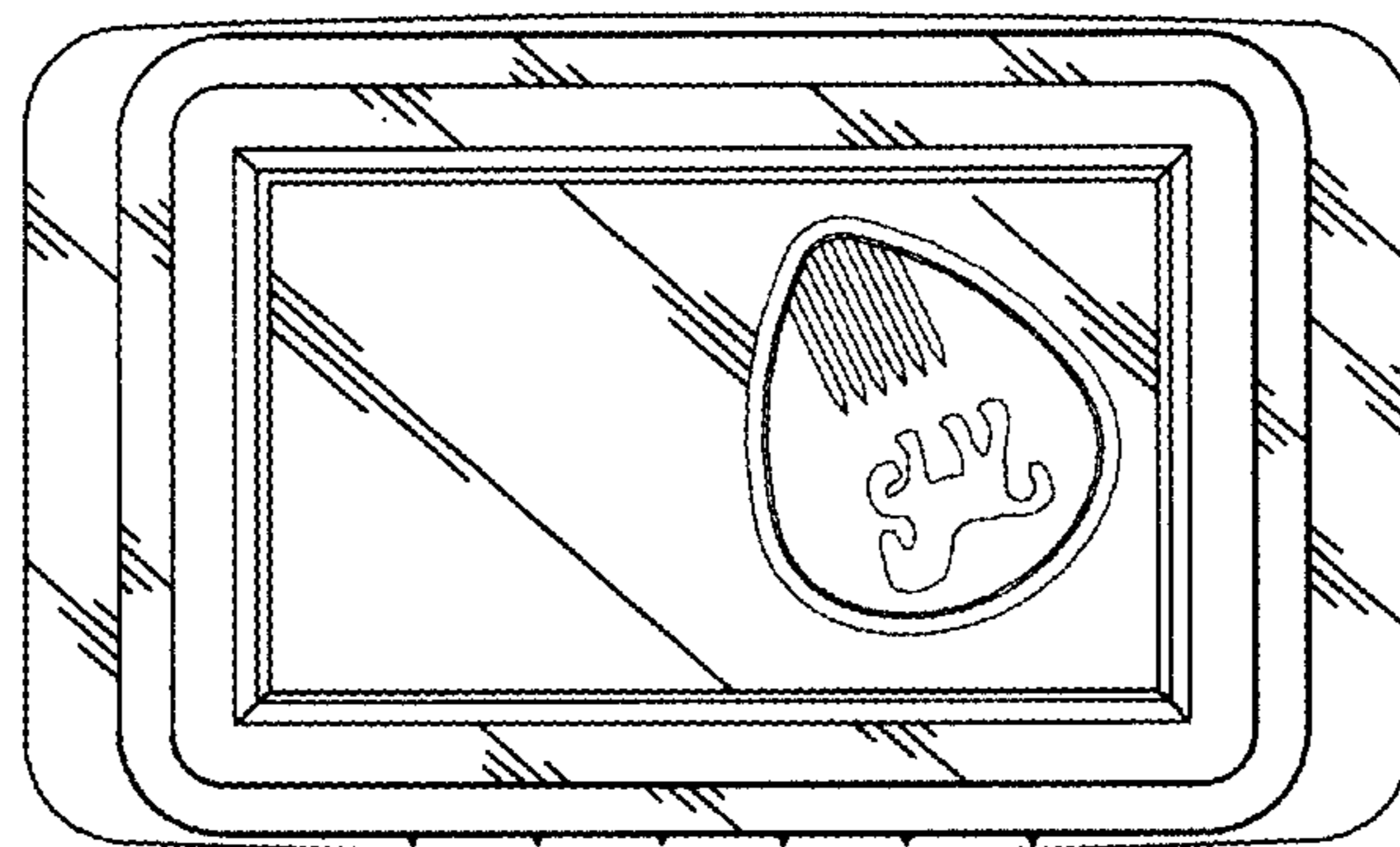

**FIG. 6**

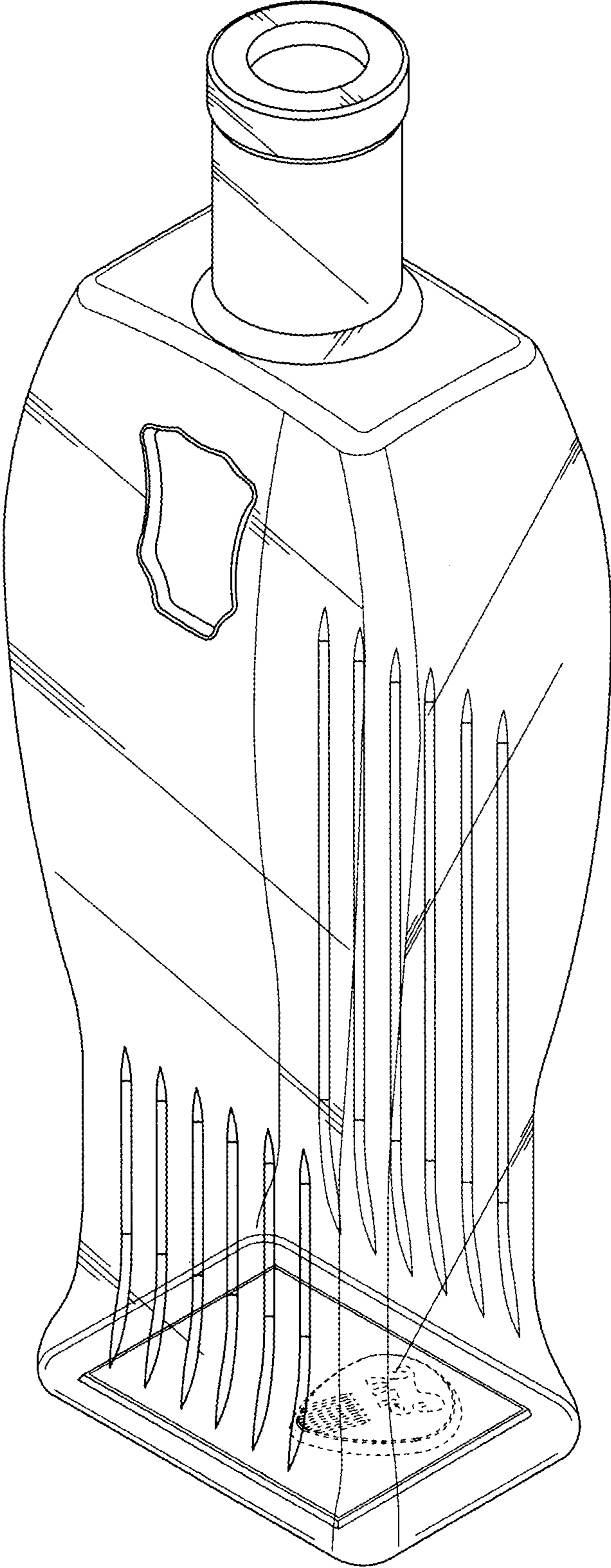
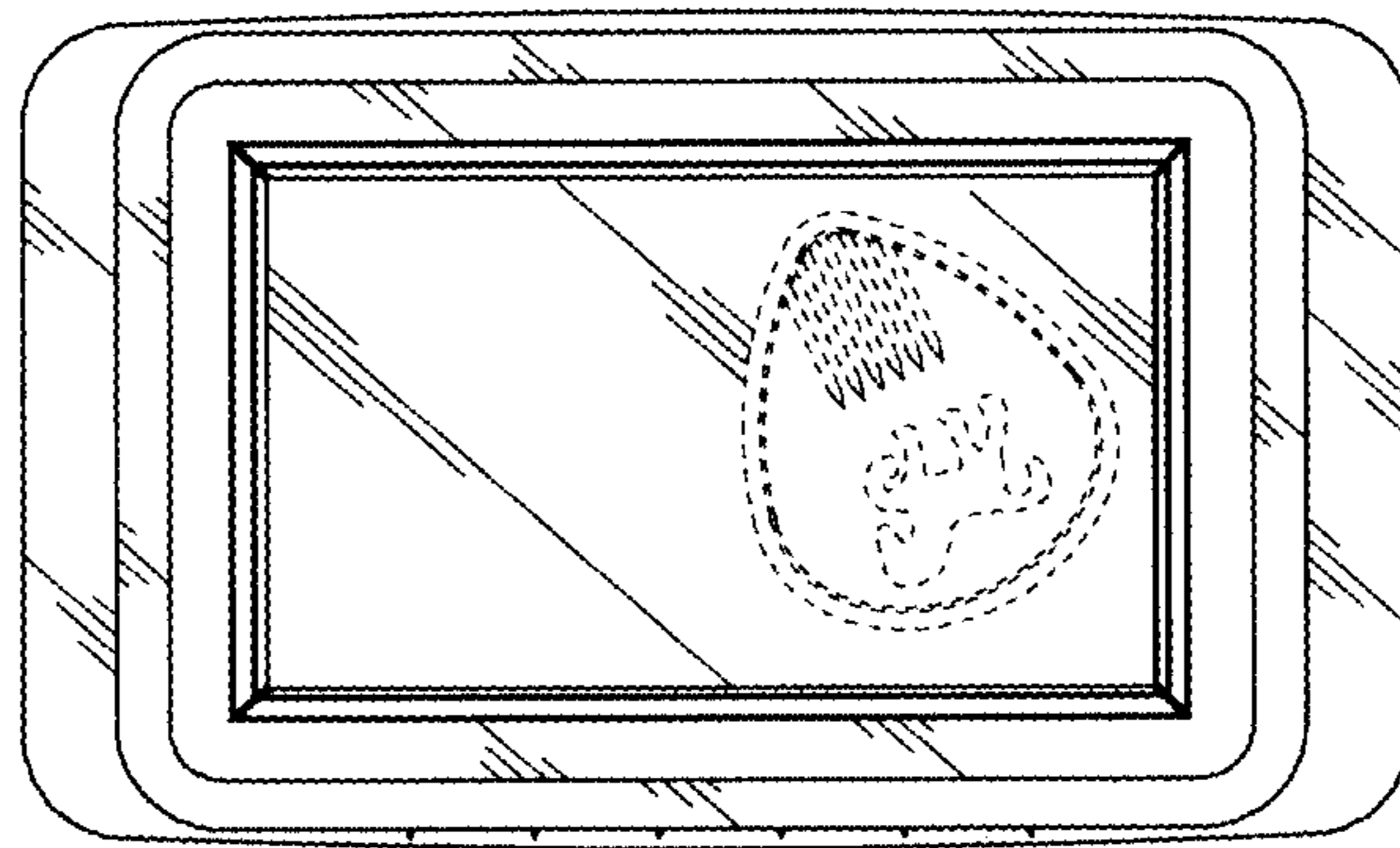

FIG. 7





**FIG. 8**