



US00D952466S

(12) **United States Design Patent** (10) **Patent No.:** **US D952,466 S**
Smith et al. (45) **Date of Patent:** **** May 24, 2022**

- (54) **BOTTLE**
- (71) Applicant: **Cinco Spirits Group, LLC**, New York, NY (US)
- (72) Inventors: **Mark Smith**, Portland, OR (US);
Michael Jordan, Jupiter, FL (US)
- (73) Assignee: **CINCO SPIRITS GROUP, LLC**, New York, NY (US)

D708,011 S	7/2014	Liberatore	
8,783,486 B1	7/2014	Hoyt et al.	
D713,199 S	9/2014	Hannan	
D780,574 S	3/2017	Seeuwen et al.	
D797,500 S	9/2017	Connors	
D818,367 S *	5/2018	Pontes	D9/529
D820,093 S *	6/2018	Pontes	D9/529
D827,365 S	9/2018	Gardner	
D861,490 S *	10/2019	Harter	D9/600
D867,132 S	11/2019	Callaars	
D885,040 S	5/2020	Pashandi	

- (**) Term: **15 Years**
- (21) Appl. No.: **29/743,222**
- (22) Filed: **Jul. 20, 2020**
- (51) **LOC (13) Cl.** **09-01**
- (52) **U.S. Cl.**
USPC **D9/523**; D9/544; D9/575
- (58) **Field of Classification Search**
USPC D9/434-435, 439, 516, 520, 522-523,
D9/544, 559, 575, 682, 694, 715, 719
CPC B65D 1/00; B65D 1/02; B65D 1/0223;
B65D 23/00; B65D 51/32; B65D
2501/00; B65D 2501/0009; B65D
2501/0081
See application file for complete search history.

- (56) **References Cited**
U.S. PATENT DOCUMENTS
D177,774 S 5/1956 Stroup
D318,232 S 7/1991 Mansau
D429,633 S * 8/2000 Godio D7/598
D612,736 S * 3/2010 Pecora D9/522
D633,753 S 3/2011 White
D673,856 S * 1/2013 Snyder D9/522
D677,525 S 3/2013 Luebke
D681,469 S * 5/2013 Mishan D9/522
D684,863 S * 6/2013 Snyder D9/522
D699,117 S * 2/2014 Snyder D9/522

OTHER PUBLICATIONS

Non-Final Office Action issued in U.S. Appl. No. 29/743,215 dated Aug. 4, 2021.
Notice of Allowance issued in counterpart UAE Design Application Serial No. 6000064 dated Sep. 5, 2021.
(Continued)

Primary Examiner — Dana Meyrow
(74) *Attorney, Agent, or Firm* — Brian J. Colandreo;
Jeffrey T. Placker; Holland & Knight LLP

(57) **CLAIM**

The ornamental design for a bottle, as shown and described.

DESCRIPTION

FIG. 1 is a perspective view of a bottle;
FIG. 2 is a second perspective view thereof;
FIG. 3 is a third perspective view thereof;
FIG. 4 is a rear elevation view thereof;
FIG. 5 is a right elevation view thereof;
FIG. 6 is a front elevation view thereof;
FIG. 7 is a left elevation view thereof;
FIG. 8 is top plan view thereof; and,
FIG. 9 is a bottom plan view thereof.
The broken lines indicate features of the bottle design that do not form part of the claimed design.

1 Claim, 8 Drawing Sheets

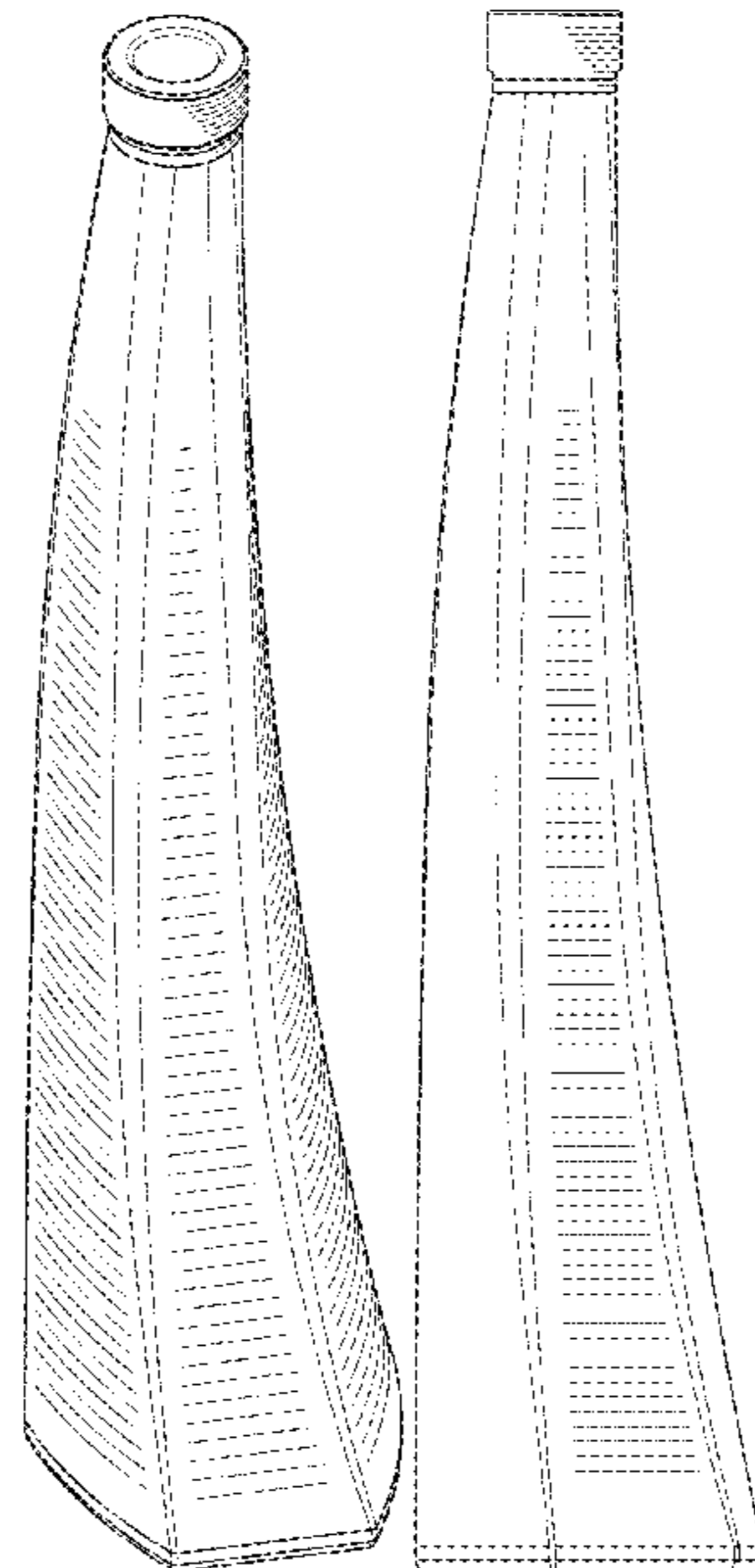

(56)

References Cited

OTHER PUBLICATIONS

Office of Allowance issued in counterpart UAE Design Application Serial No. 6000065 dated Sep. 5, 2021.

Examination Report No. 1 issued in counterpart Australian Design Application Serial No. 202110164 dated May 25, 2021.

Examination Report No. 1 issued in counterpart Australian Design Application Serial No. 303220143 dated May 25, 2021.

Office Action issued in counterpart Brazilian Design Application Serial No. 3020210002094 dated Jun. 28, 2021.

Office Action issued in counterpart Brazilian Design Application Serial No. 3020210002086 dated Jun. 6, 2021.

Notice of Allowance issued in counterpart Design U.S. Appl. No. 29/743,223 dated Nov. 15, 2021.

Notice of Allowance issued in U.S. Appl. No. 29/743,215 dated Jan. 12, 2022.

Notice of Allowance issued in counterpart Design U.S. Appl. No. 29/743,223 dated Mar. 2, 2022.

Unknown, Tequila Brand Cincoro: Announced Sep. 16, 2019 [online] Retrieved from the Internet URL: <https://www.forbes.com/sites/chloesorvino/2019/09/16/the-inside-story-of-how-michael-jordan-and-four-nba-owners-launched-the-super-premium-tequila-brand-cincoro/?sh=5cc1c3773aa>.

* cited by examiner

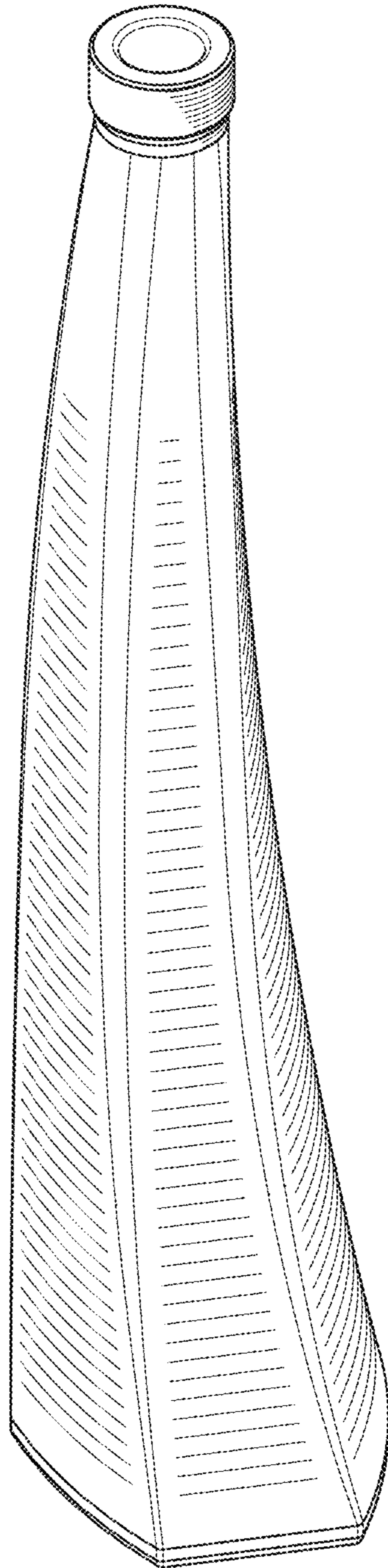

FIG. 1

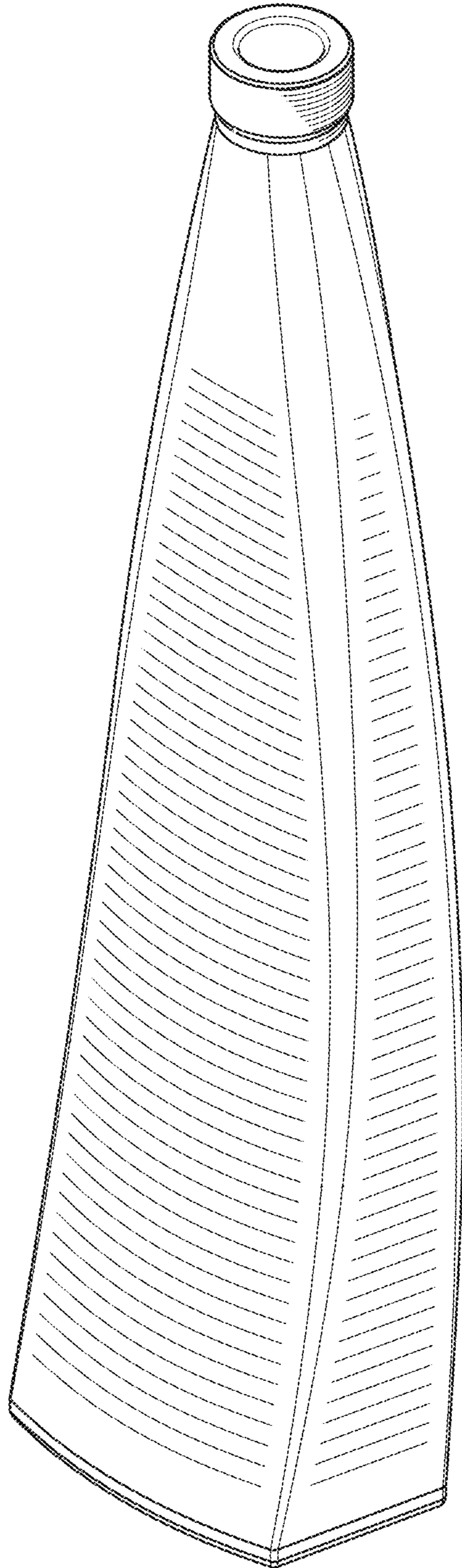

FIG. 2

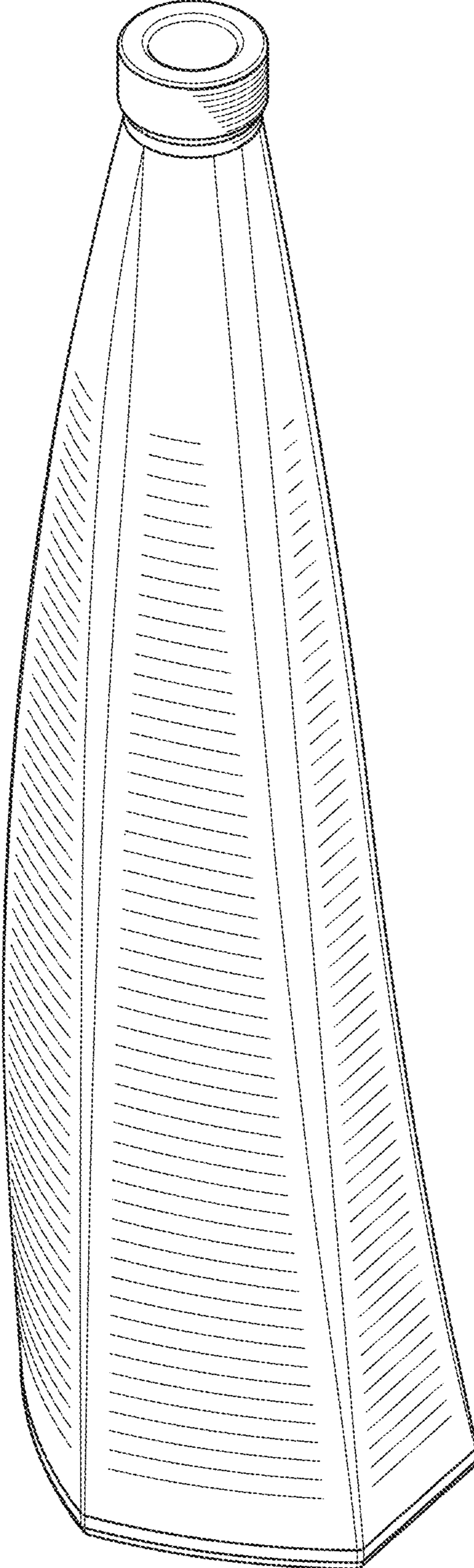

FIG. 3

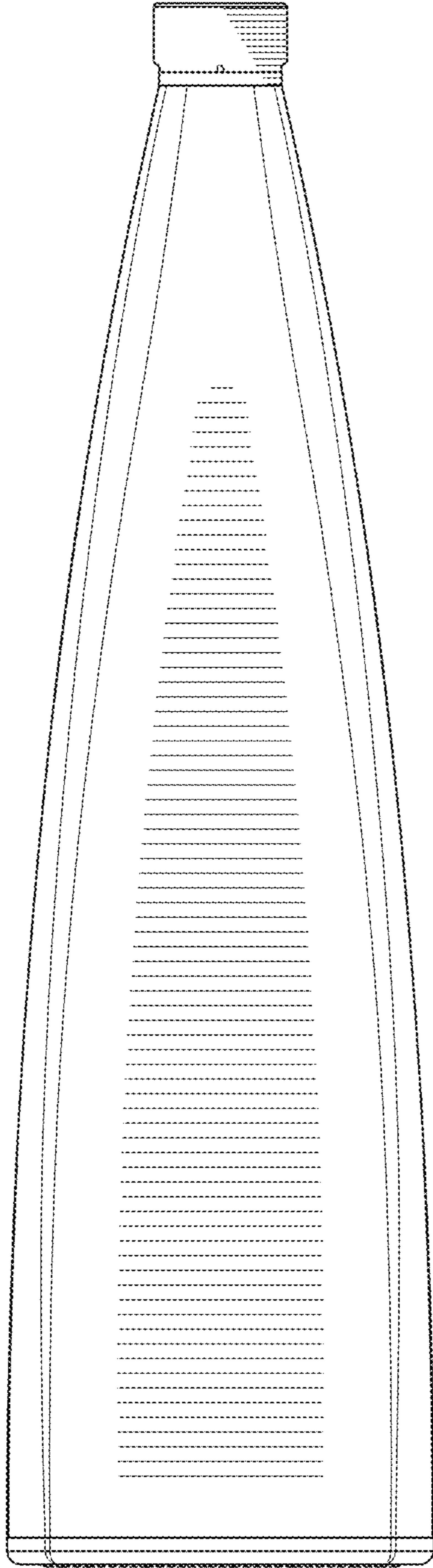

FIG. 4

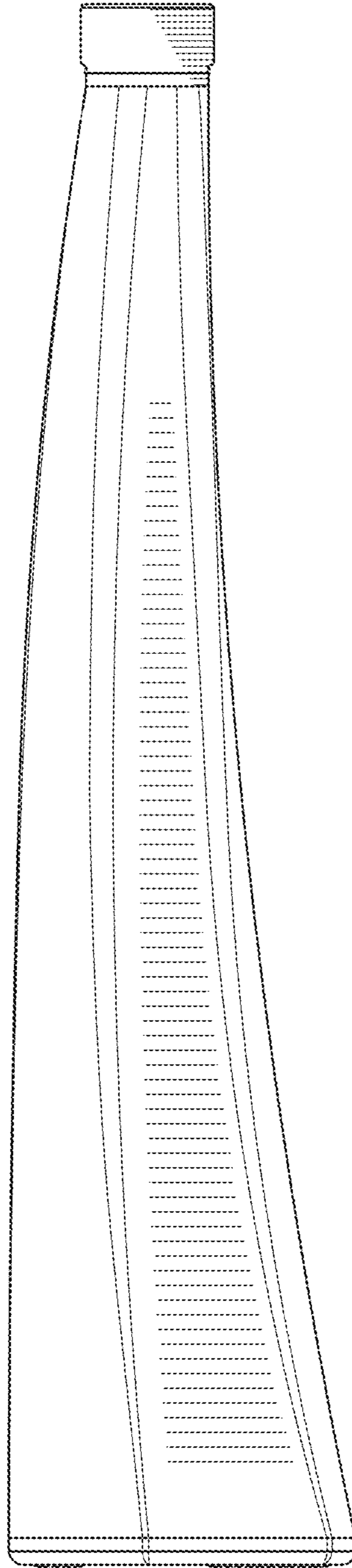

FIG. 5

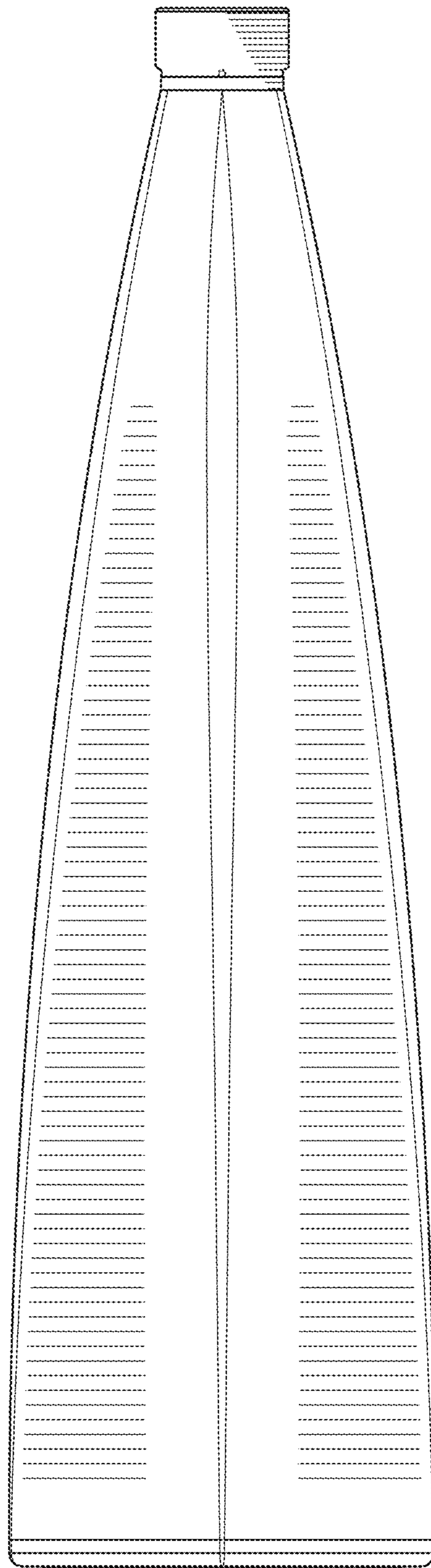

FIG. 6

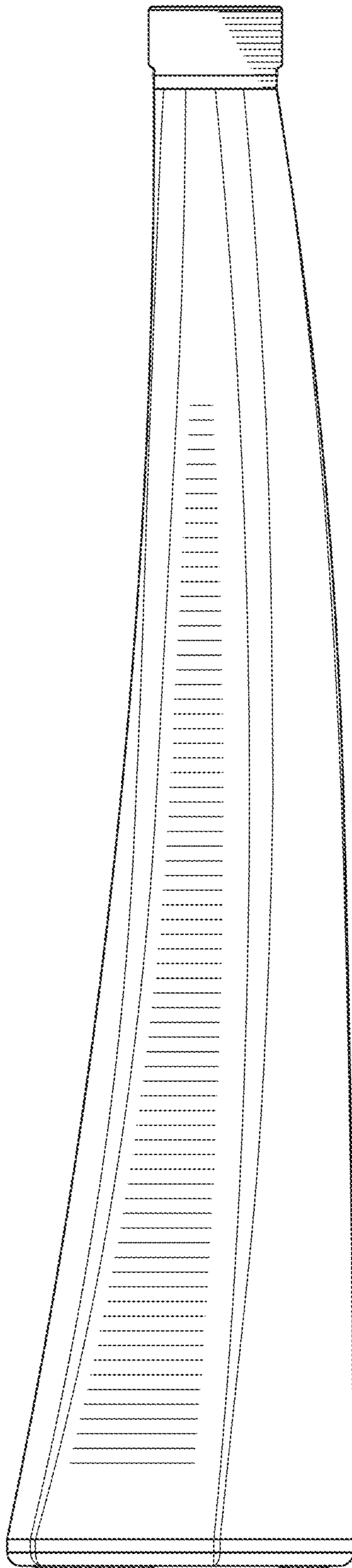

FIG. 7

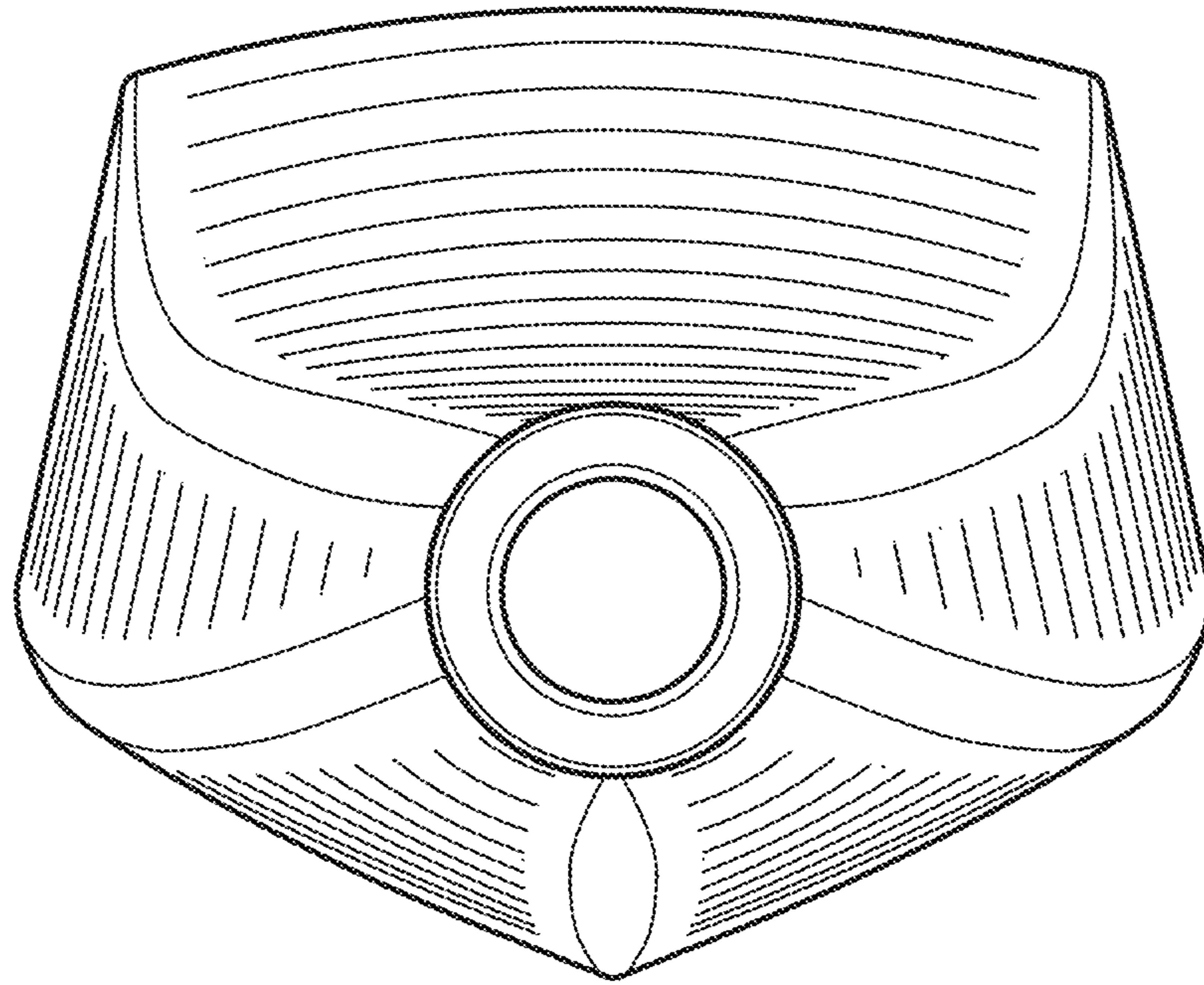

FIG. 8

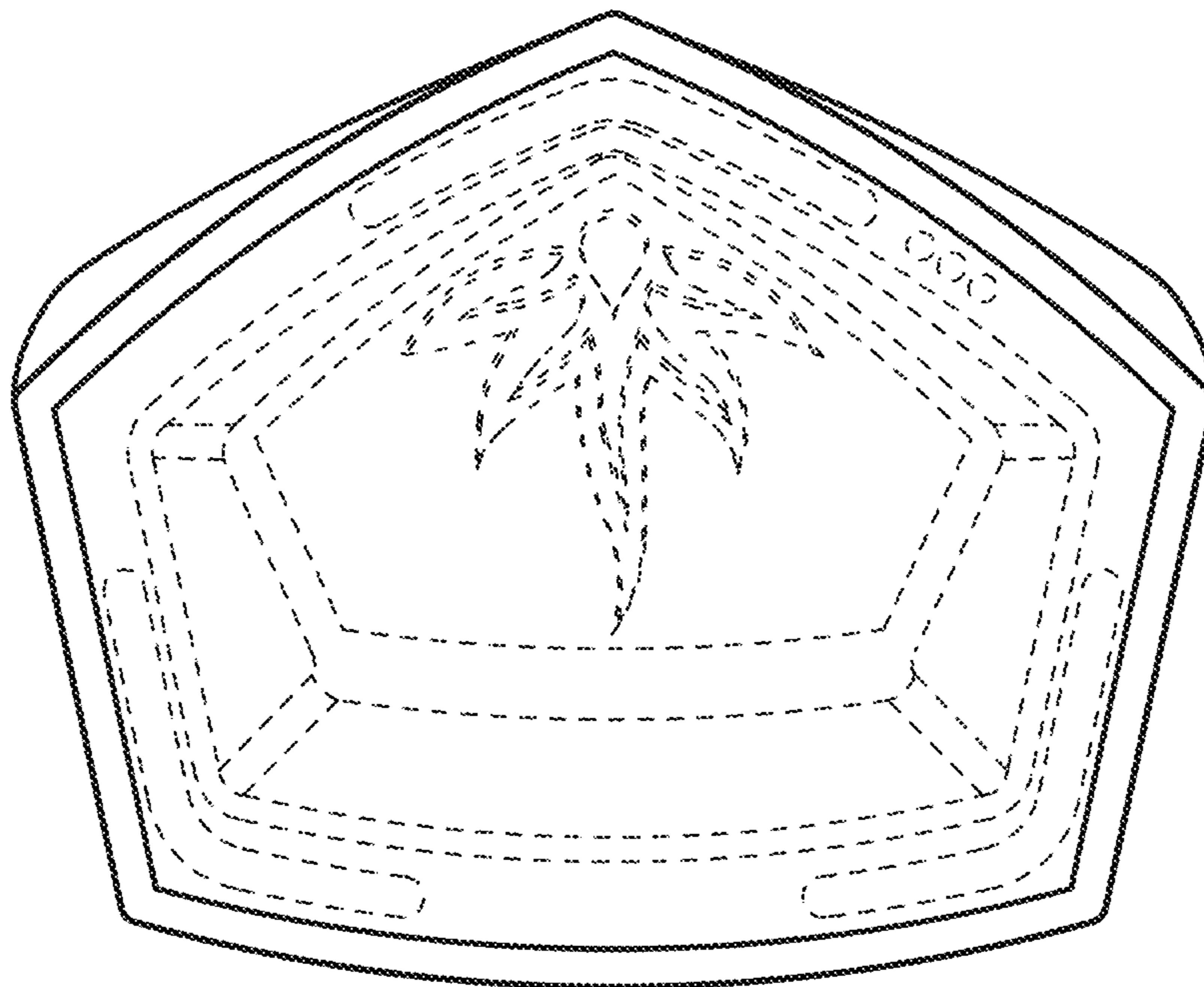

FIG. 9