



US00D952455S

(12) **United States Design Patent**
Sill et al.

(10) **Patent No.:** **US D952,455 S**

(45) **Date of Patent:** **** *May 24, 2022**

(54) **CARTON**

(71) Applicant: **Inno-Pak, LLC**, Delaware, OH (US)

(72) Inventors: **Jonathan D. Sill**, Delaware, OH (US);
Steven A. Mayer, Indianapolis, IN (US)

(73) Assignee: **Inno-Pak, LLC**, Delaware, OH (US)

(*) Notice: This patent is subject to a terminal disclaimer.

(**) Term: **15 Years**

(21) Appl. No.: **29/722,929**

(22) Filed: **Feb. 3, 2020**

Related U.S. Application Data

(62) Division of application No. 29/655,771, filed on Jul. 6, 2018, now Pat. No. Des. 891,919.

(51) **LOC (13) Cl.** **09-03**

(52) **U.S. Cl.**
USPC **D9/418; D9/737**

(58) **Field of Classification Search**
USPC D9/414-423, 424-429, 430-433, 434,
D9/456, 457, 711, 713, 721-722, 737,
(Continued)

(56) **References Cited**

U.S. PATENT DOCUMENTS

2,222,211 A 11/1940 Arneson
D182,375 S 3/1958 Moore
(Continued)

OTHER PUBLICATIONS

Paper Window Sushi Boxes Packaging Mockup. [online] Retrieved Dec. 16, 2020 from URL: <https://elements.envato.com/paper-window-sushi-boxes-packaging-mockup-C8XJ8Z7>.*

(Continued)

Primary Examiner — Vy N Koenig

(74) *Attorney, Agent, or Firm* — Ward and Smith, P.A.;
Ryan K. Simmons

(57) **CLAIM**

The ornamental design for a carton, as shown and described.

DESCRIPTION

FIG. 1 is a front perspective view of a carton showing the new design;
FIG. 2 is a rear perspective view thereof;
FIG. 3 is a front elevation view thereof;
FIG. 4 is a rear elevation view thereof;
FIG. 5 is a right side elevation view thereof;
FIG. 6 is a left side elevation view thereof;
FIG. 7 is a top plan view thereof;
FIG. 8 is bottom plan view thereof;
FIG. 9 is another front perspective view of the carton of FIG. 1 shown in an open configuration;
FIG. 10 is a front elevation view thereof;
FIG. 11 is a rear elevation view thereof;
FIG. 12 is a right side elevation view thereof;
FIG. 13 is a left side elevation view thereof;
FIG. 14 is a top plan view thereof;
FIG. 15 is bottom plan view thereof;
FIG. 16 is another top plan view of the carton of FIG. 9 showing an alternate embodiment;
FIG. 17 is another bottom plan view of the carton of FIG. 9 showing an alternate embodiment;
FIG. 18 is another front perspective view of the carton of FIG. 1 shown in an alternate configuration;
FIG. 19 is a rear perspective view thereof;
FIG. 20 is a front elevation view thereof;
FIG. 21 is a rear elevation view thereof;
FIG. 22 is a right side elevation view thereof;
FIG. 23 is a left side elevation view thereof;
FIG. 24 is a top plan view thereof;
FIG. 25 is bottom plan view thereof;
FIG. 26 is another perspective view of the carton of FIG. 18 showing a portion of an unclaimed container housed therein;
FIG. 27 is another front perspective view of the carton of FIG. 18 shown in an open configuration;
FIG. 28 is a front elevation view thereof;

(Continued)

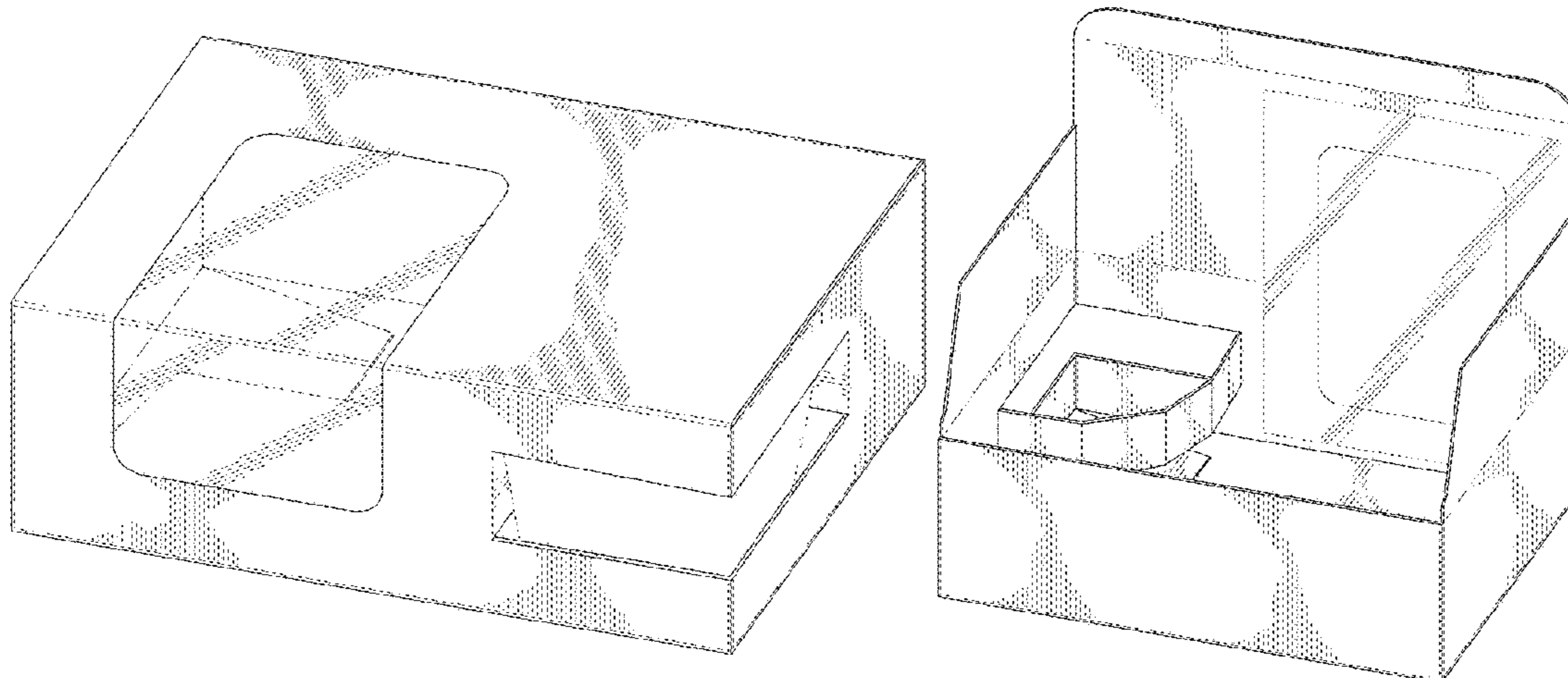

FIG. 29 is a rear elevation view thereof;
 FIG. 30 is a right side elevation view thereof;
 FIG. 31 is a left side elevation view thereof;
 FIG. 32 is a top plan view thereof;
 FIG. 33 is bottom plan view thereof;
 FIG. 34 is another top plan view of the carton of FIG. 27 showing an alternate embodiment;
 FIG. 35 is another bottom plan view of the carton of FIG. 27 showing an alternate embodiment; and,
 FIG. 36 is another perspective view of the carton of FIG. 27 showing a portion of an unclaimed container housed therein. In the Figures, the dash-dash broken lines are for the purpose of illustrating environment and form no part of the claimed design, and the dot dot lines illustrate perforations and form part of the claimed design.

1 Claim, 30 Drawing Sheets

(58) **Field of Classification Search**

USPC D9/756, 758, 759, 760; D3/272-274;
 D20/10, 22, 27, 40, 42
 CPC ... B65D 5/00; B65D 5/02; B65D 5/18; B65D
 5/20

See application file for complete search history.

(56) **References Cited**

U.S. PATENT DOCUMENTS

D242,901 S	1/1977	Lohrbach
D259,175 S	5/1981	Austin, Jr.
4,601,390 A	7/1986	Rosenthal et al.
D346,738 S	5/1994	Kinigakis
5,392,984 A	2/1995	Yocum
6,036,085 A	3/2000	Tsao
D446,448 S	8/2001	Jernigan et al.
D466,406 S	12/2002	Solland
D466,804 S	12/2002	Solland
D488,062 S	4/2004	Shannon
D567,079 S	4/2008	Fant

D576,482 S	9/2008	DeBusk	
D600,547 S	9/2009	Cain	
D630,503 S	1/2011	Abdalkhani et al.	
D679,950 S	4/2013	Cooper	
D689,360 S *	9/2013	Adams	D9/418
D702,546 S	4/2014	McAdam	
D744,825 S	12/2015	Johansen	
D789,783 S	6/2017	DeBusk	
D795,687 S	8/2017	Pollock	
D798,142 S	9/2017	Falcon et al.	
D835,982 S	12/2018	Mayer	
D845,760 S	4/2019	Oliveira	
D846,982 S	4/2019	Horne	
10,322,840 B2	6/2019	Angulo et al.	
D855,453 S	8/2019	Meyer et al.	
D863,950 S	10/2019	Chilton	
D867,125 S	11/2019	Sill et al.	
D879,603 S *	3/2020	Sill	D9/418
D879,606 S *	3/2020	Sill	D9/432
D880,999 S *	4/2020	Sill	D9/418
D881,001 S *	4/2020	Sill	D9/418
D881,002 S *	4/2020	Sill	D9/418
D891,920 S *	8/2020	Sill	D9/432
2009/0236351 A1 *	9/2009	Chu	B65D 25/22 220/751
2012/0125988 A1 *	5/2012	Seabaugh	B65D 5/0005 229/126
2019/0144157 A1 *	5/2019	Sill	B65D 5/4204 206/459.1

OTHER PUBLICATIONS

Amazon, "Paperboard 4 Corner 11"x6³/₄"x2³/₄" Food and Drink Stadium/Theater Strap Tray/Carrier or Holder by MTProducts (15 Pieces)", Available at <https://www.amazon.com/Paperboard-Stadium-Theater-MT-Products/dp/B074MLNQQ2>, accessed on Aug. 1, 2019, 06 pages.
 Fresh Flavor Carry Out, 2018 Inna-Pak online catalogue, www.innopak.com, p. 5.
 Sink Paper and Packaging, "02051-300 4-Cup Drink Carrier Handled Field Cont. 200/case", Available at <https://ddi.sinkpaper.com/productdetail2.aspx?dataid=888-02051-300>, Accessed on Jul. 23, 2019, 01 page.

* cited by examiner

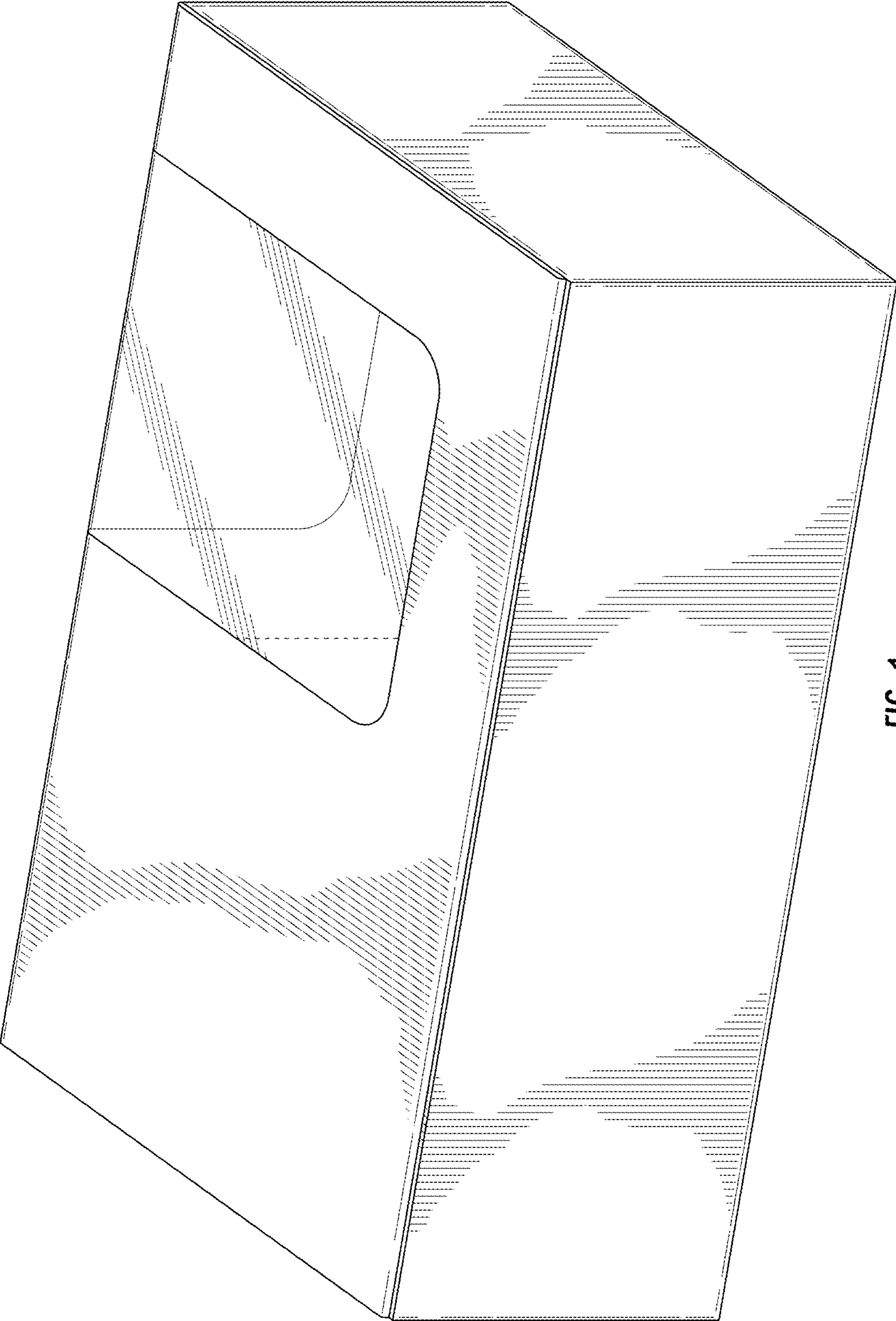

FIG. 1



FIG. 2

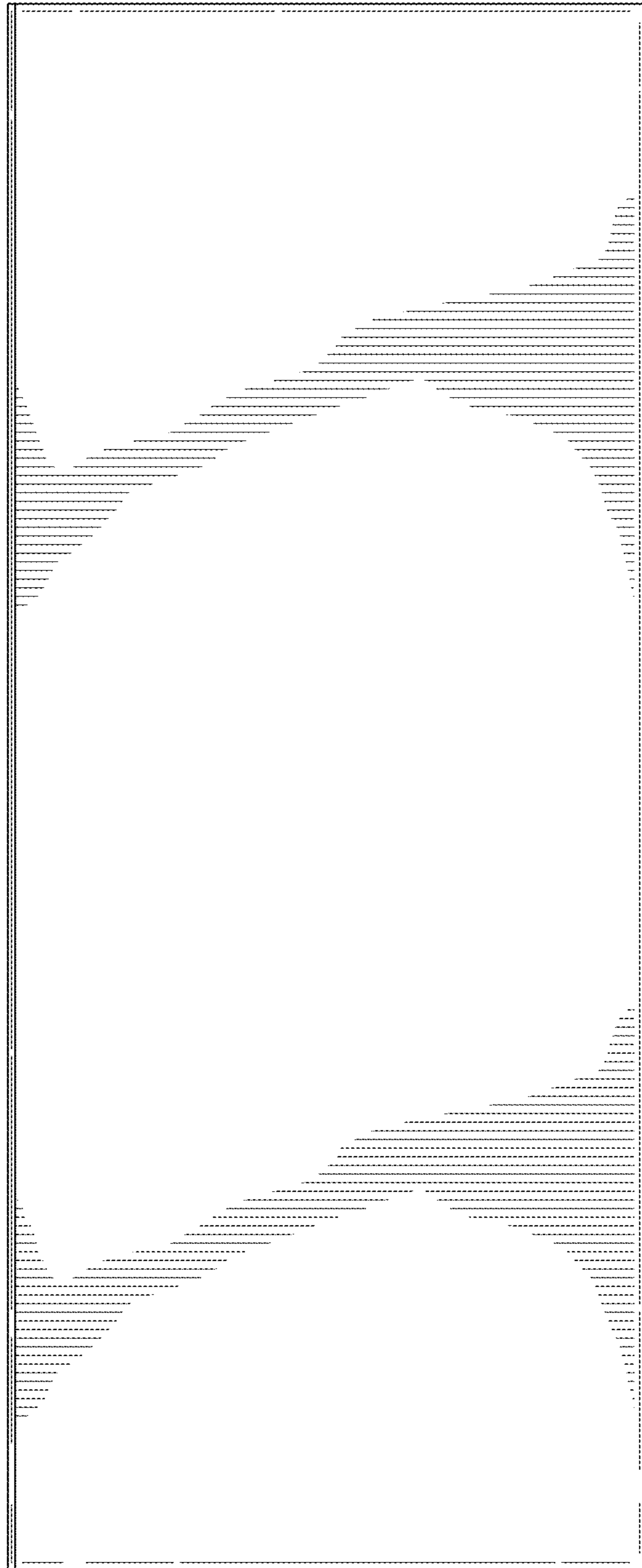

FIG. 3

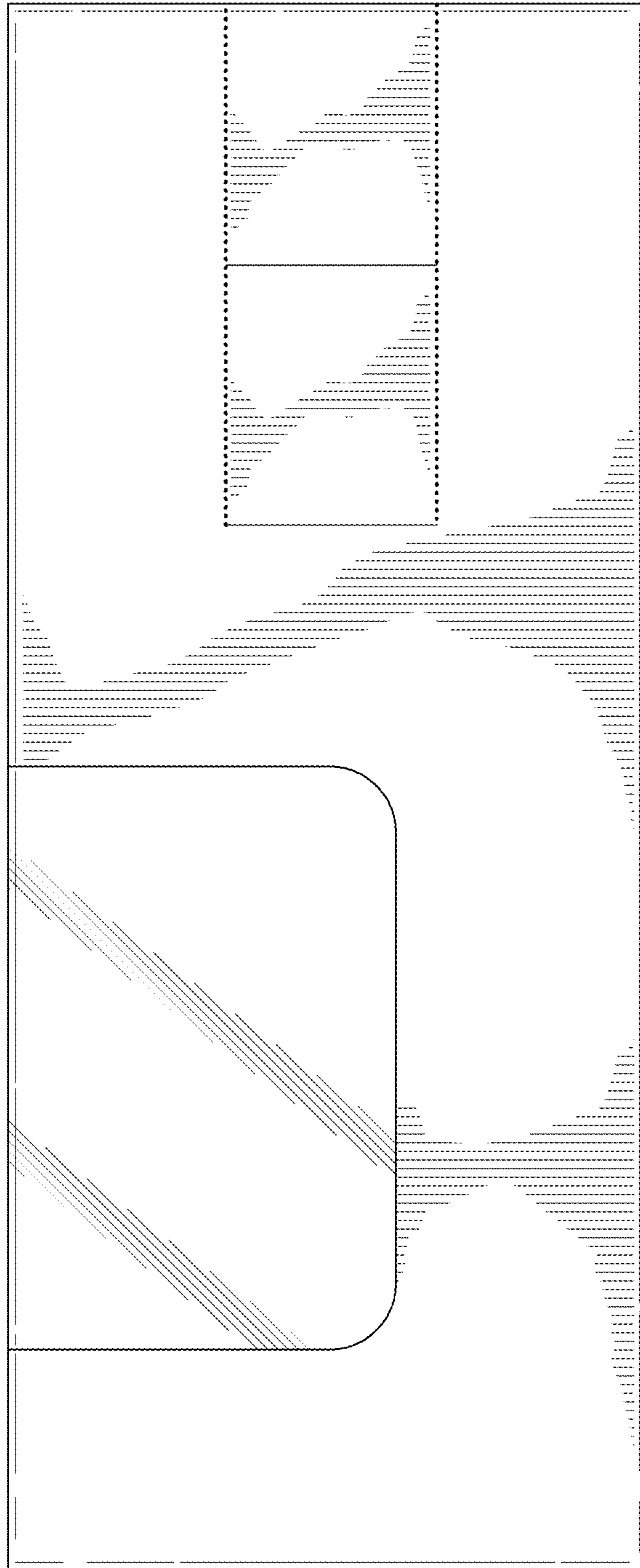

FIG. 4

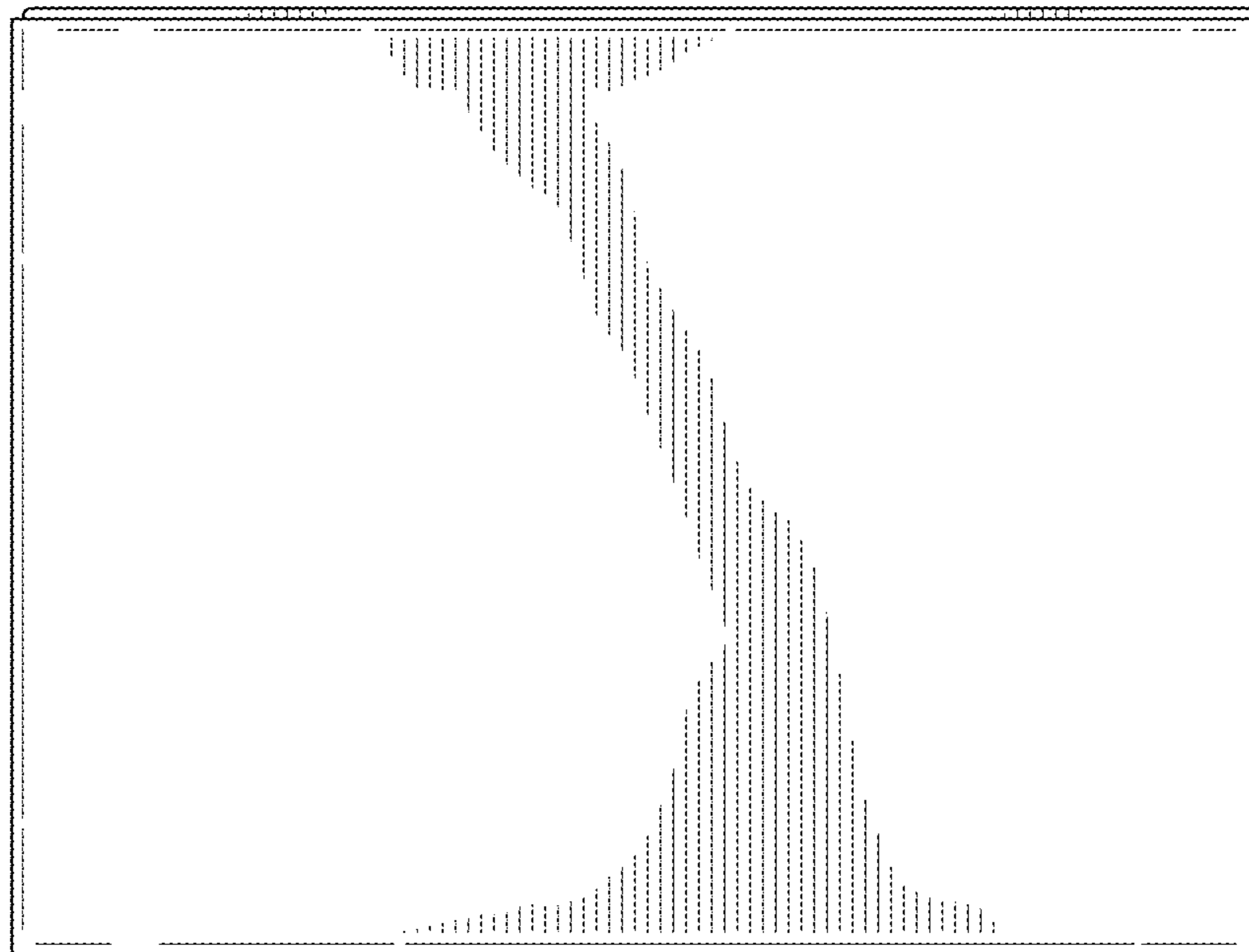

FIG. 5

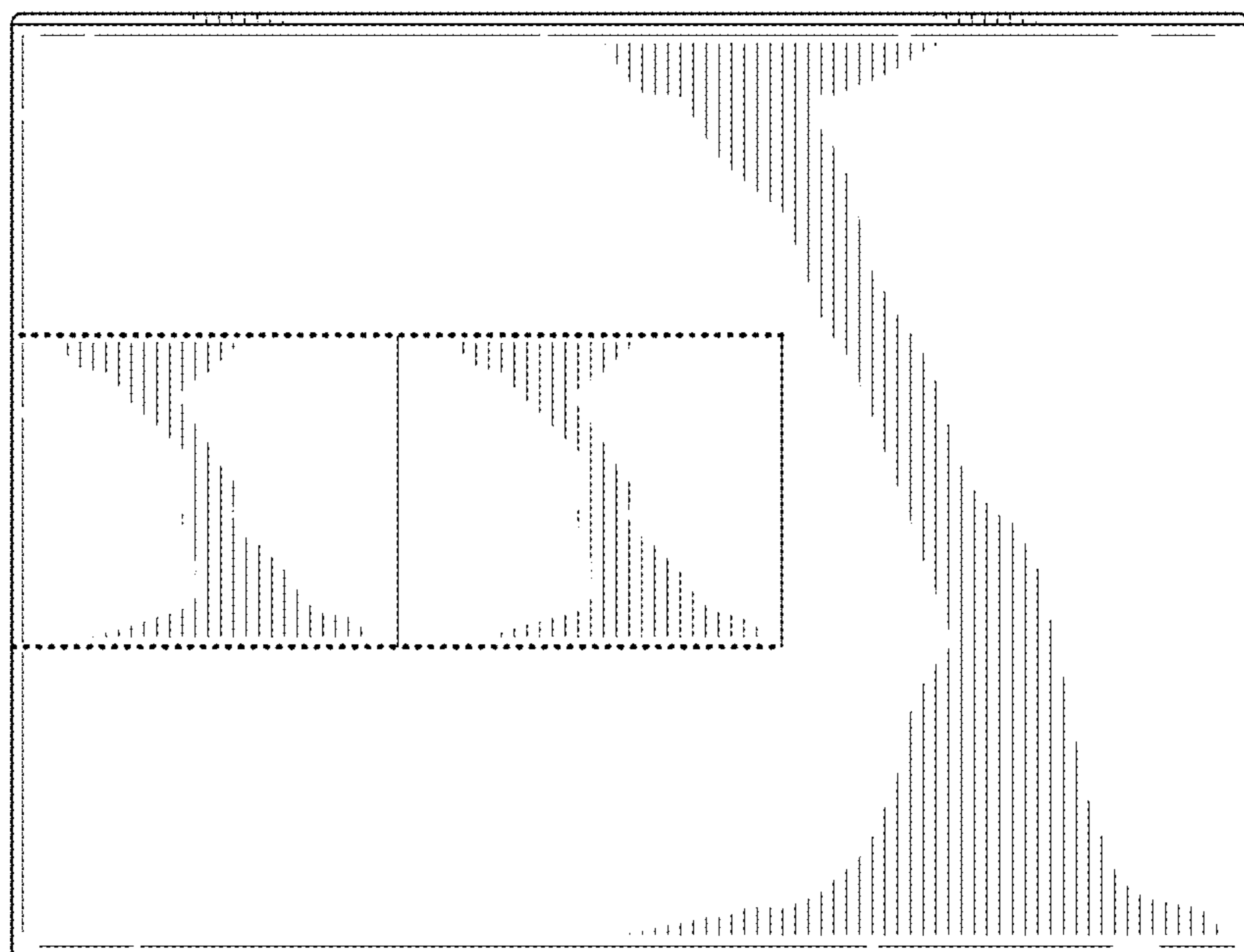

FIG. 6

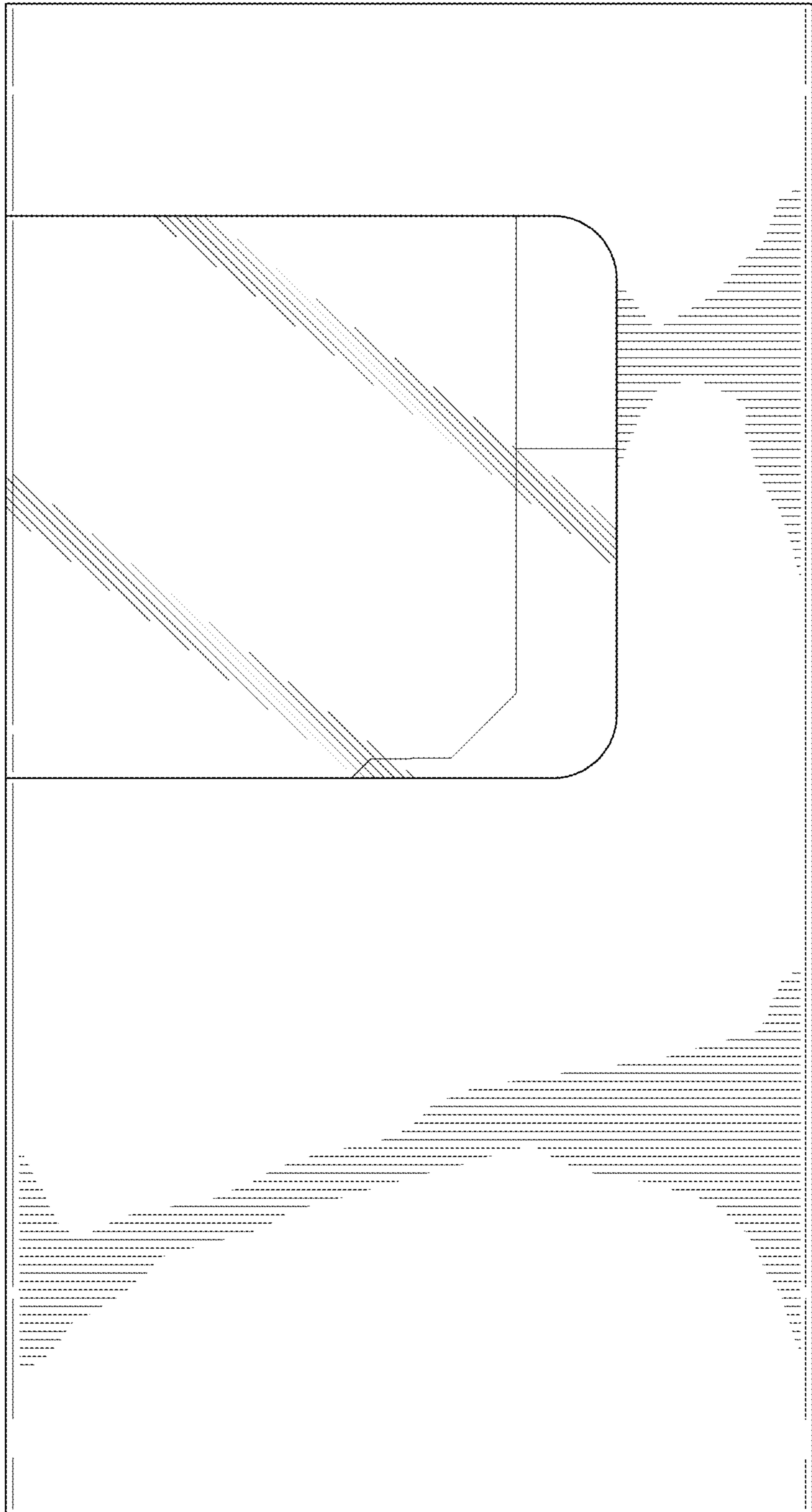

FIG. 7

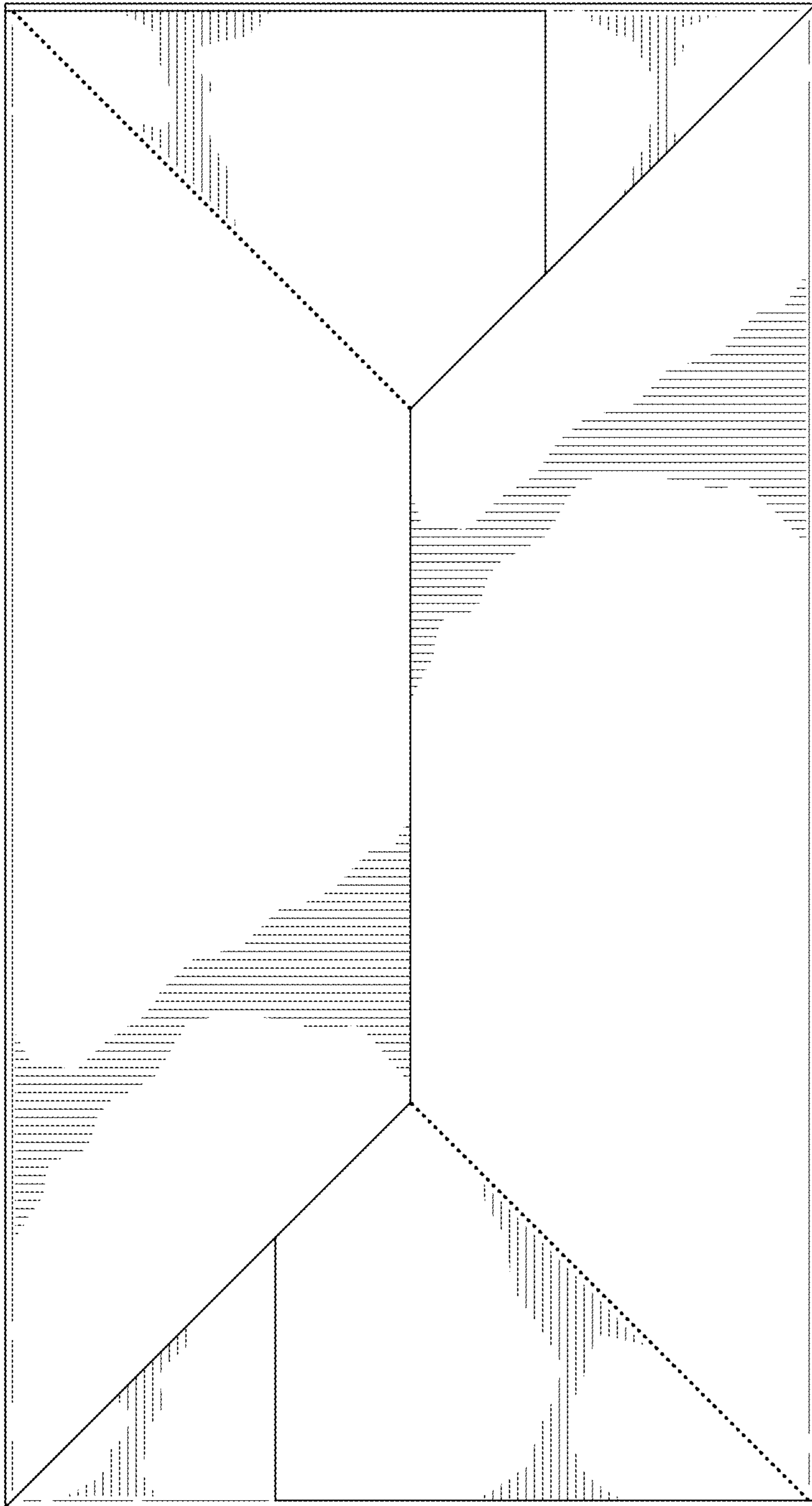

FIG. 8

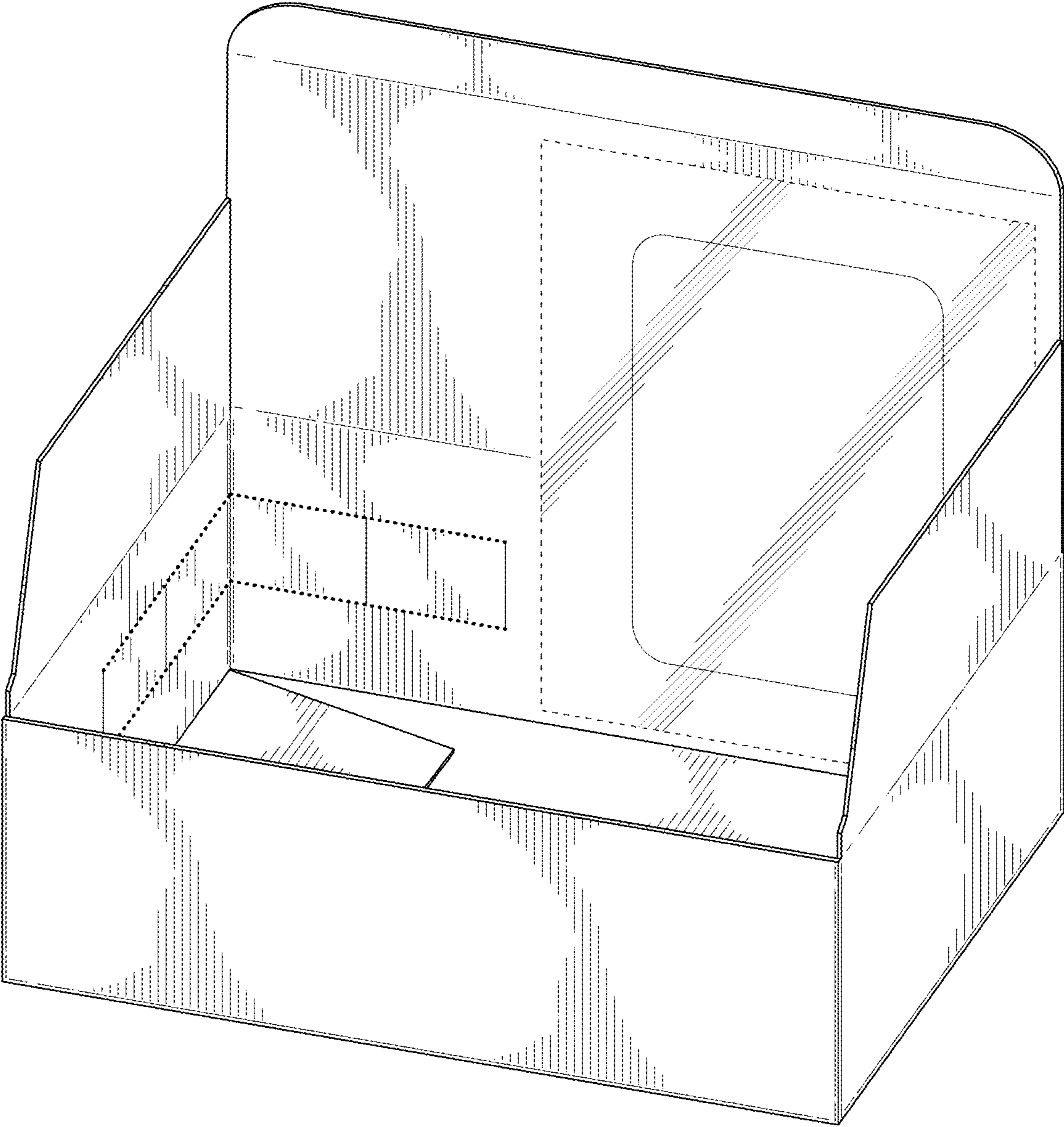

FIG. 9

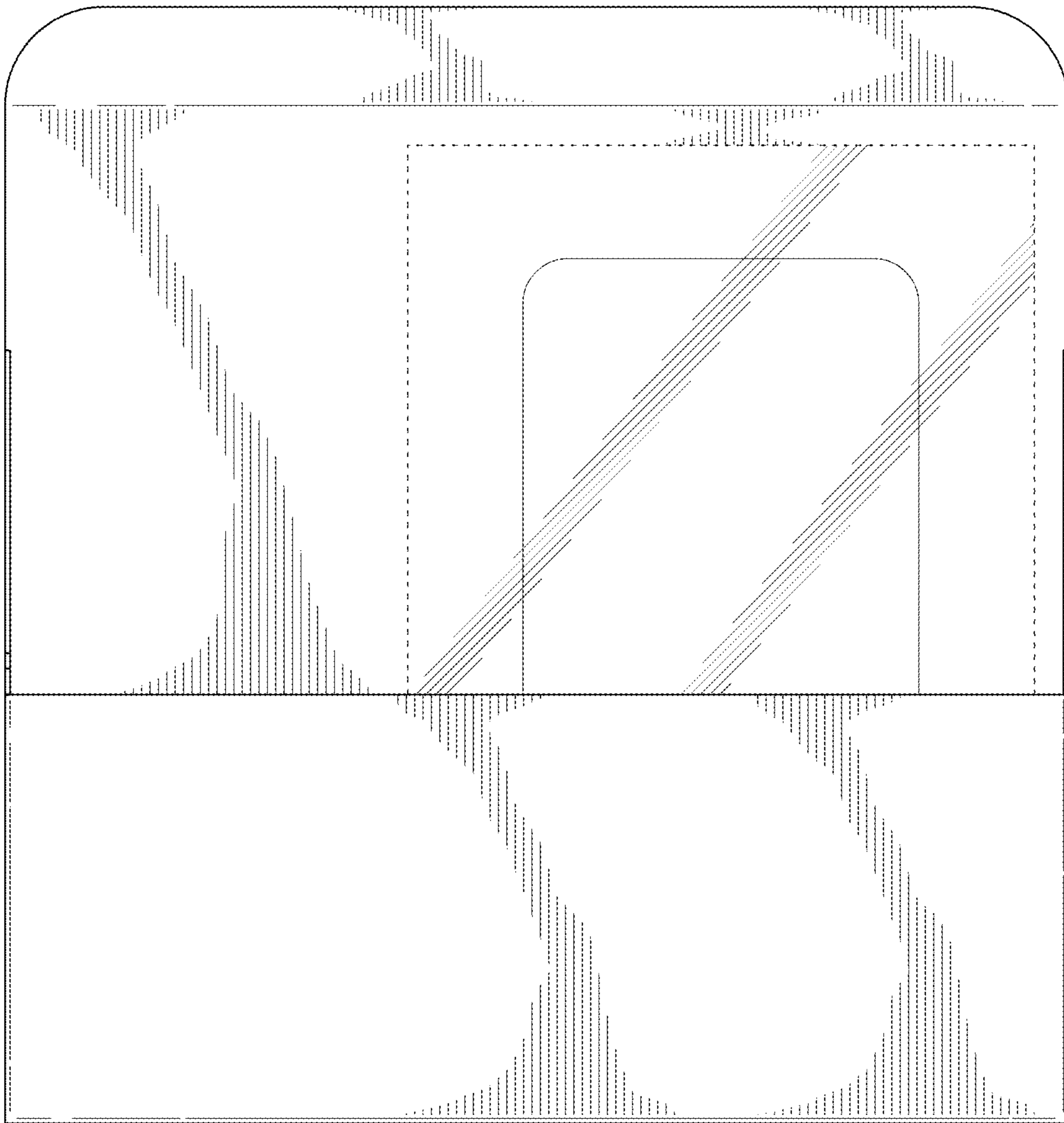

FIG. 10

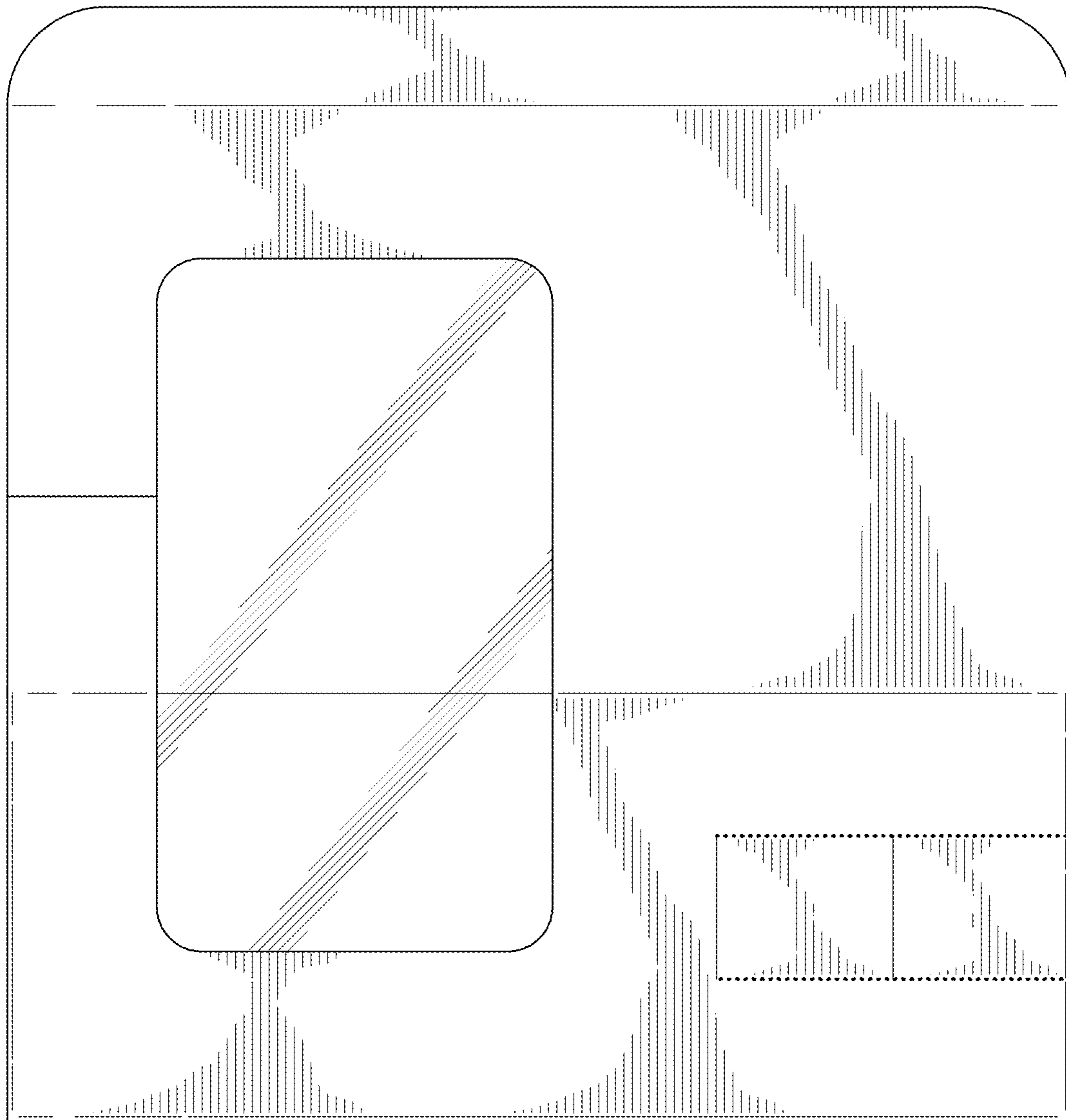

FIG. 11

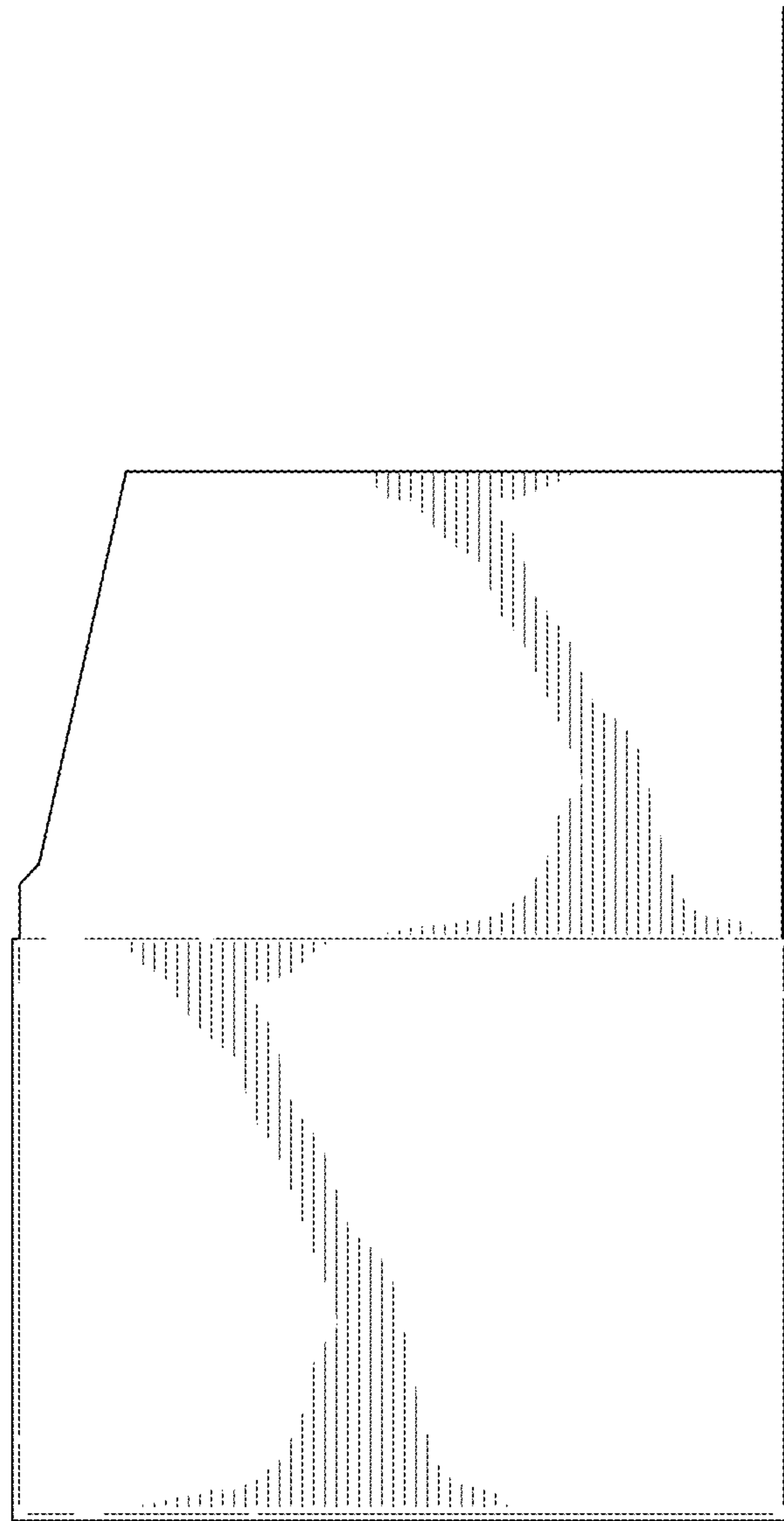

FIG. 12

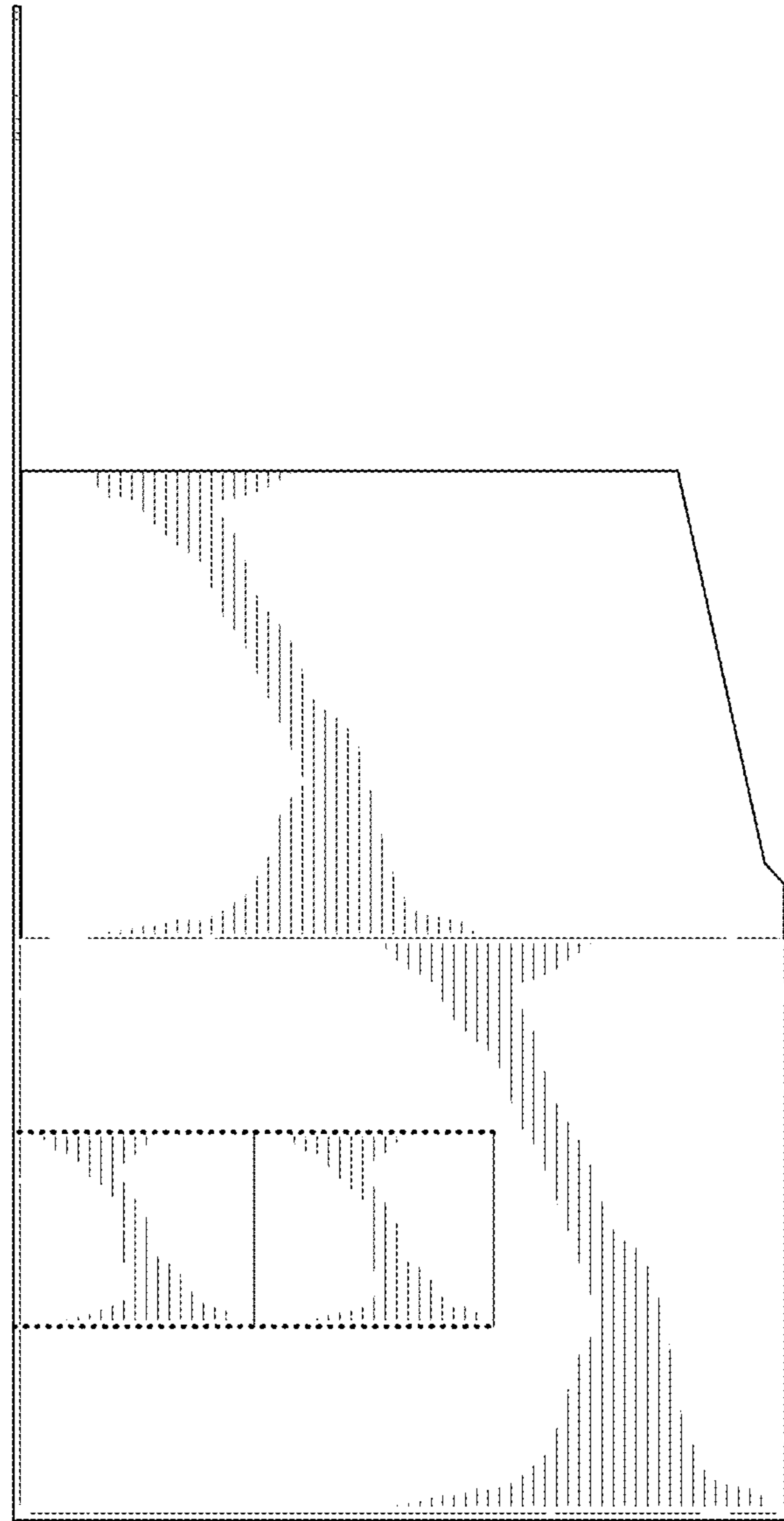

FIG. 13

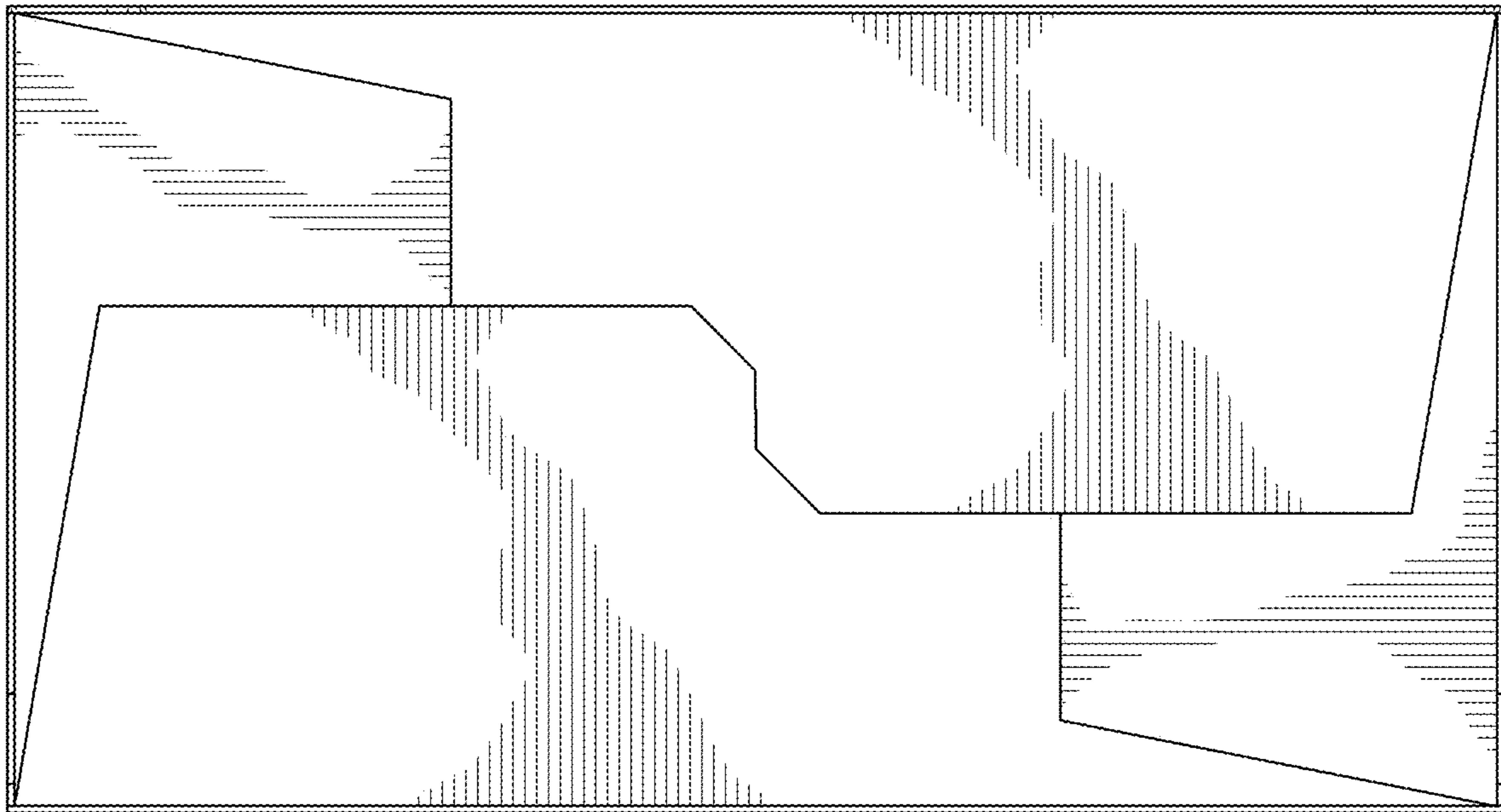

FIG. 14

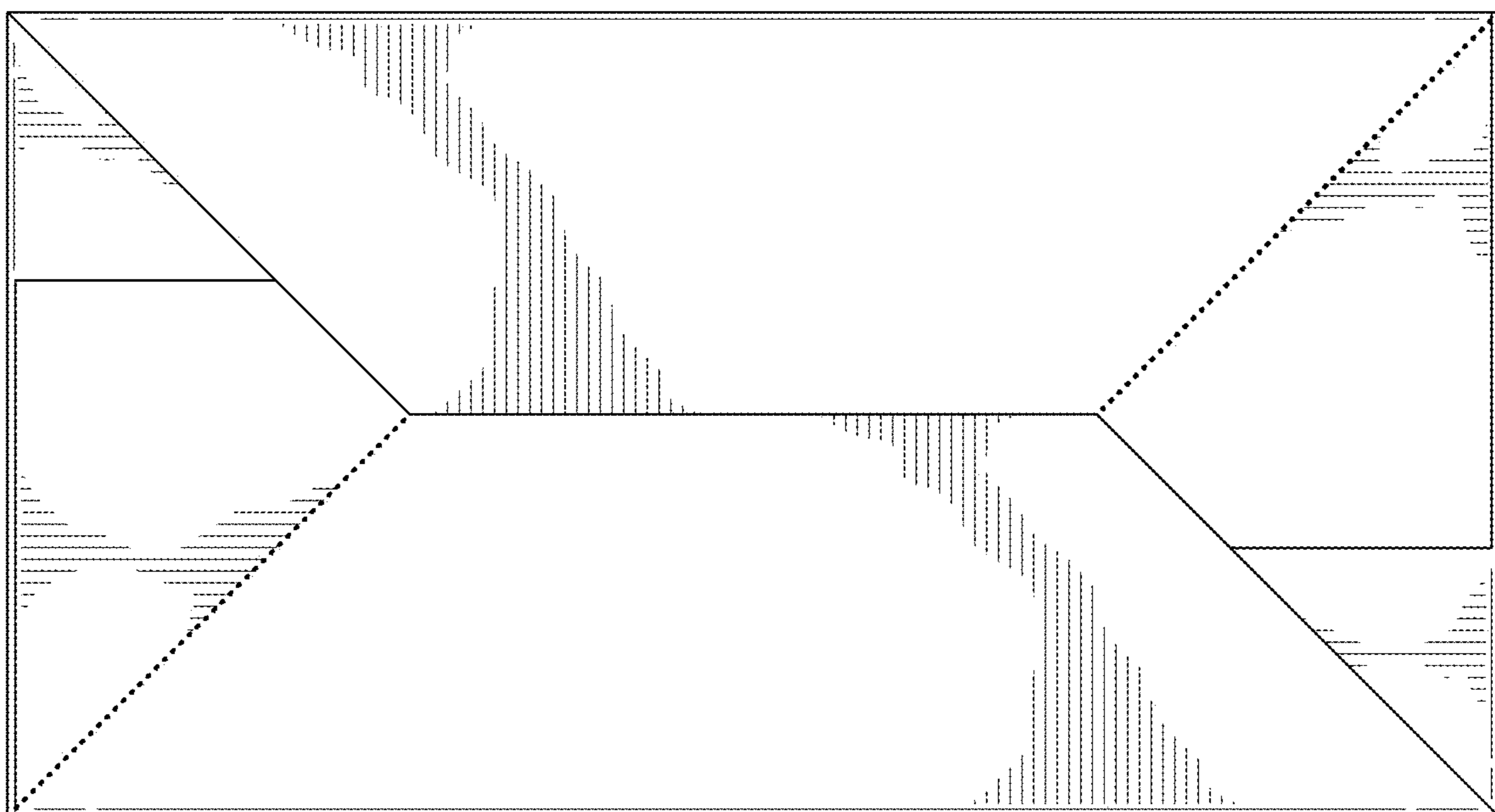

FIG. 15

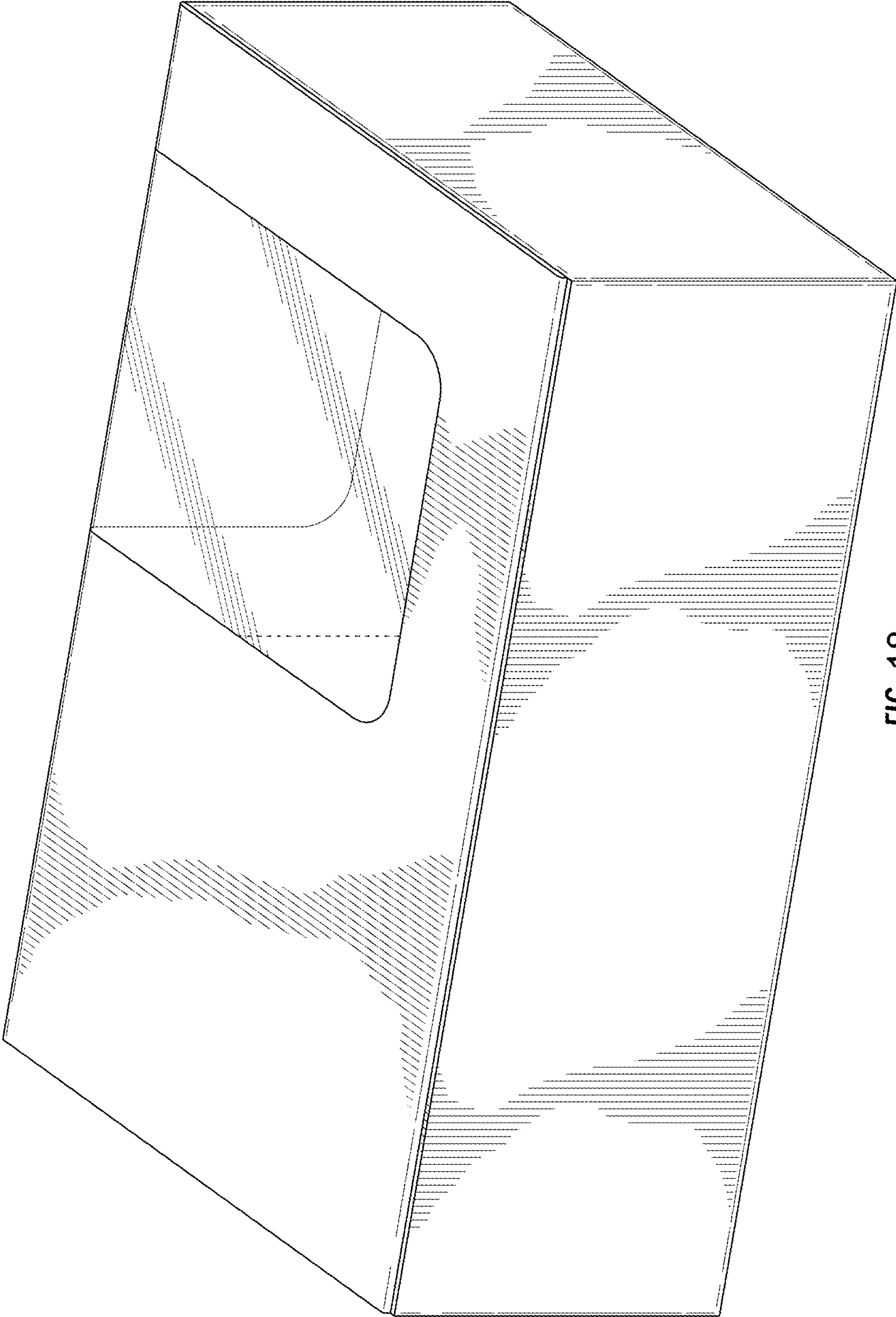

FIG. 18

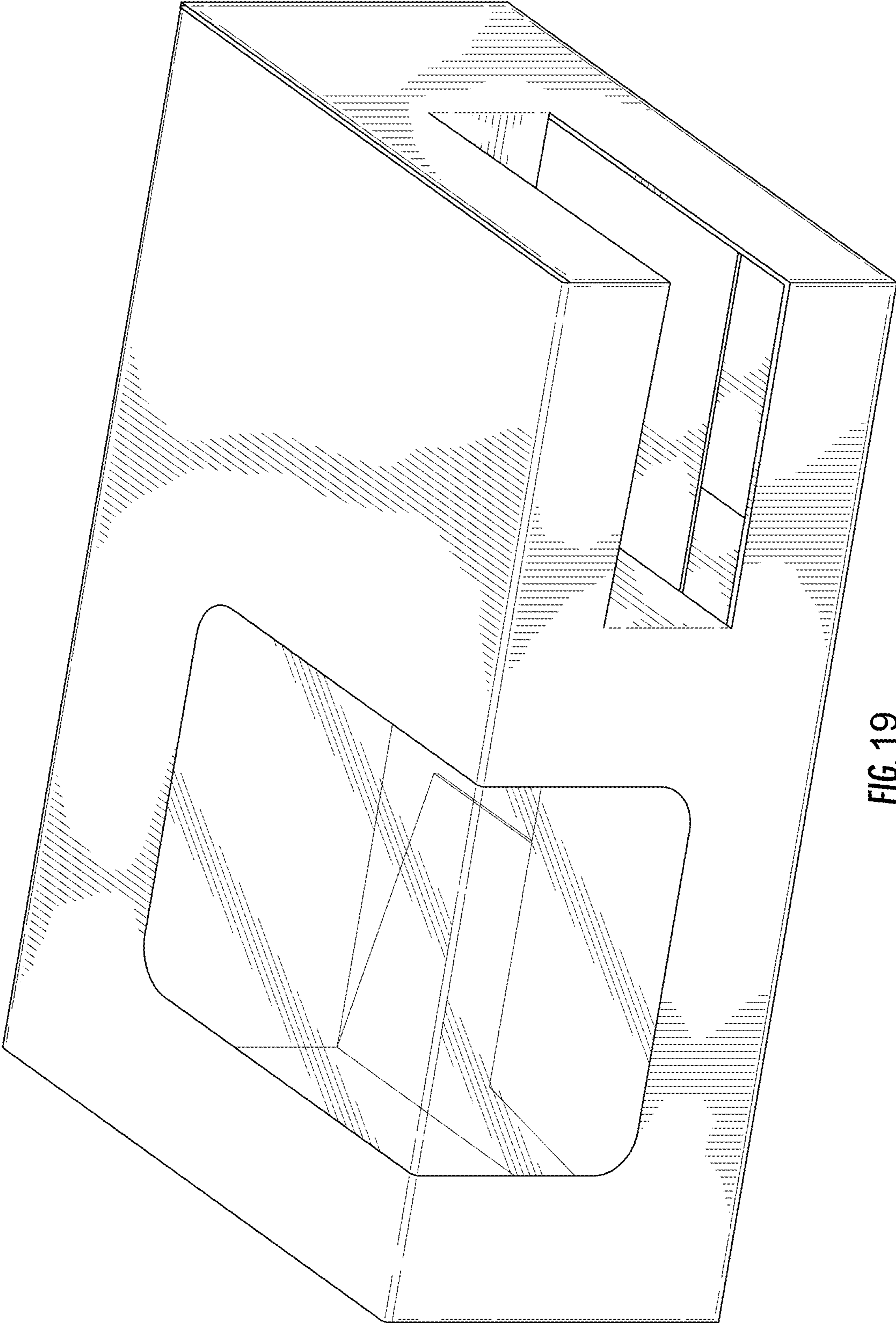

FIG. 19

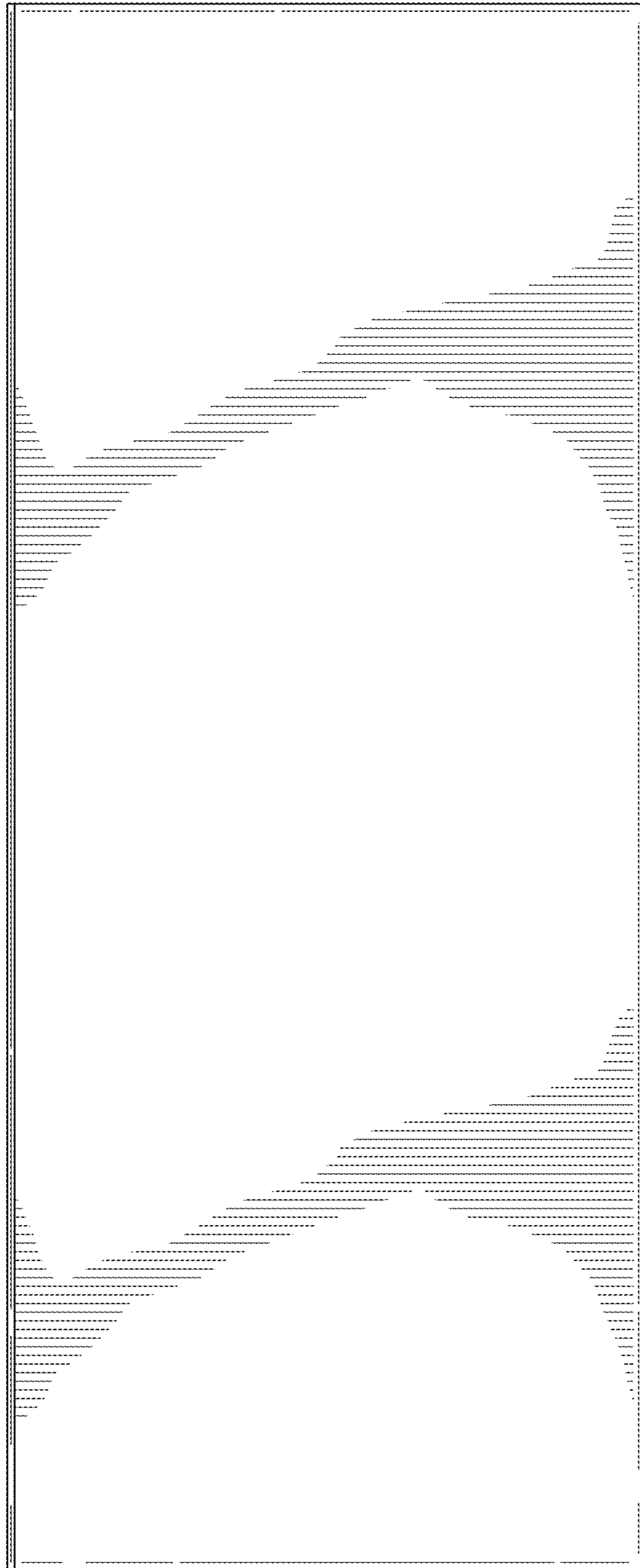

FIG. 20

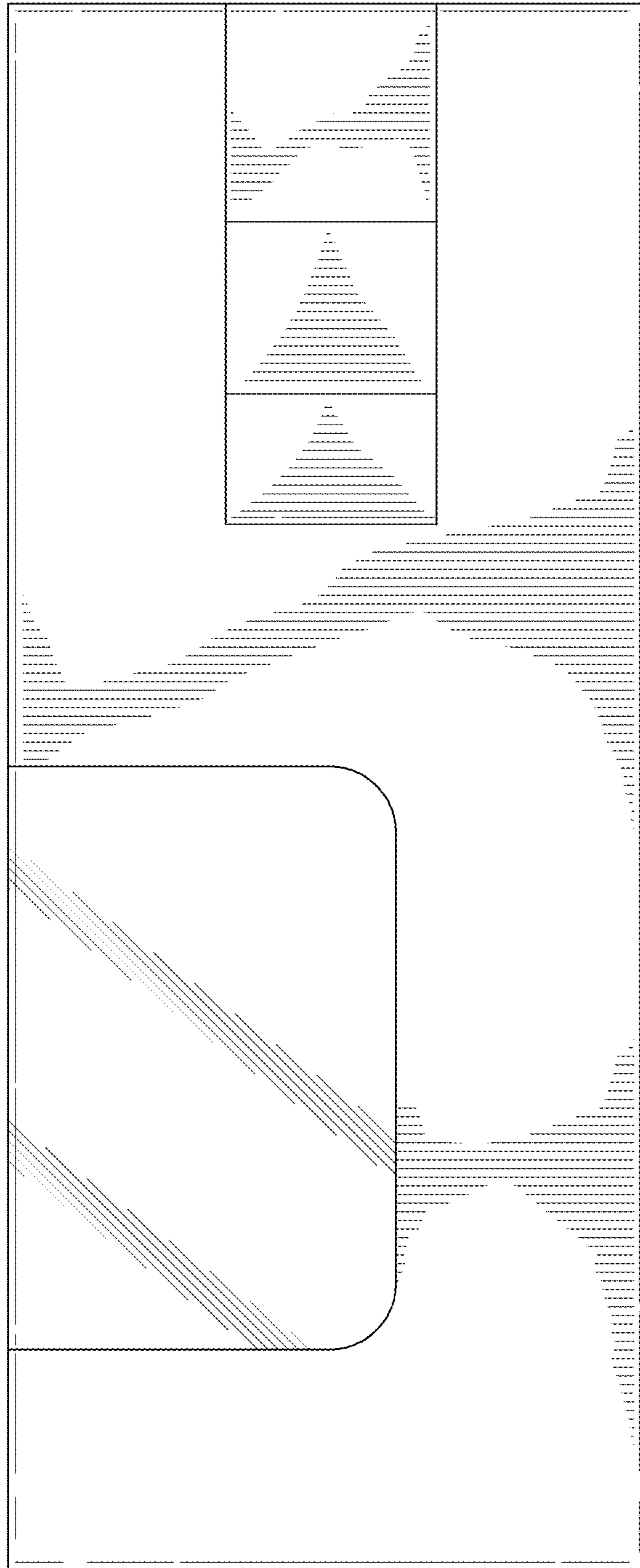

FIG. 21

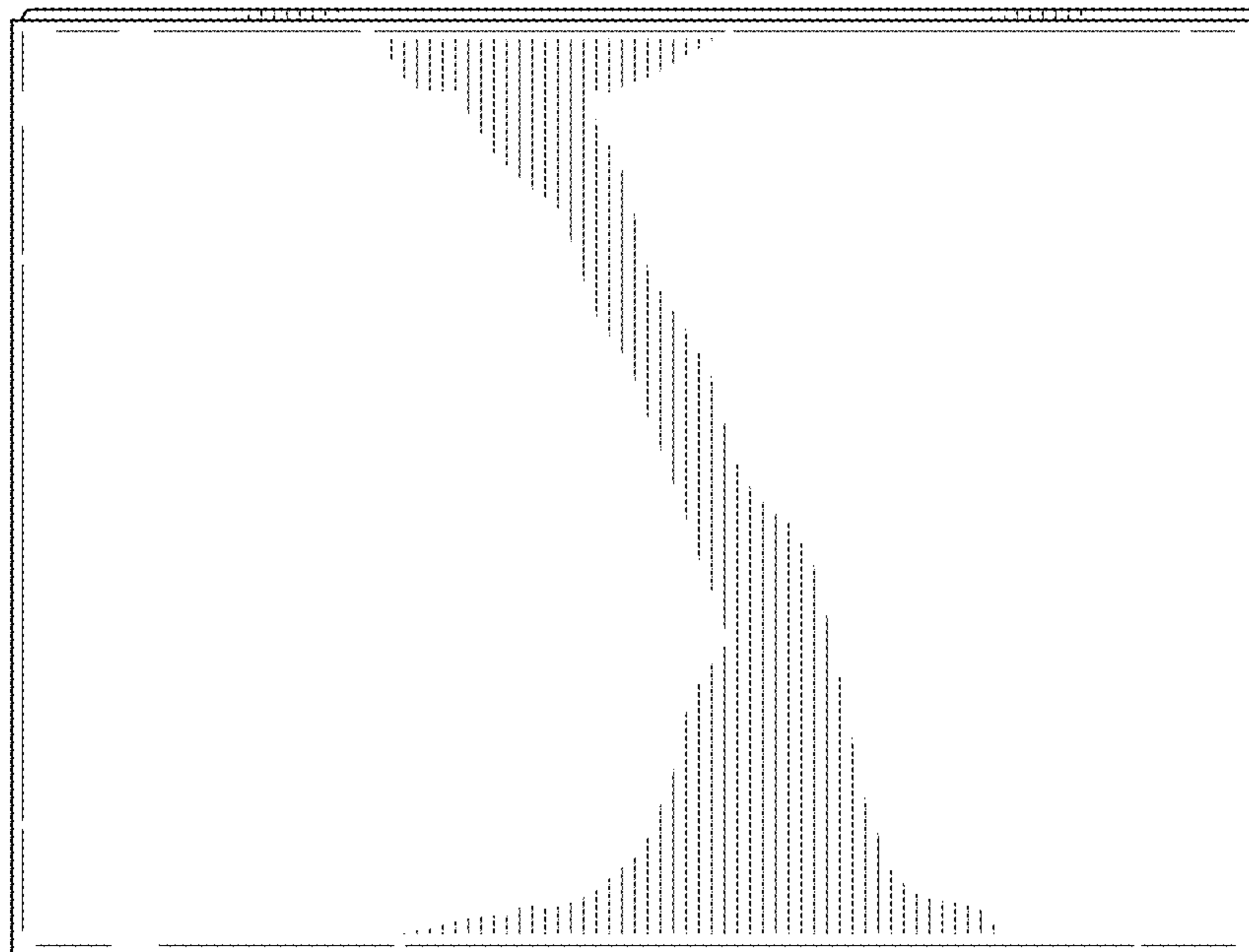

FIG. 22

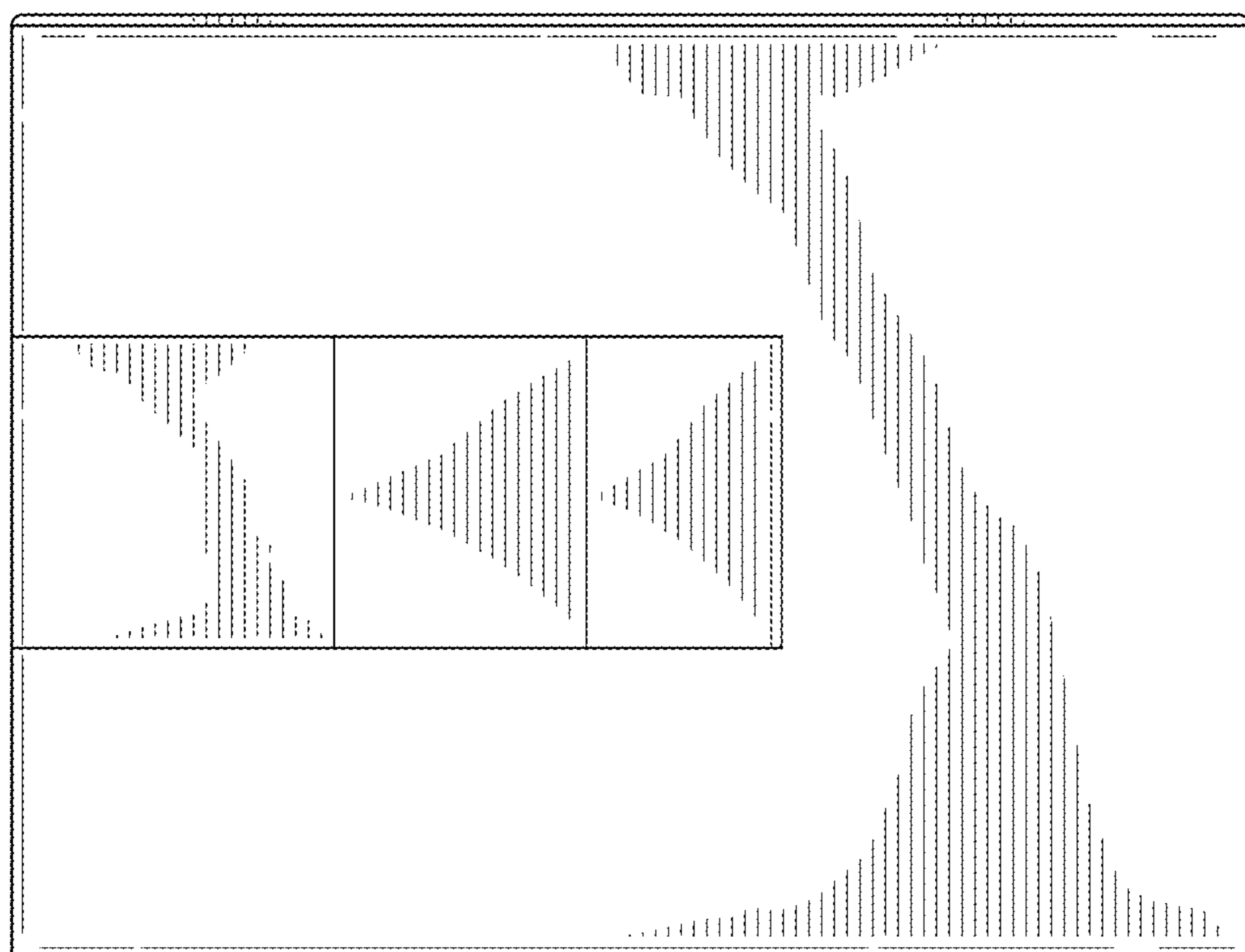

FIG. 23

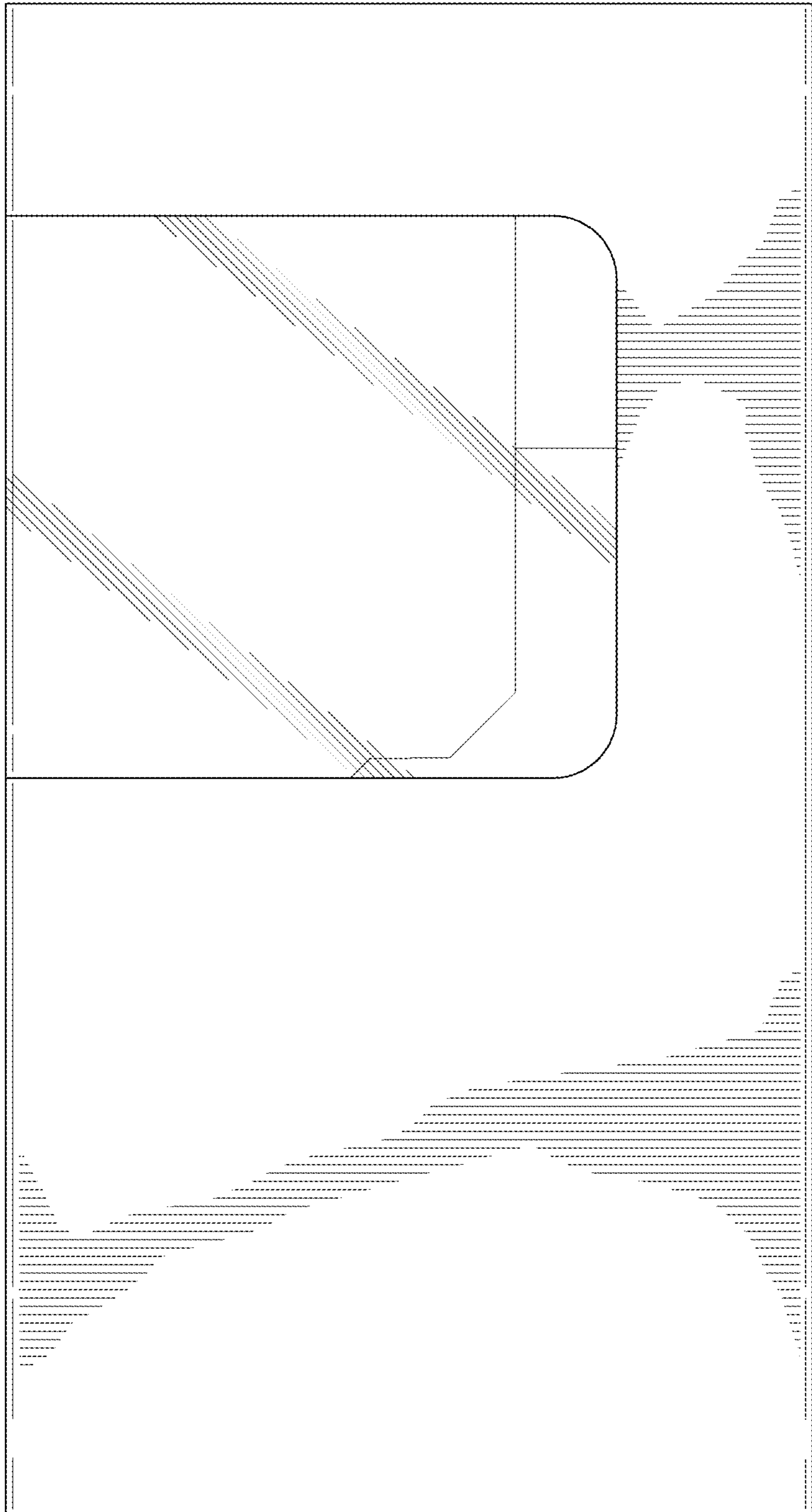

FIG. 24

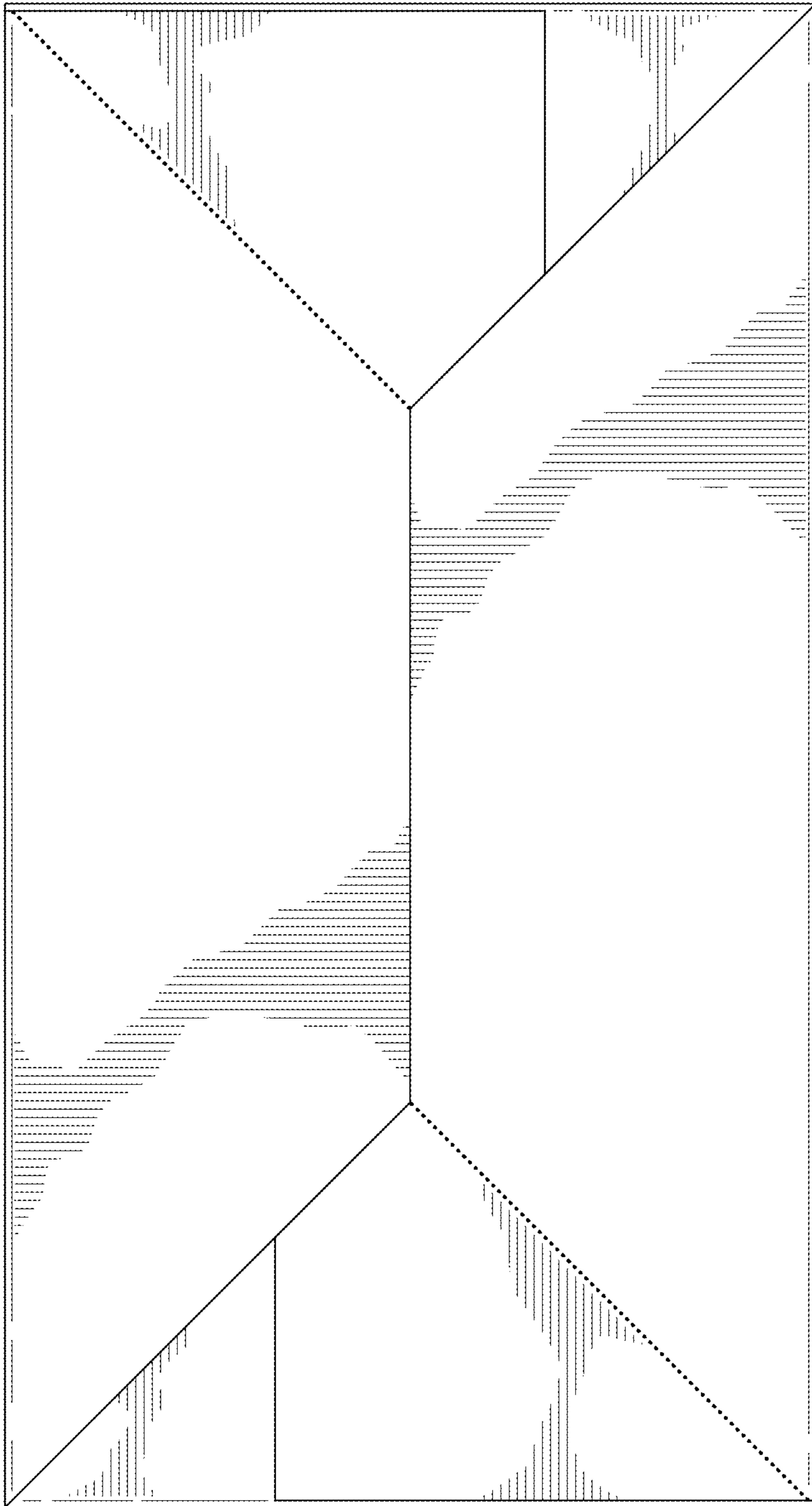

FIG. 25

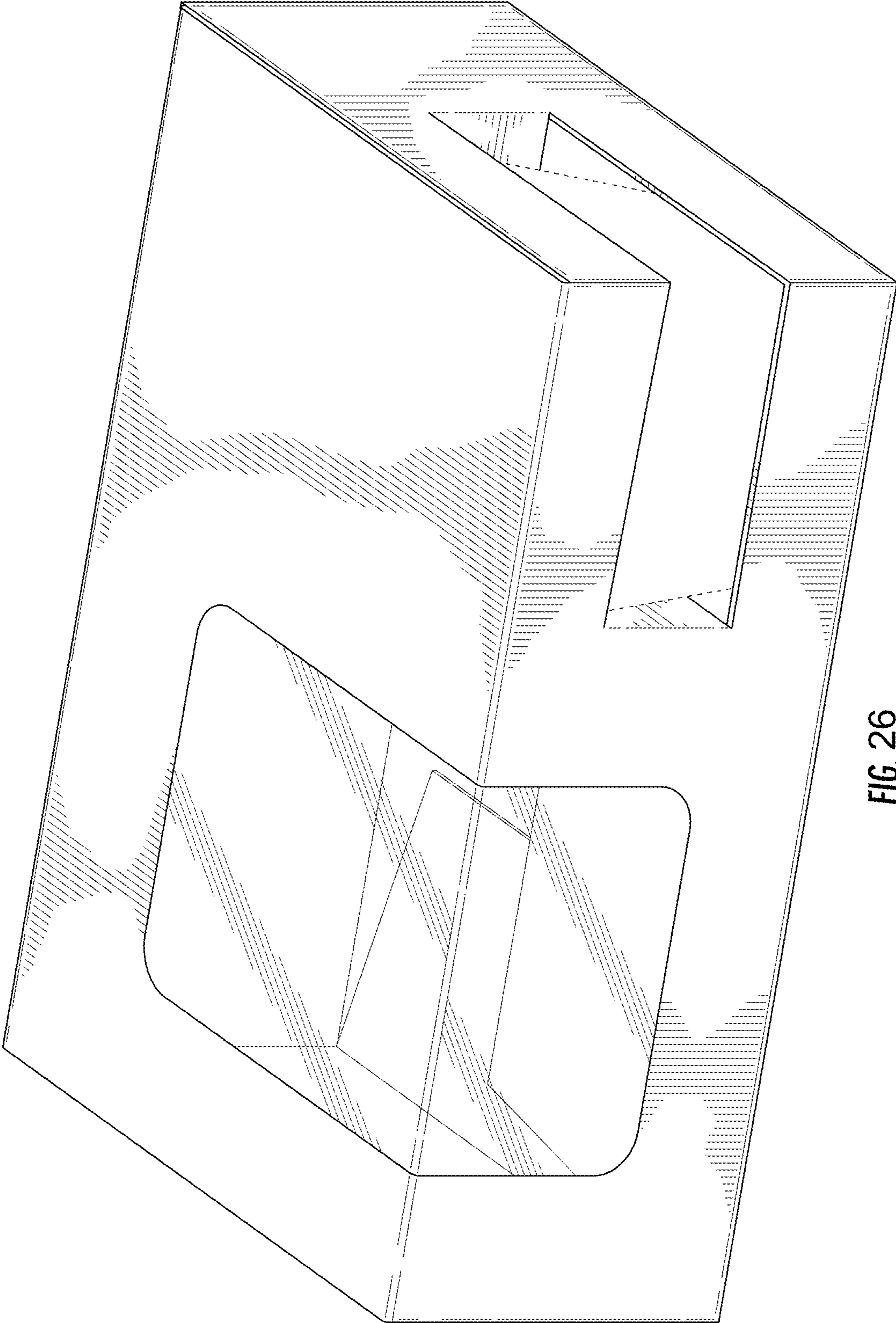

FIG. 26

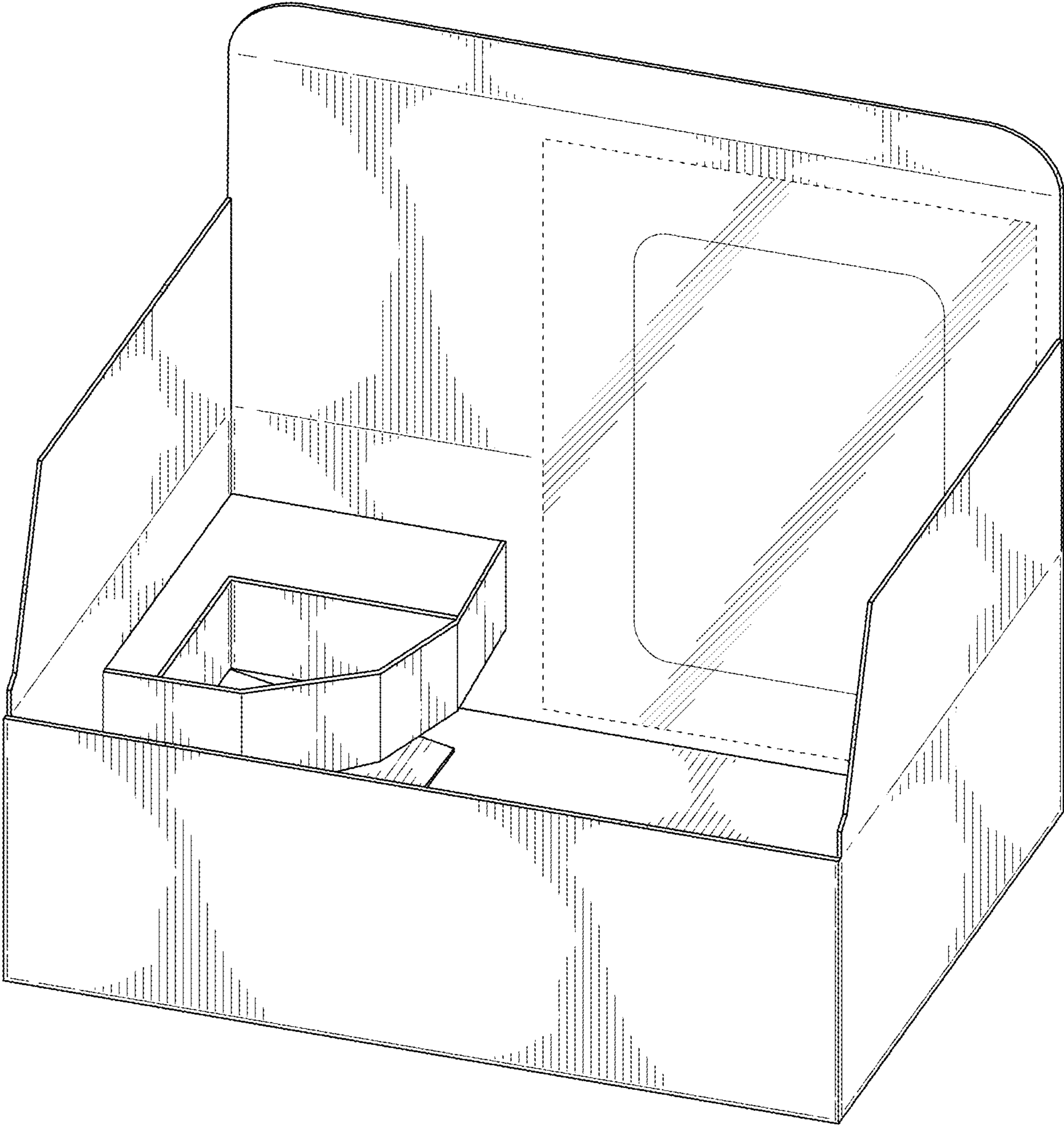

FIG. 27

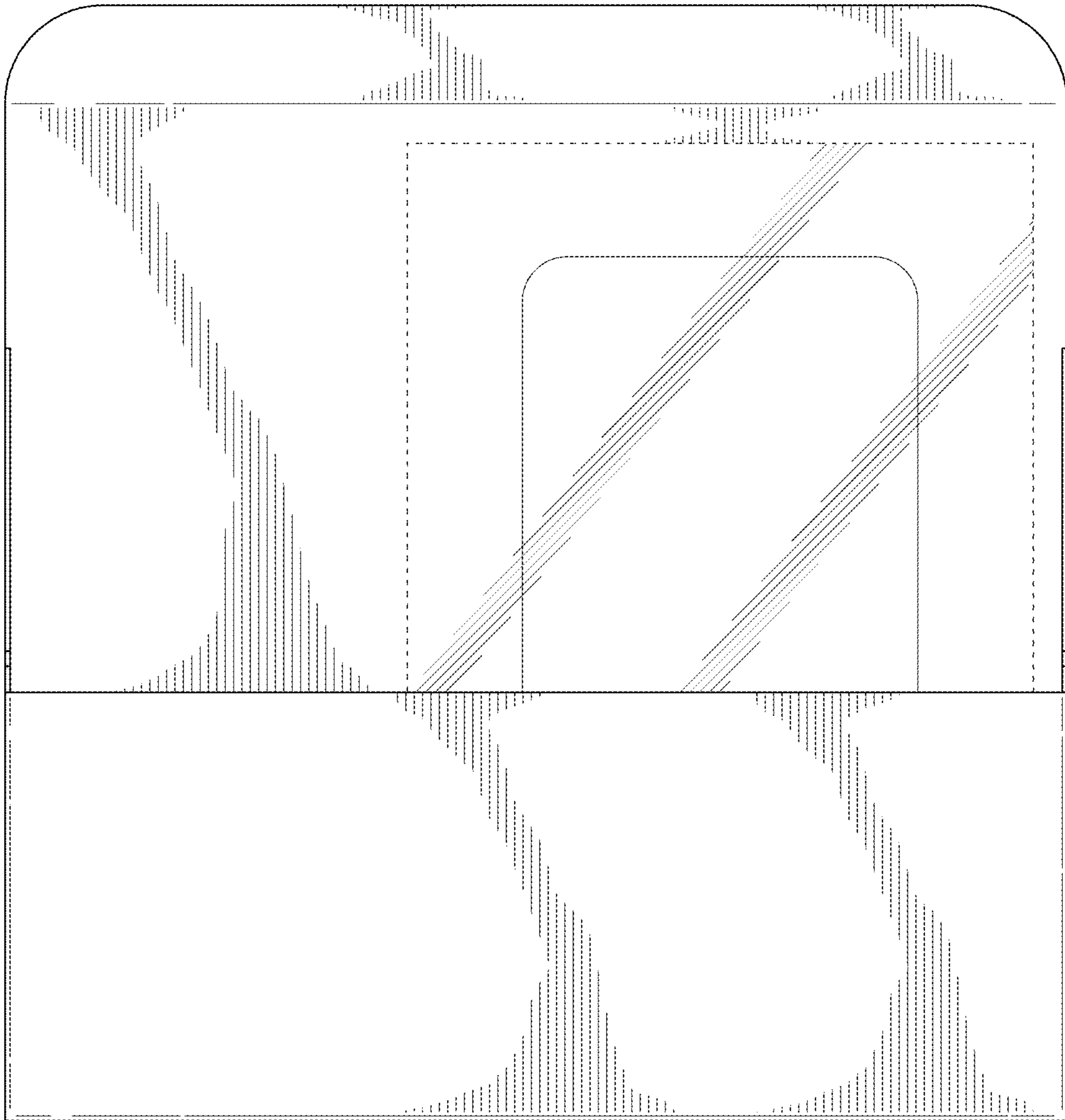

FIG. 28

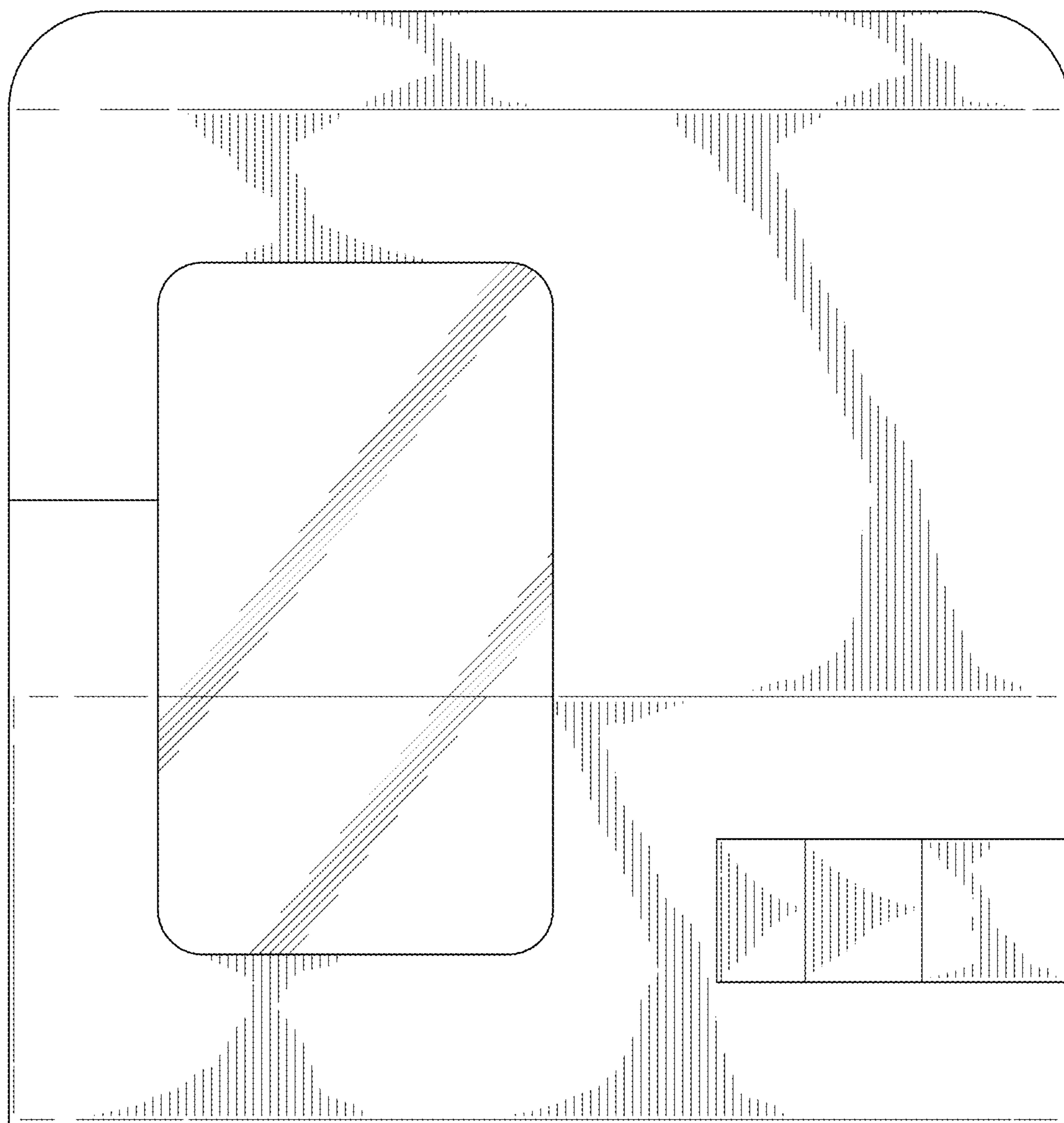

FIG. 29

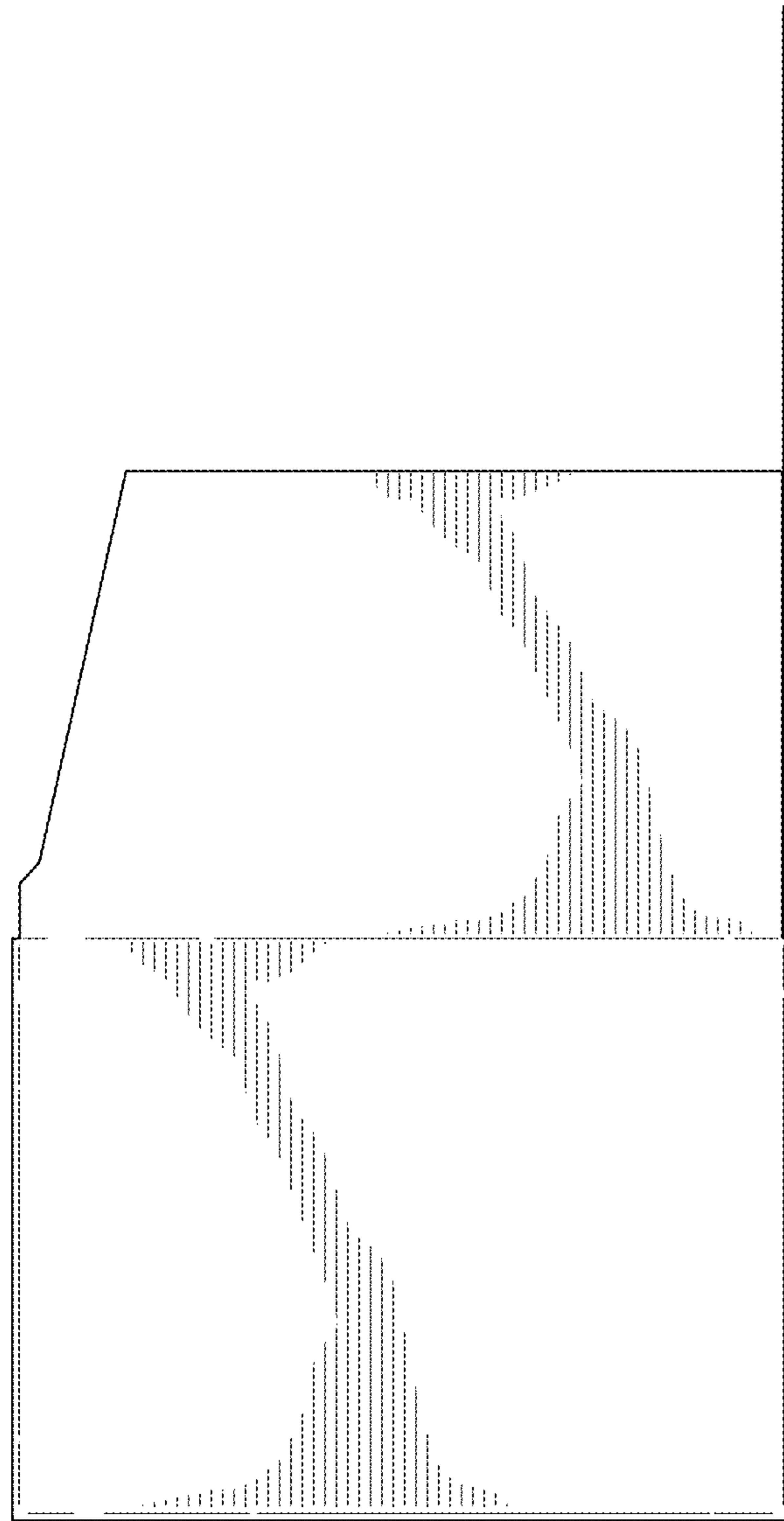

FIG. 30

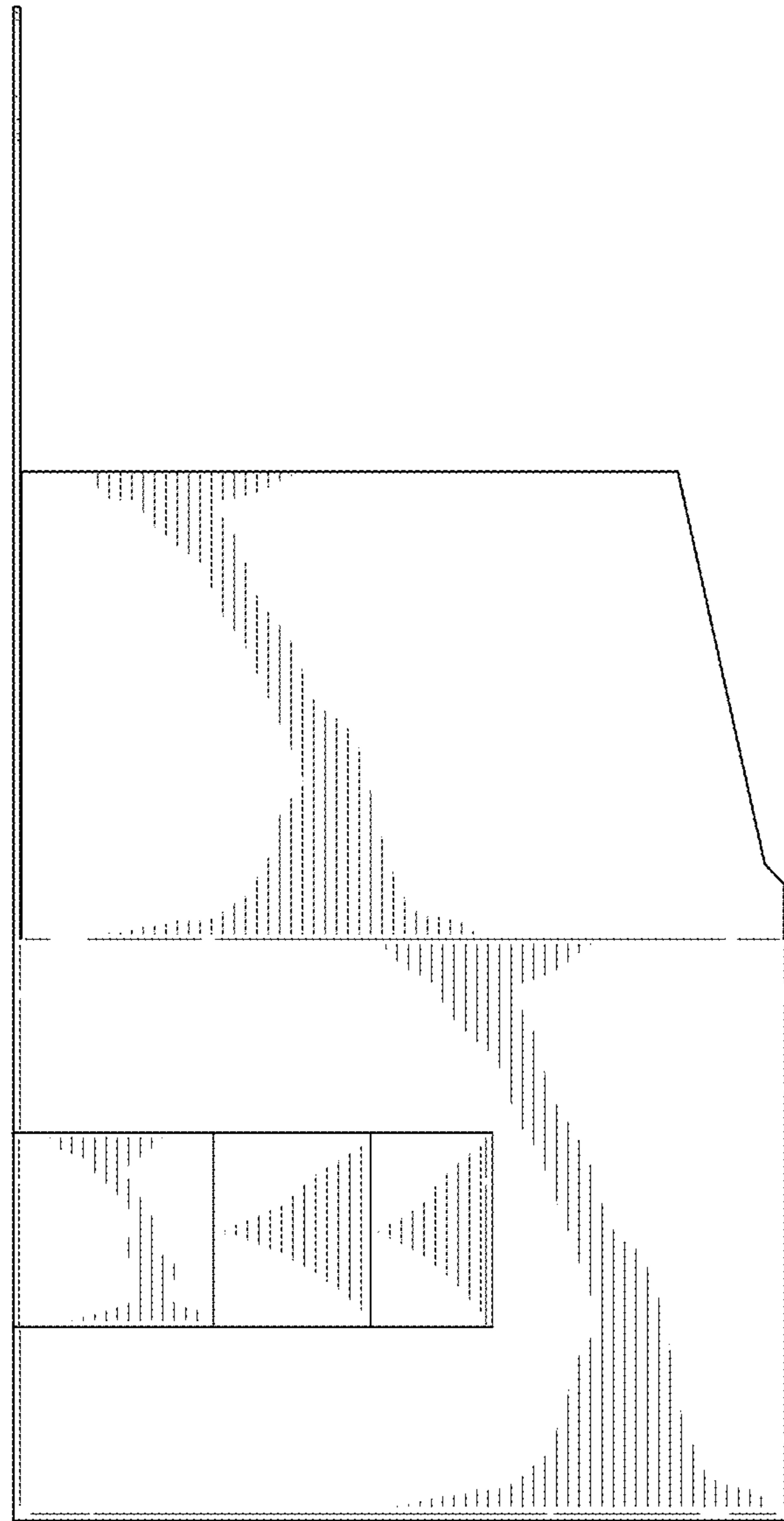

FIG. 31

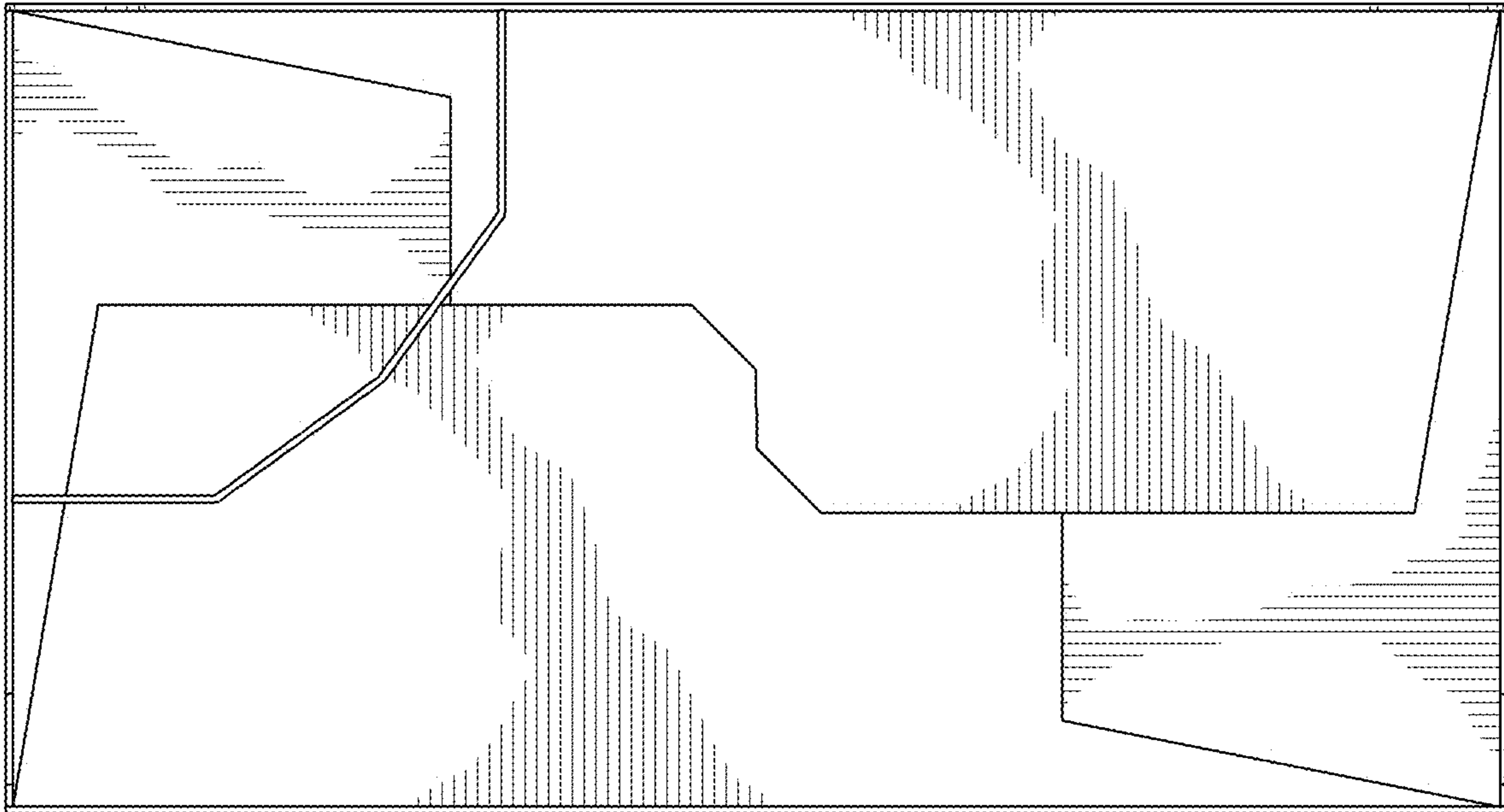

FIG. 32

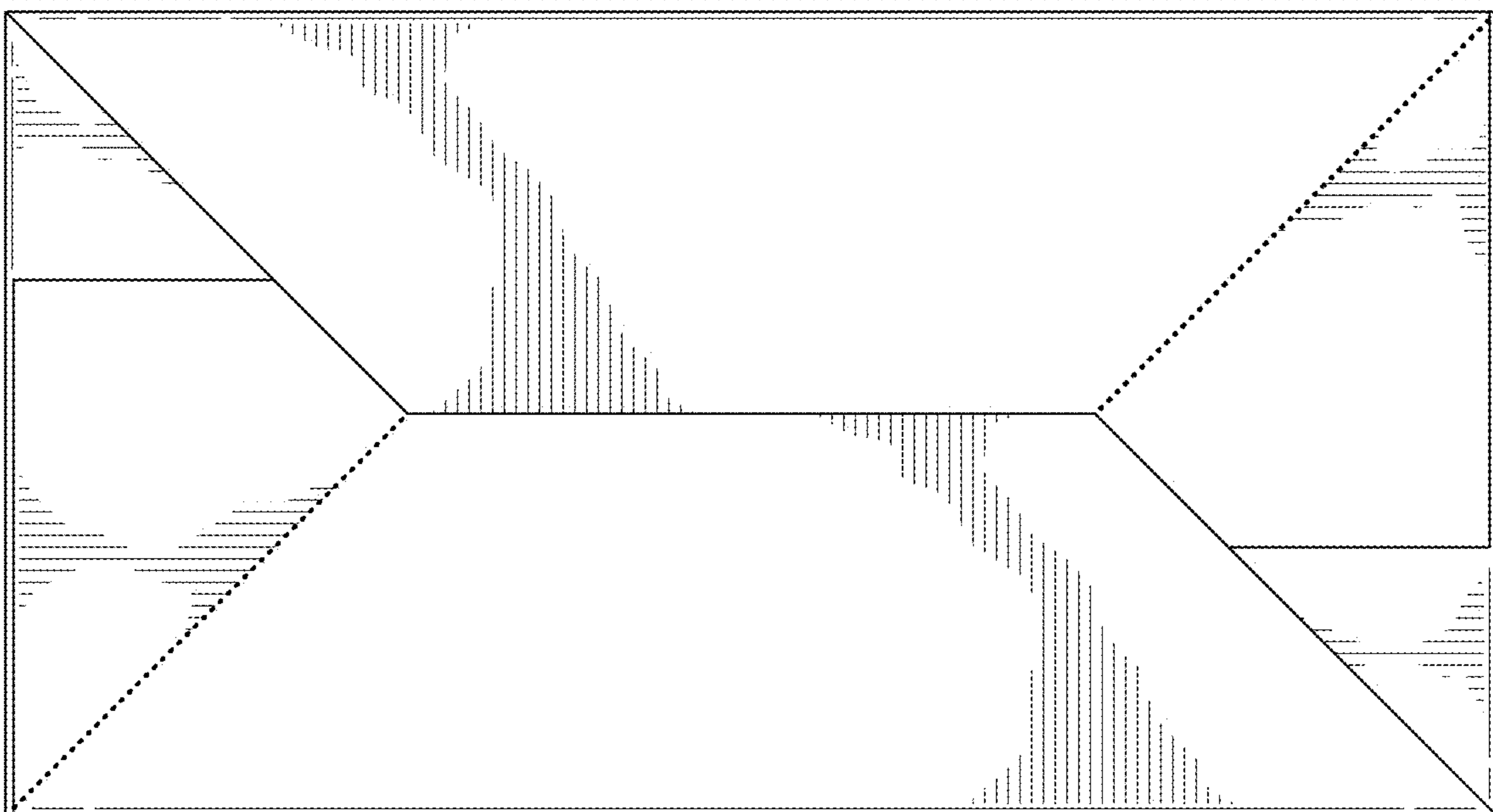

FIG. 33

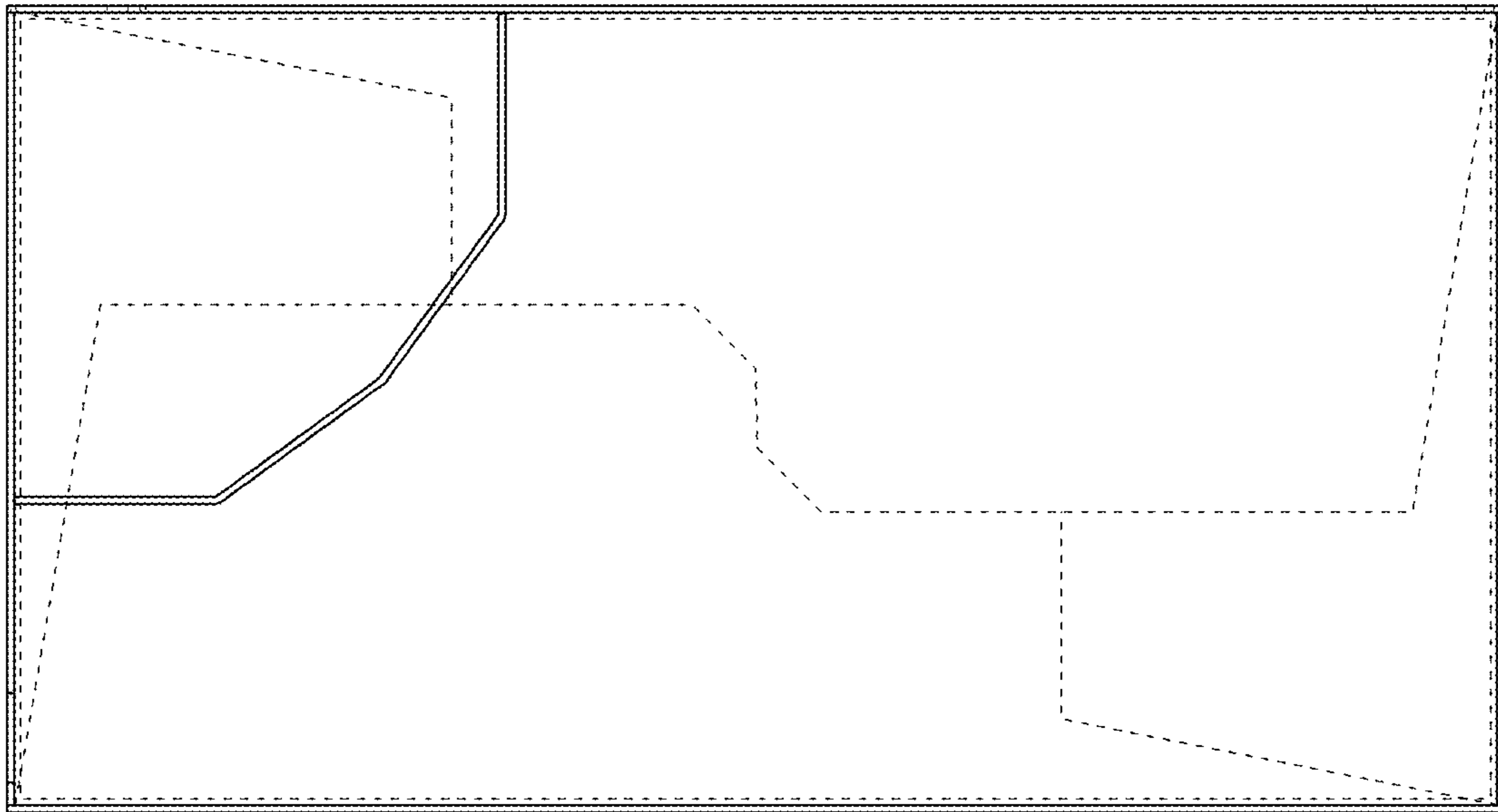

FIG. 34

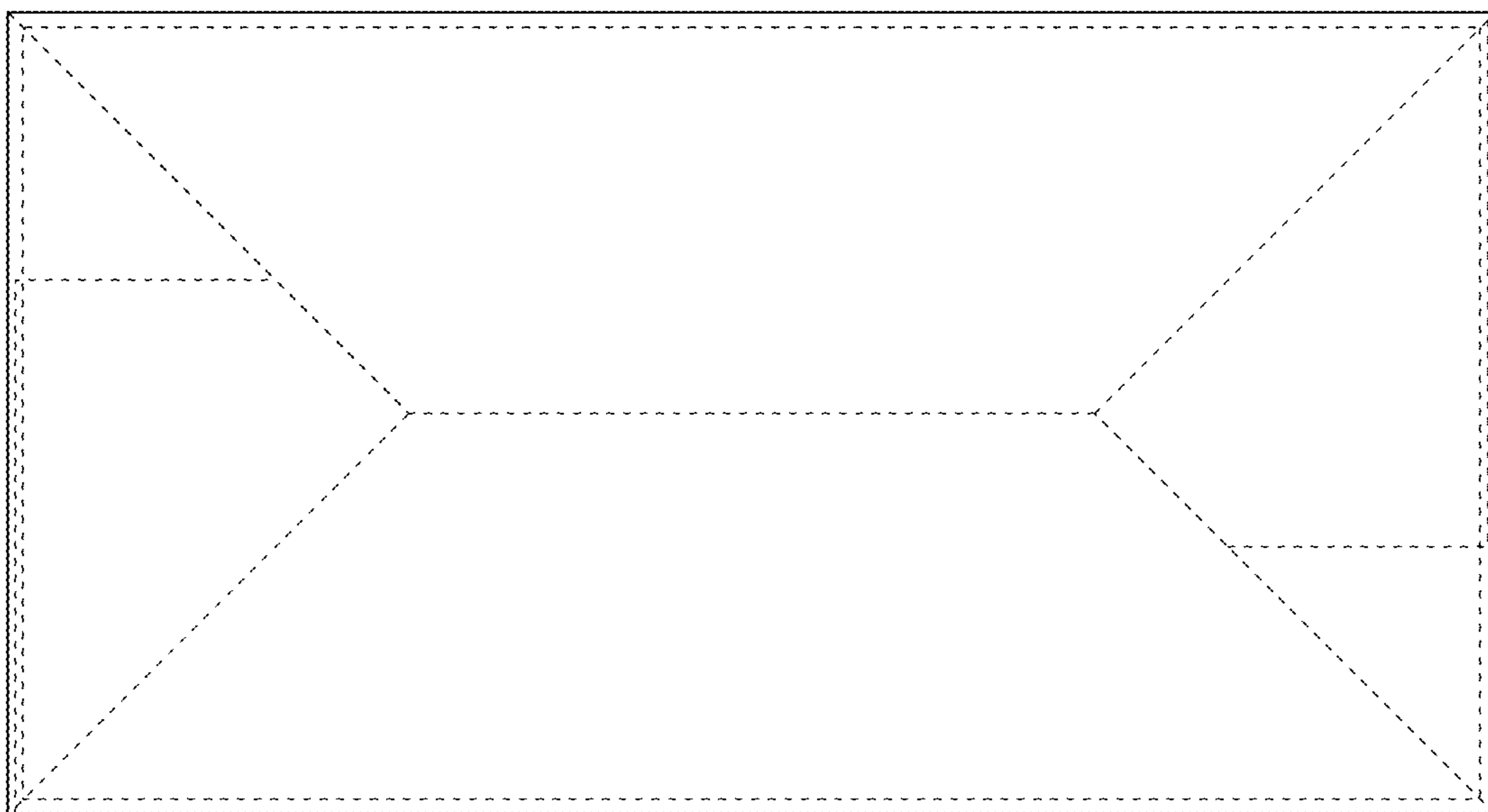

FIG. 35

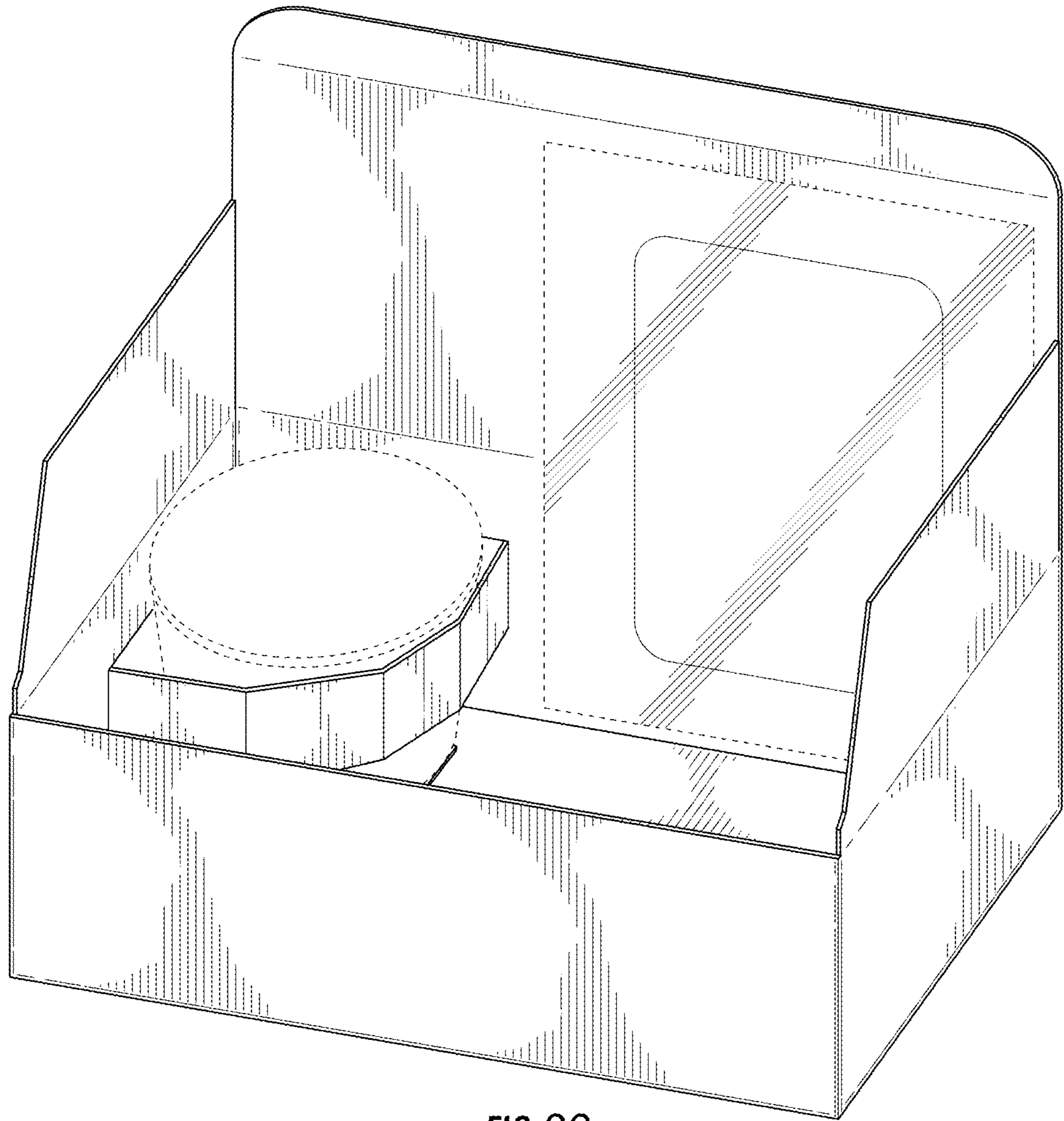

FIG. 36