



US00D952406S

(12) **United States Design Patent**
Wahl

(10) **Patent No.:** **US D952,406 S**

(45) **Date of Patent:** **** May 24, 2022**

(54) **BEVERAGE CONTAINER**

- (71) Applicant: **Pacific Market International, LLC**,
Seattle, WA (US)
- (72) Inventor: **Andrew C. F. Wahl**, Seattle, WA (US)
- (73) Assignee: **Pacific Market International, LLC**,
Seattle, WA (US)
- (**) Term: **15 Years**
- (21) Appl. No.: **29/704,950**

- (22) Filed: **Sep. 9, 2019**
- (51) **LOC (13) Cl.** **07-01**
- (52) **U.S. Cl.**
USPC **D7/511**

- (58) **Field of Classification Search**
USPC D7/300, 300.2, 301, 305, 392, 392.1,
D7/396.2, 396.3, 413, 507, 509–516, 519,
D7/520, 522–525, 528, 529, 531, 532,
D7/536, 537, 608, 619.2, 620, 623, 624.1,
D7/624.2, 624.3, 636, 900; D9/436, 447,
D9/455, 500–505, 533, 539, 549, 566,
D9/575; D23/262, 263; D24/197, 224
CPC A47G 19/22; A47G 19/2205; A47G
19/2211; A47G 19/2222; A47G 19/2227;
A47G 19/2261; A47G 19/2266; A47G
19/2272; A47G 19/2288; A47G 21/18;
(Continued)

(56) **References Cited**

U.S. PATENT DOCUMENTS

- 166,350 A 8/1875 Dodge
 - 2,474,913 A 7/1949 Propst
- (Continued)

FOREIGN PATENT DOCUMENTS

- CN 302228821 12/2012
 - CN 304193691 7/2017
- (Continued)

OTHER PUBLICATIONS

Crispy Sports, “Starbucks Reserve Stainless Steel Tumbler,” Nov. 10, 2015, Amazon.com, www.amazon.com/Starbucks-Reserve-Stainless-Steel-Tumbler/dp/B017TA3S52 (Year: 2015).*

(Continued)

Primary Examiner — Shannon W Morgan
Assistant Examiner — Arva P Adams
 (74) *Attorney, Agent, or Firm* — George C. Rondeau, Jr.;
 Davis Wright Tremaine LLP

(57) **CLAIM**

The ornamental design for a beverage container, as shown and described.

DESCRIPTION

FIG. 1 is a top perspective view of a beverage container showing my new design.
 FIG. 2 is a bottom perspective view thereof.
 FIG. 3 is a front elevational view thereof.
 FIG. 4 is a right side elevational view thereof.
 FIG. 5 is a left side elevational view thereof.
 FIG. 6 is a rear elevational view thereof.
 FIG. 7 is a top plan view thereof.
 FIG. 8 is a bottom plan view thereof.
 FIG. 9 is a top perspective view of a second embodiment thereof.
 FIG. 10 is a bottom perspective view thereof.
 FIG. 11 is a front elevational view thereof.
 FIG. 12 is a right side elevational view thereof.
 FIG. 13 is a left side elevational view thereof.
 FIG. 14 is a rear elevational view thereof.
 FIG. 15 is a top plan view thereof; and,
 FIG. 16 is a bottom plan view thereof.
 The broken lines depict portions of the beverage container that form no part of the claimed design.

1 Claim, 14 Drawing Sheets

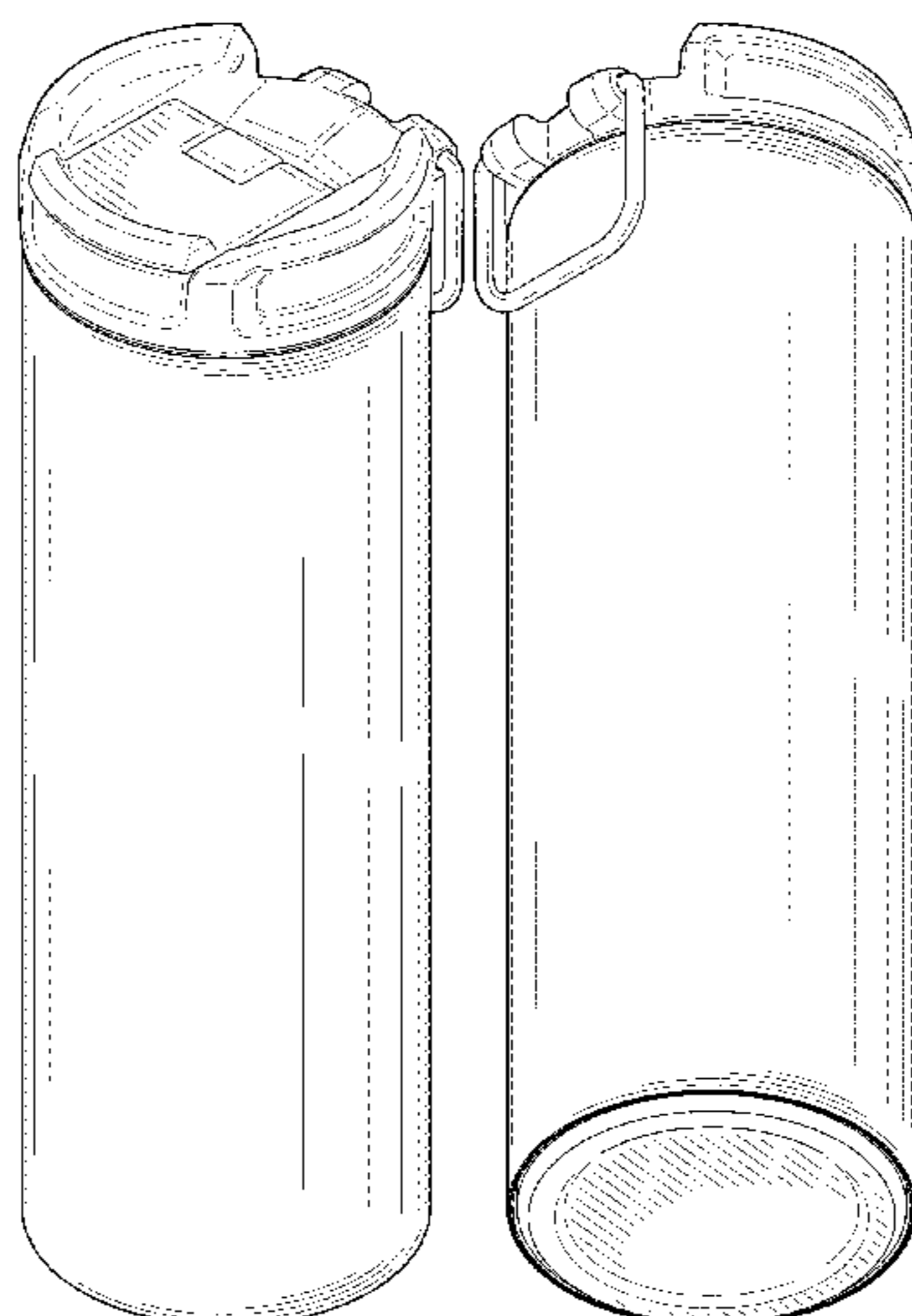

(58) **Field of Classification Search**

CPC A47G 21/184; A47G 21/185; A47G 23/0216; A47G 23/0241; A47G 23/0258; A47J 41/0077; A47J 41/0088; A47J 43/042; B65D 1/265; B65D 51/245; B65D 51/28; B65D 77/0493; B65D 81/3865

See application file for complete search history.

FOREIGN PATENT DOCUMENTS

CN	304669731	6/2018
CN	304721039	7/2018
CN	304891096	11/2018
CN	305030847	2/2019
CN	305225453	* 6/2019
CN	305248328	7/2019
EP	0030070870001	5/2016
EP	0030070870003	5/2016
EP	0026185870001	7/2016
GB	9006354742-0001	3/2019
GB	9007706007-0001	* 2/2020
GB	9007706007-0005	2/2020
GB	90077060070011	2/2020
JP	2020003446 A	1/2020
JP	2020003447 A	1/2020
KR	300816192.0000	9/2015
KR	300845319.0000	* 3/2016
KR	300946782.0000	* 3/2018
KR	300847955.0000	* 8/2018
KR	3010111130000	6/2019
KR	3010990540002	* 3/2021
MY	1334201010001	3/2013

(56) **References Cited**

U.S. PATENT DOCUMENTS

2,493,751	A	1/1950	Davis	
2,587,237	A	2/1952	Sinaiko	
D239,754	S	5/1976	Yoder	
D257,524	S	11/1980	Heinrich	
D264,537	S	5/1982	Myodo	
D290,325	S	6/1987	Ritman	
D306,111	S	2/1990	Fleming et al.	
4,984,707	A	1/1991	Fierthaler	
5,570,797	A	11/1996	Yeh	
D404,241	S	1/1999	Bagley	
D465,132	S	11/2002	Janky et al.	
D476,528	S	7/2003	Janky et al.	
D604,103	S	* 11/2009	Alviar	D7/510
D608,140	S	1/2010	Gilbert	
D609,054	S	* 2/2010	Gilbert	D7/510
D617,608	S	6/2010	Yang et al.	
D623,475	S	9/2010	Aamoudse et al.	
D644,060	S	* 8/2011	Komeiji	D7/392.1
D651,853	S	* 1/2012	Eyal	D7/510
D654,762	S	2/2012	Gilbert	
D660,081	S	* 5/2012	Gilbert	D7/509
D696,900	S	* 1/2014	George	D7/392.1
D707,492	S	* 6/2014	George	D7/510
D717,115	S	* 11/2014	Lane	D7/511
D721,540	S	* 1/2015	Grcic	D7/511
D741,655	S	* 10/2015	Whelan	D7/510
D746,156	S	12/2015	Bondioli et al.	
D751,341	S	3/2016	Seiders et al.	
D756,712	S	5/2016	Kushner	
D780,533	S	3/2017	Seiders et al.	
D787,888	S	5/2017	Joseph	
D789,737	S	* 6/2017	Eyal	D7/396.2
D795,643	S	8/2017	Barlow	
D804,905	S	12/2017	Seiders et al.	
D814,243	S	4/2018	Pape	
D819,402	S	* 6/2018	Silsby	D7/510
D820,044	S	6/2018	Jenkins et al.	
D821,137	S	* 6/2018	Boroski	D7/392.1
D822,427	S	* 7/2018	Sorensen	D7/392.1
D822,498	S	7/2018	Sutcliffe	
D828,093	S	* 9/2018	Chitayat	D7/507
D832,050	S	10/2018	Diener et al.	
D836,395	S	* 12/2018	Seiders	D7/510
D839,049	S	1/2019	Seiders et al.	
D842,028	S	3/2019	Melanson et al.	
D842,038	S	3/2019	Seiders et al.	
D844,382	S	* 4/2019	Seiders	D7/510
D844,383	S	* 4/2019	Seiders	D7/510
D850,205	S	* 6/2019	Hotell	D7/507
D856,069	S	* 8/2019	Barber	D7/392.1
D857,443	S	8/2019	Hill	
D861,415	S	* 10/2019	Seiders	D7/392.1
D880,941	S	* 4/2020	Silsby	D7/510
D882,343	S	4/2020	Rane et al.	
D884,425	S	* 5/2020	Burns	D7/510
D885,834	S	6/2020	Pawluskiewicz et al.	
D886,514	S	* 6/2020	Kander	D7/392.1
D890,573	S	7/2020	Jacobsen	
D899,862	S	10/2020	Rane et al.	
D911,778	S	* 3/2021	Jacobsen	D7/511
D921,433	S	6/2021	Gronkowski	
D923,408	S	* 6/2021	Hamilton	D7/510
2016/0150901	A1	6/2016	Chang et al.	
2018/0206660	A1	7/2018	Heiman	
2018/0310766	A1	11/2018	Lapsker	

OTHER PUBLICATIONS

Total Tea, "Travel Coffee Mug or Ice Tea Tumbler," Feb. 13, 2016, Amazon.com, www.amazon.com/Tea-Tumbler-Insulated-Stainless-Guarantee/dp/B01BSVJBQI?th=1 (Year: 2016).*

Amazon.com, "Contigo Vacuum-Insulated Stainless Steel TwistSeal Glaze Travel Mug," Jan. 11, 2017, Amazon.com, www.amazon.com/Contigo-Vacuum-Insulated-Stainless-TwistSeal-Weather/dp/B01N32WQ8D (Year: 2017).*

EcoVessel, "EcoVessel Perk Vacuum Insulated Coffee Tumbler and Tea Bottle," Jul. 12, 2018, Amazon.com, www.amazon.com/dp/B06VTT813R (Year: 2018).*

Klean Kanteen, "Introducing our new #TKWide Kanteens on a little bouldering trip outside of Santa Barbara, CA," May 30, 2019, Facebook, www.facebook.com/kleankanteen/photos/pcb.10156114841921990/10156114841686990/ (Year: 2019).*

The Glass Dispensary, Facebook post, May 9, 2019, Facebook, www.facebook.com/theglassdispensary/photos/863452694031517 (Year: 2019).*

REI, "Stanley Stay-Hot Titanium Travel Mug Video," Sep. 9, 2020, YouTube, www.youtube.com/watch?v=-0h6AMs1Eb4 (Year: 2020).*

Off-Road Group, "Stanley Titanium Travel Mug," Retrieved Oct. 12, 2021, <https://offroad.md/en/mugs-cups/762-stanley-titanium-travel-mug-14-oz.html> (Year: 2021).*

Otterbox, "Otterbox Elevation Tumbler Basic Lid, 10 oz/20 oz," Amazon webpage, www.4imprint.com/product/146044/Koozie-Vacuum-Insulator-Tumbler-11-oz, Jan. 2019, 2 pages.

ART_RICH, "Stainless steel, metal cup isolated on white background stock photo," iStock, www.istockphoto.com/photo/stainless-steel-metal-cup-isolated-on-white-background-gm1172004287-324924478, Sep. 9, 2019, 2 pages.

Brumate, "Brumate Imperial Pint," Amazon.com, www.amazon.com/dp/B07N B9TB1Y, Jan. 31, 2019, 4 pages.

Civago, "Civago Stainless Steel Coffee Mug Cup with Handle," Amazon.com, www.amazon.com/dp/B07TZ24CQV, Aug. 7, 2019, 2 pages.

Daniel, "Otterbox Elevation Stainless Steel Wine Tumbler with Lid," Gatgentsin, <https://gadgetsin.com/otterbox-elevation-stainless-steel-wine-tumbler-with-lid.htm>, Jun. 25, 2019, 2 pages.

EcoVessel, "EcoVessel Transit-Kaffeetasse Mit Schiebedeckel Und Ergonomischem Griff," Amazon.de, www.amazon.de/dp/B085NHY2DQ/, May 2, 2020, 2 pages.

(56)

References Cited

OTHER PUBLICATIONS

Gteller, "Gtell 10oz Lowball Tumbler," Amazon.com, www.amazon.com/Gtell-10oz-lowball-tumbler-stainless-insulated/dp/B0743CCDKM, Jul. 20, 2017, 2 pages.

MiiR, "MiiR Camp Cup Vacuum Insulated Tumbler with Lid," Amazon.com, www.amazon.ca/dp/B0728969NR, Jun. 23, 2017, 3 pages.

Netrush, "MiiR Men's 12oz Camp Cup," Amazon.com, www.amazon.com/dp/B0725PHJ68, Jun. 8, 2017, 2 pages.

OVERLORDInc, "30oz Lid for Yeti Ozark Trails Rocky Mountain and Rtic Tumbler Lid," Amazon.com, www.amazon.com/Trails-Mountain-Tumblers-Friendly-Prestigious/dp/B01NCS3KT8, Jan. 3, 2017, 2 pages.

Pewtersociety.org, Photograph, retrieved from www.pewtersociety.org/sites/default/files/images/2018-12/19thcmugs.jpg, Dec. 2018, 1 page.

PreechaTH, "Cans and Jug Made of Tin Stock Photo," iStock, www.istockphoto.com/photo/cans-and-jug-made-of-tin-gm506830702-84406939, Feb. 2, 2016, 2 pages.

Prime Optimization, "RTIC 12 Ounce Tumbler," Reviewed with photo Jun. 25, 2019, Amazon.com, www.amazon.com/RTIC-SYNCH-KG122107-Lowball-Tumbler-Black/dp/B06Y61GV6V, Apr. 11, 2017, 3 pages.

Stanley, "Titanium Multi Cup | 10 oz," Stanley.com, retrieved from www.stanley1913.com/products/titanium-multi-cup-10-oz, Apr. 2, 2021, 2 pages.

Valtcan, "Valtcan Titanium Mug," Amazon.com, www.amazon.com/Valtcan-Titanium-500ml-Handle-Camping/dp/B07WP83NLB, Nov. 3, 2017, 2 pages.

XWDIRECT LLC, "6 Pack 16 oz Unbreakable Stainless Steel Camping Coffee Mug Drinking Soup Cup," Amazon.com, www.amazon.com/Tsyware-Unbreakable-Stainless-Camping-Drinking/dp/B07N-NZVLR1, Feb. 12, 2019, 2 pages.

* cited by examiner

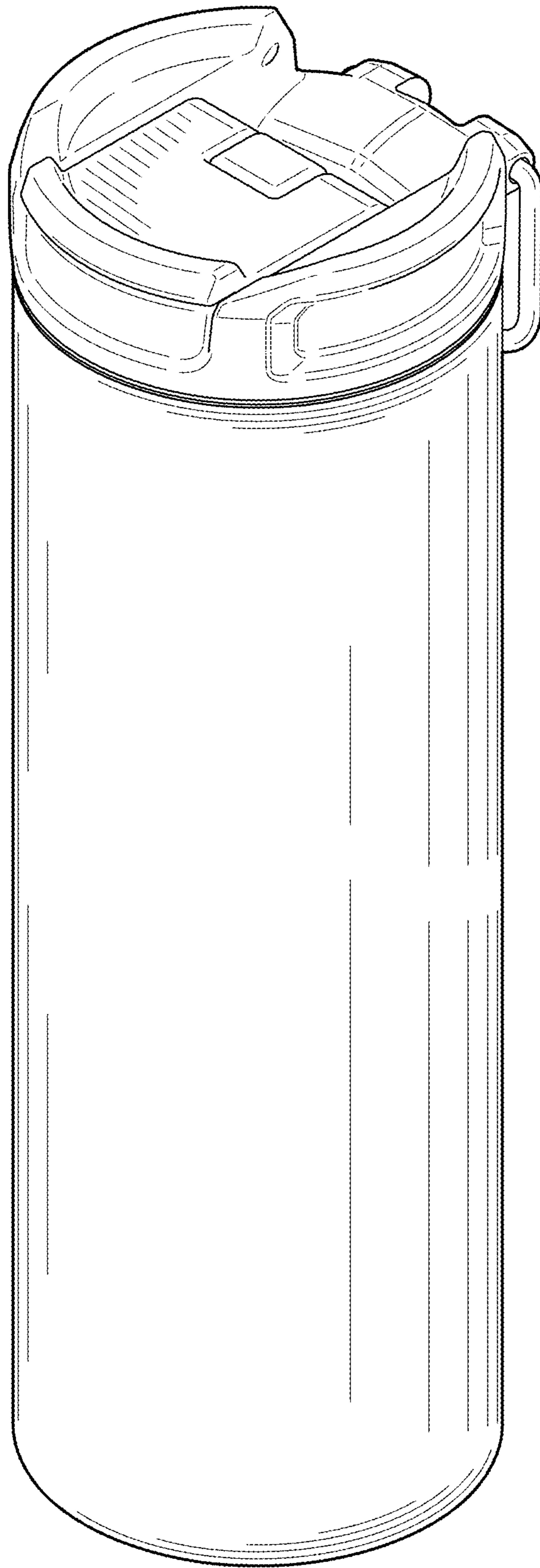

FIG. 1

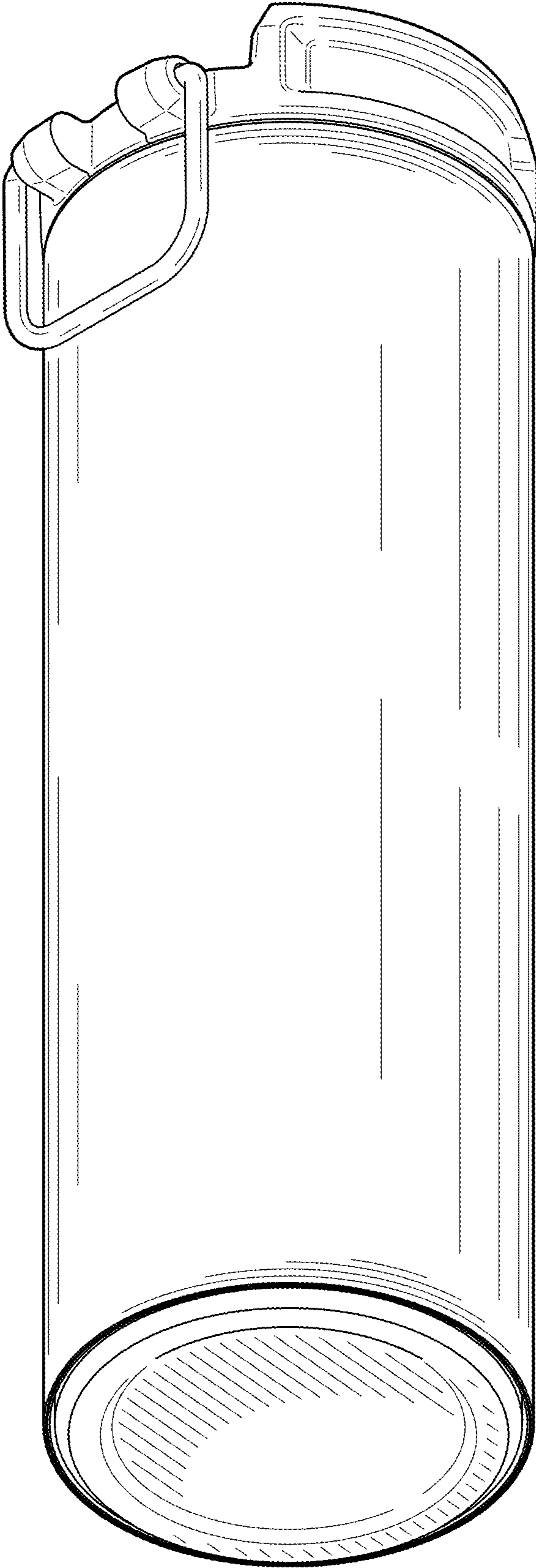

FIG. 2

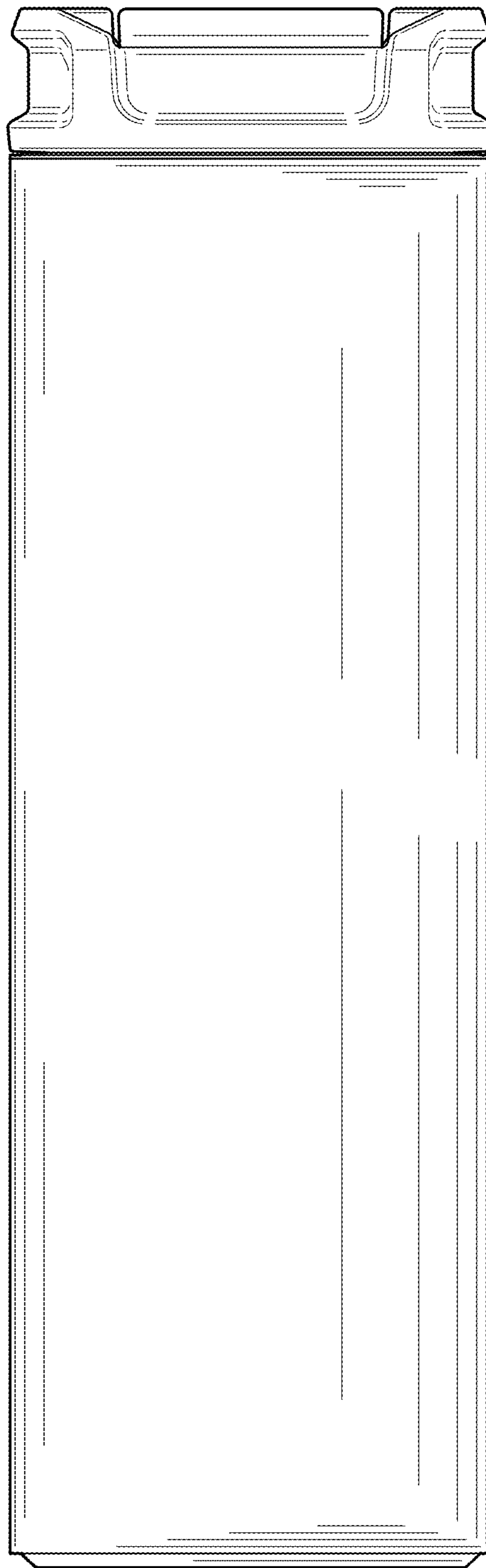

FIG. 3

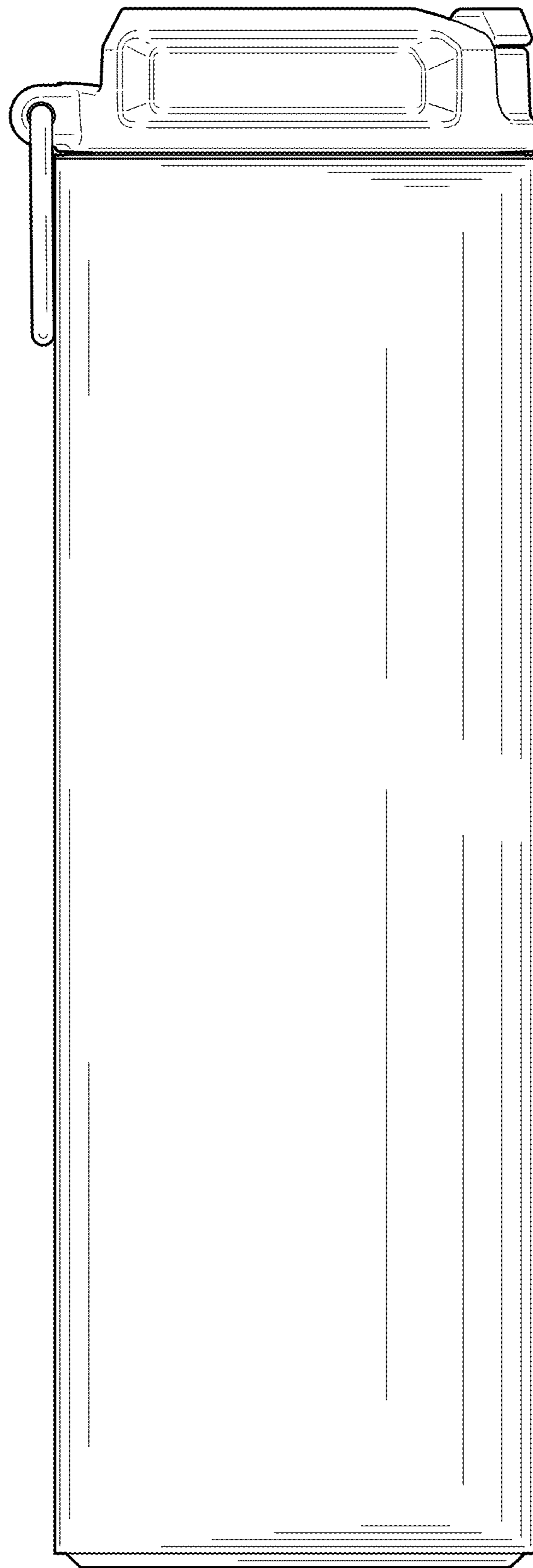

FIG. 4

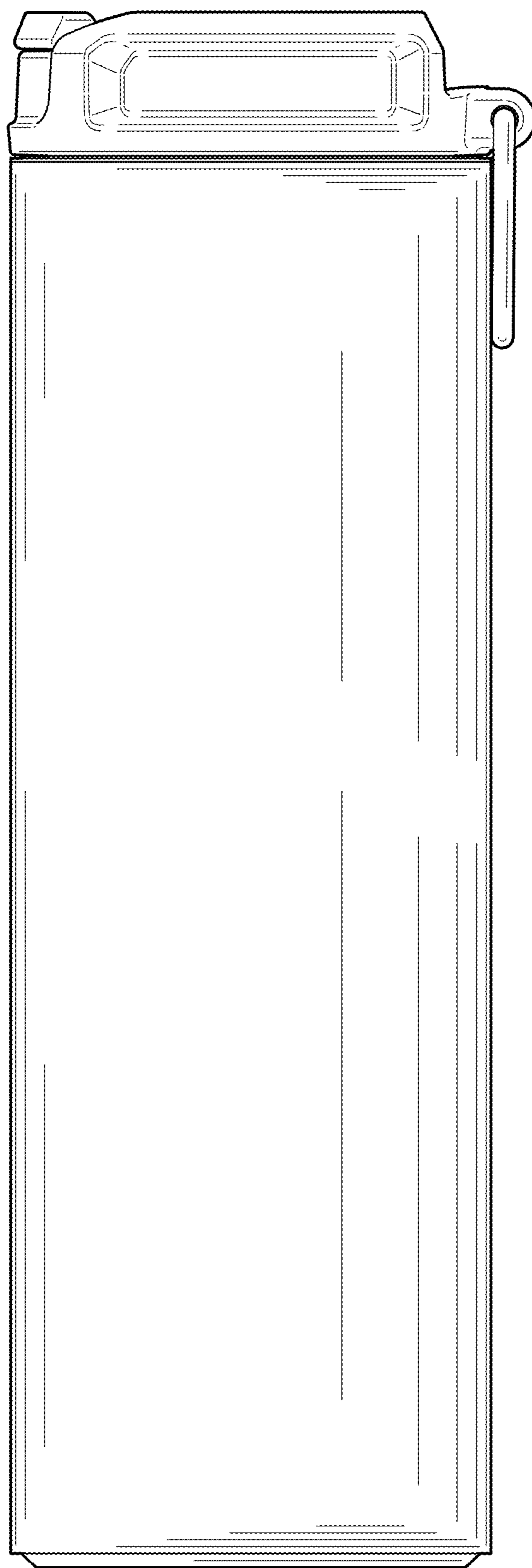

FIG. 5

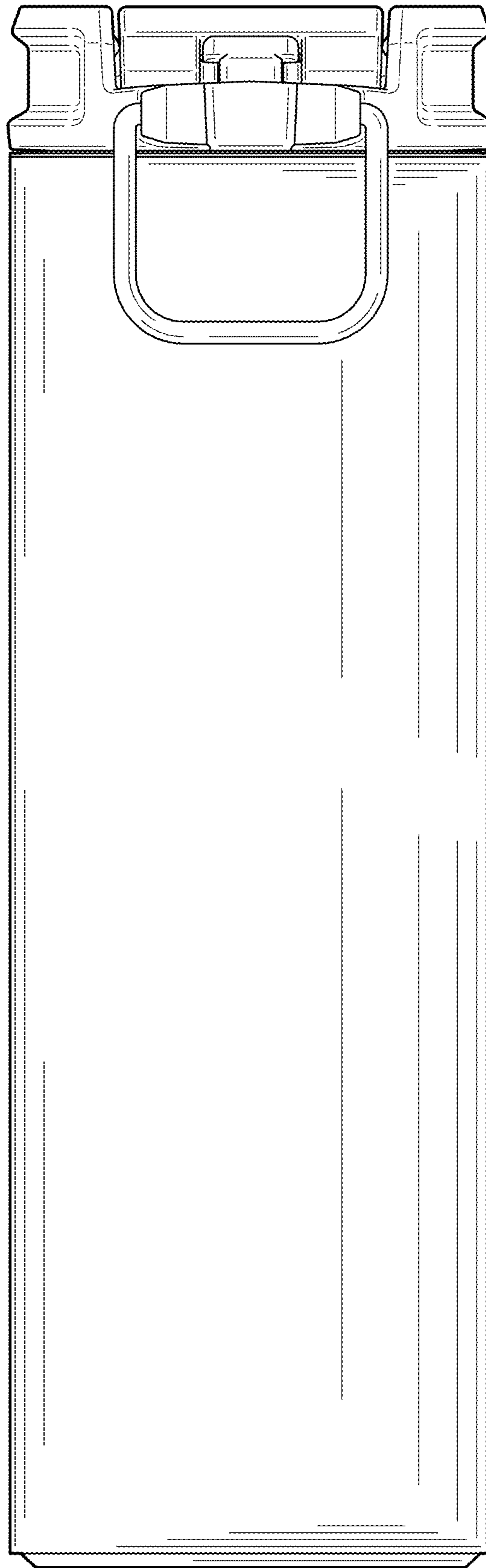

FIG. 6

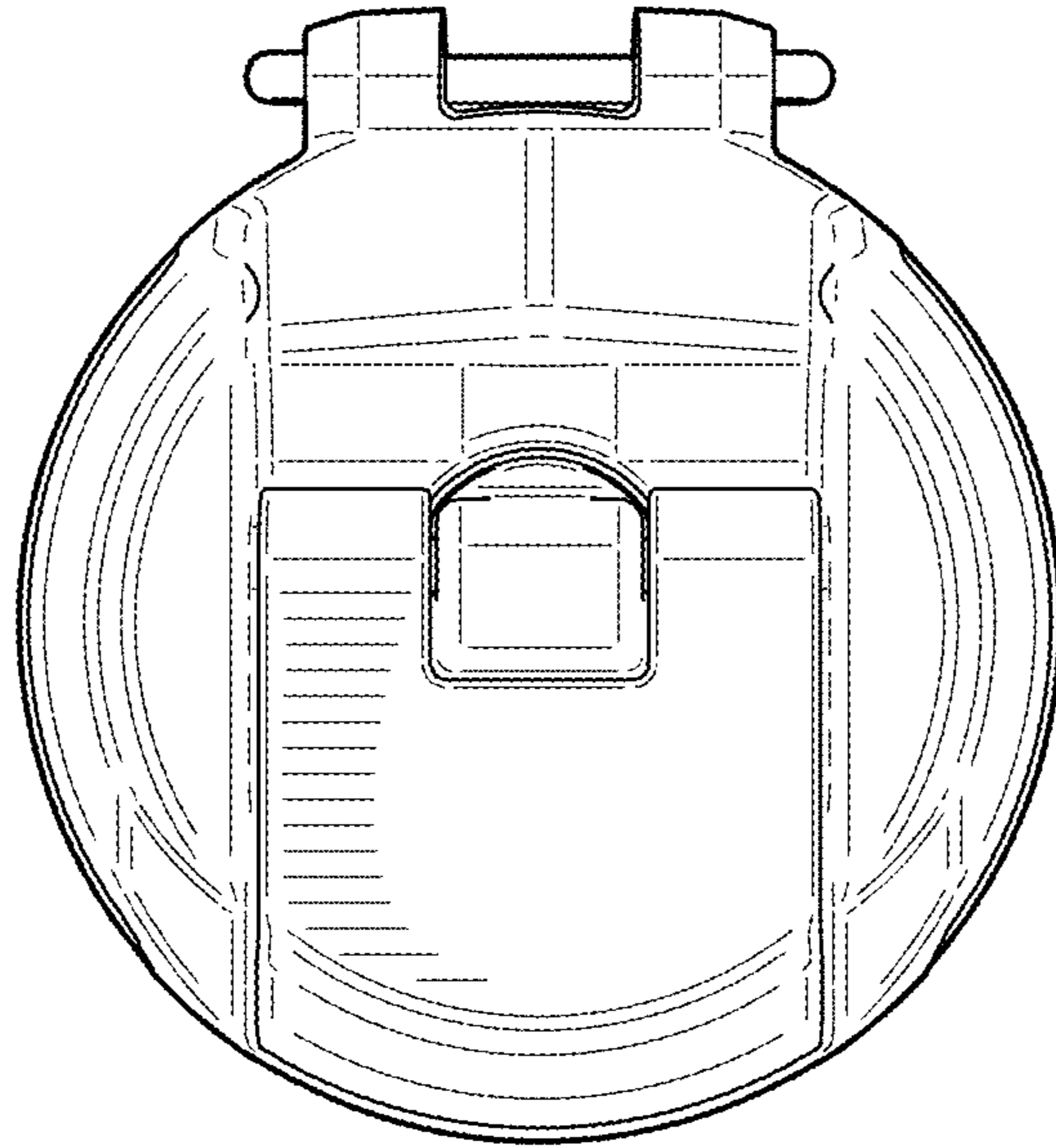

FIG. 7

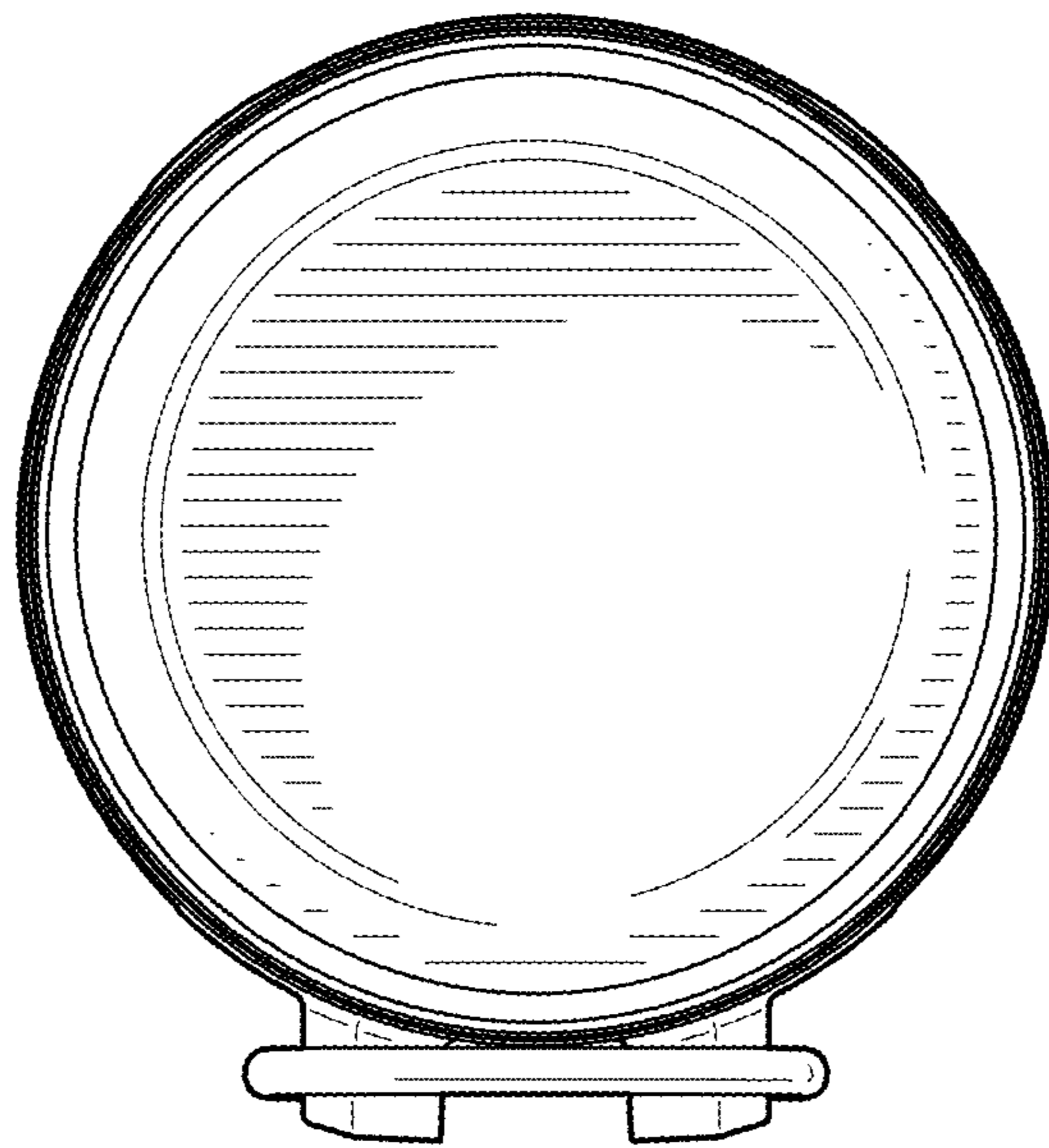

FIG. 8

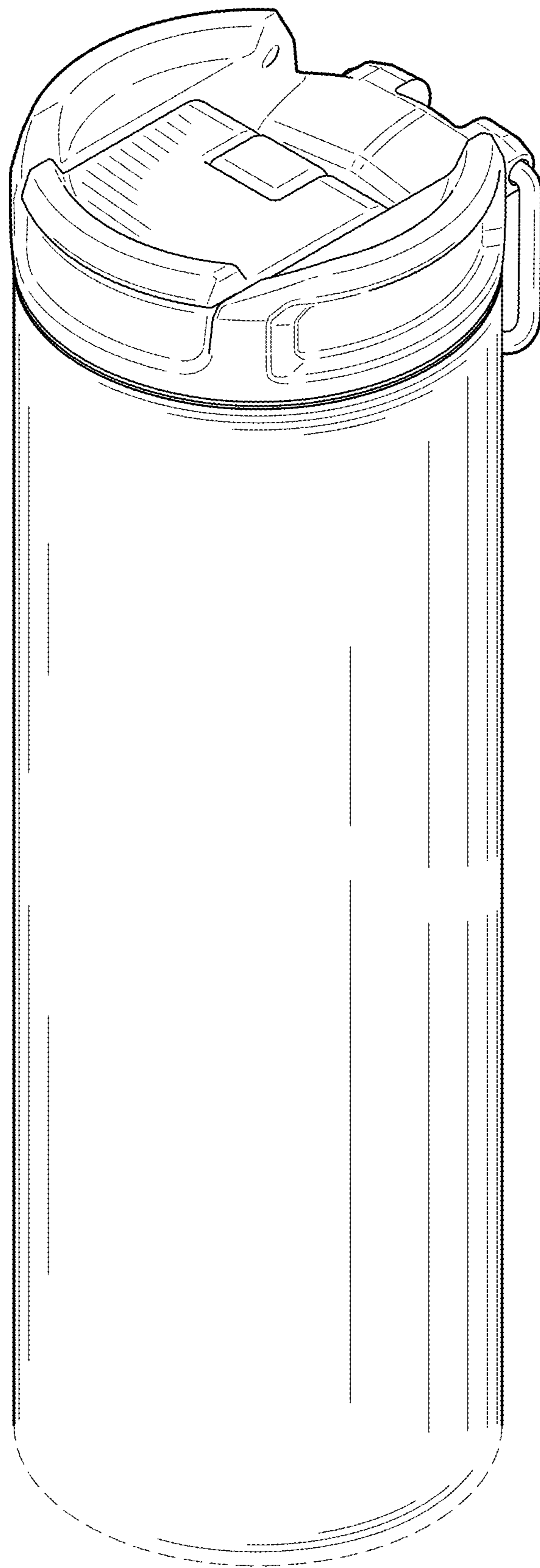

FIG. 9

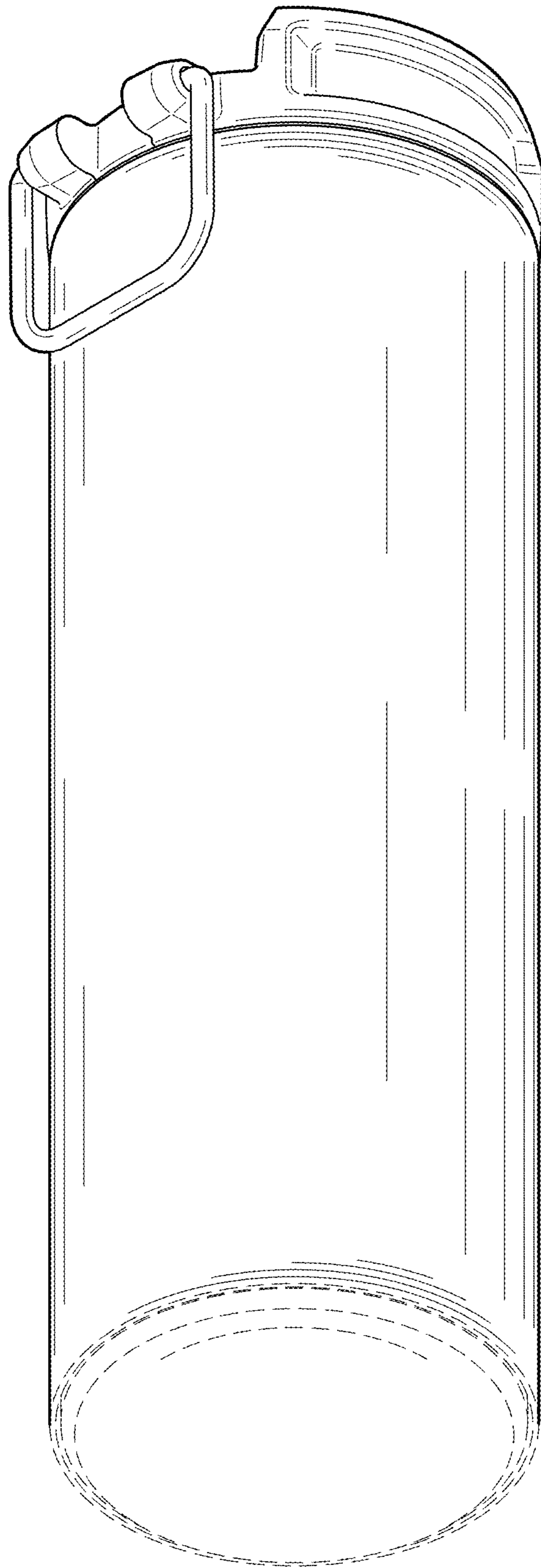

FIG. 10

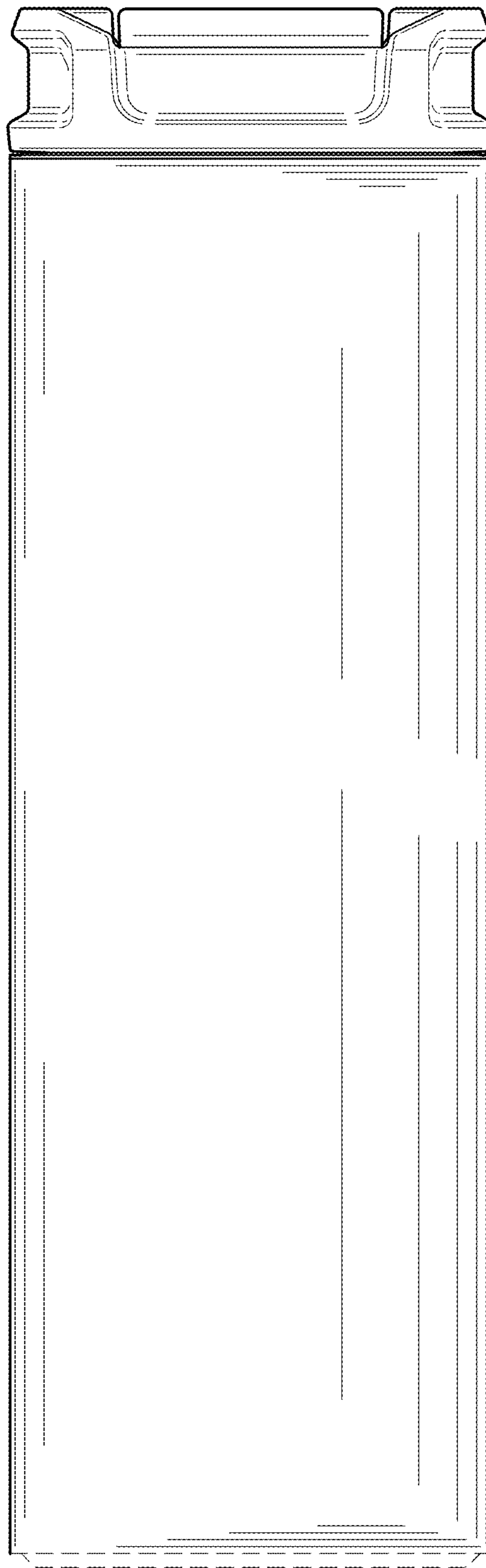

FIG. 11

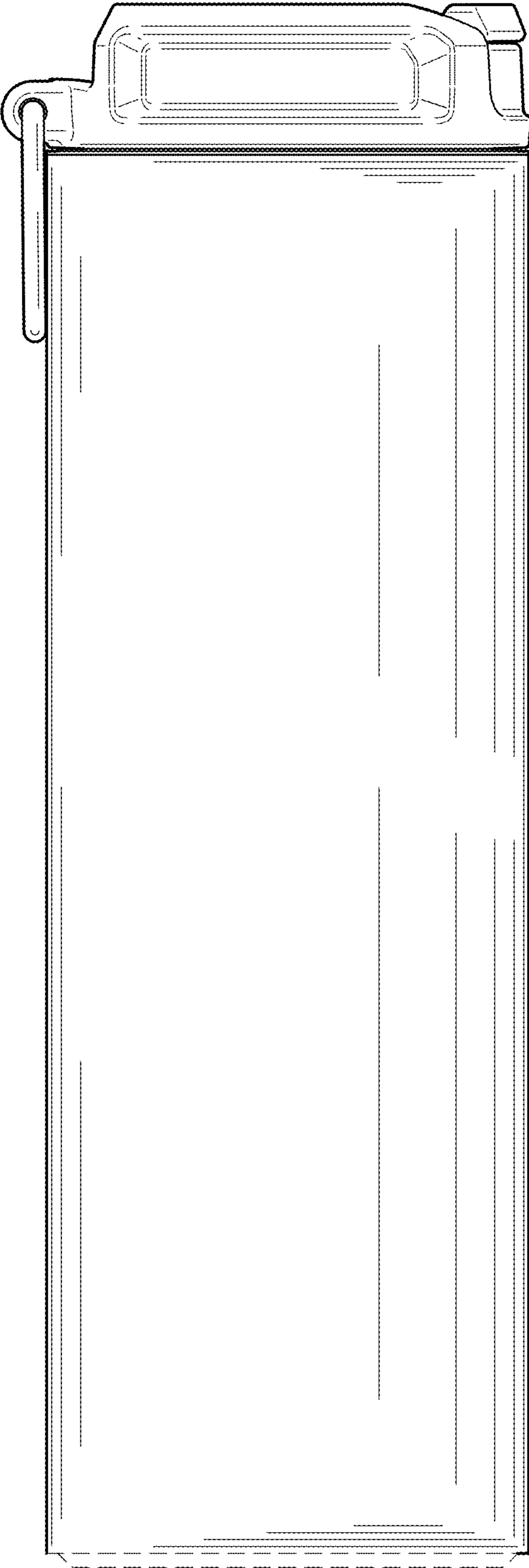

FIG. 12

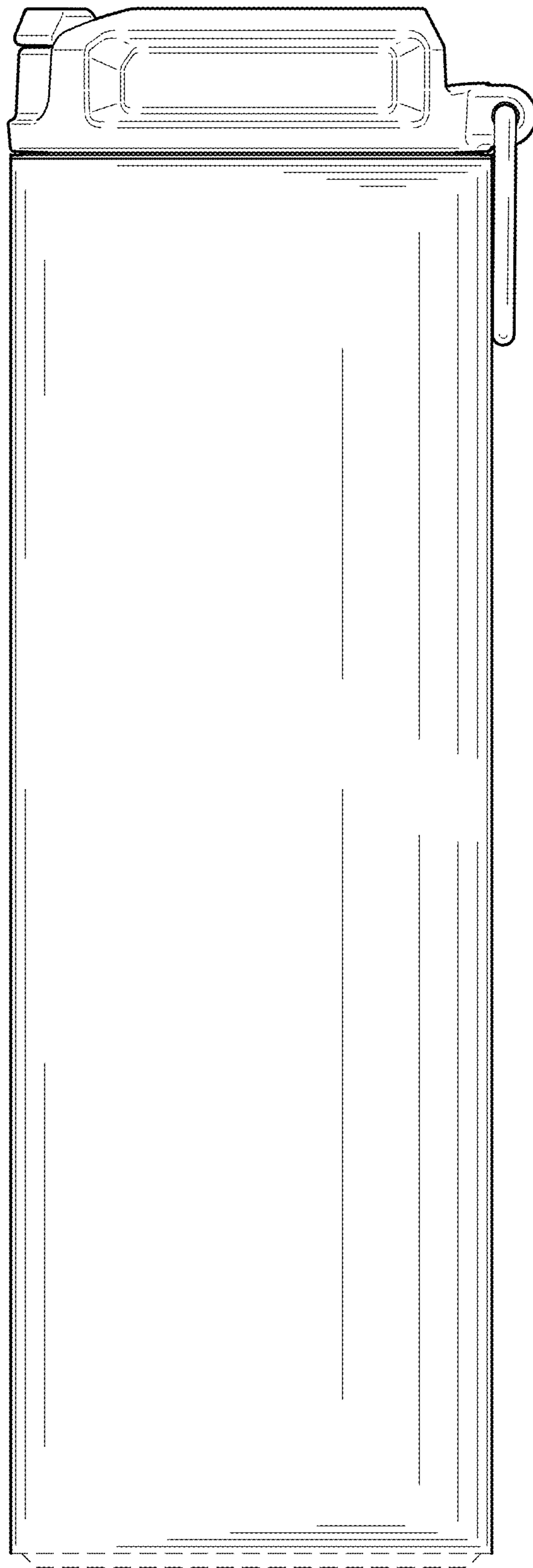

FIG. 13

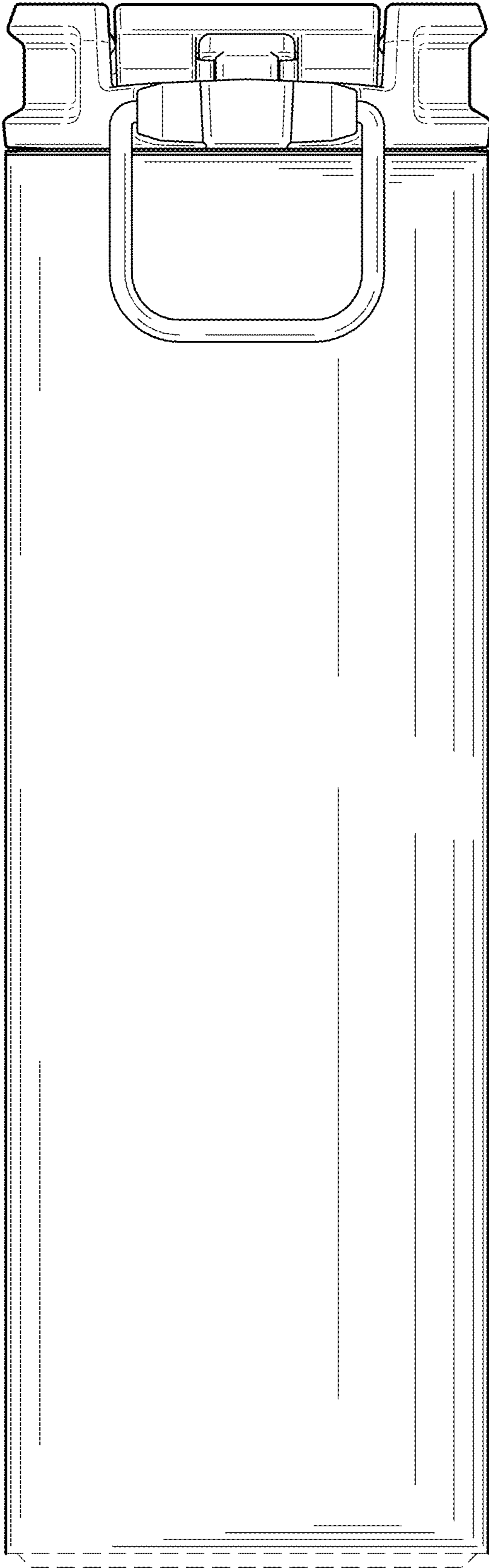

FIG. 14

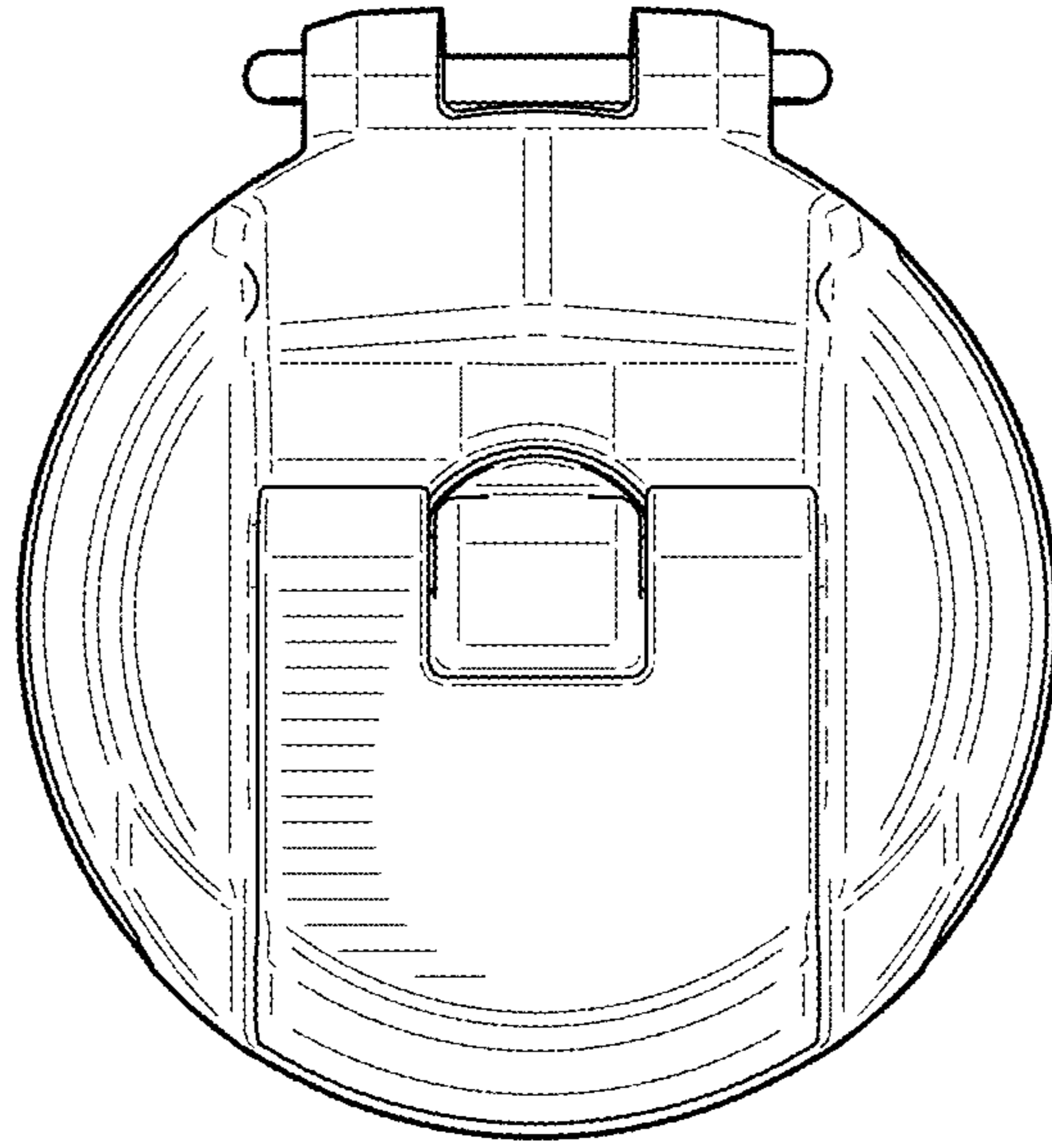

FIG. 15

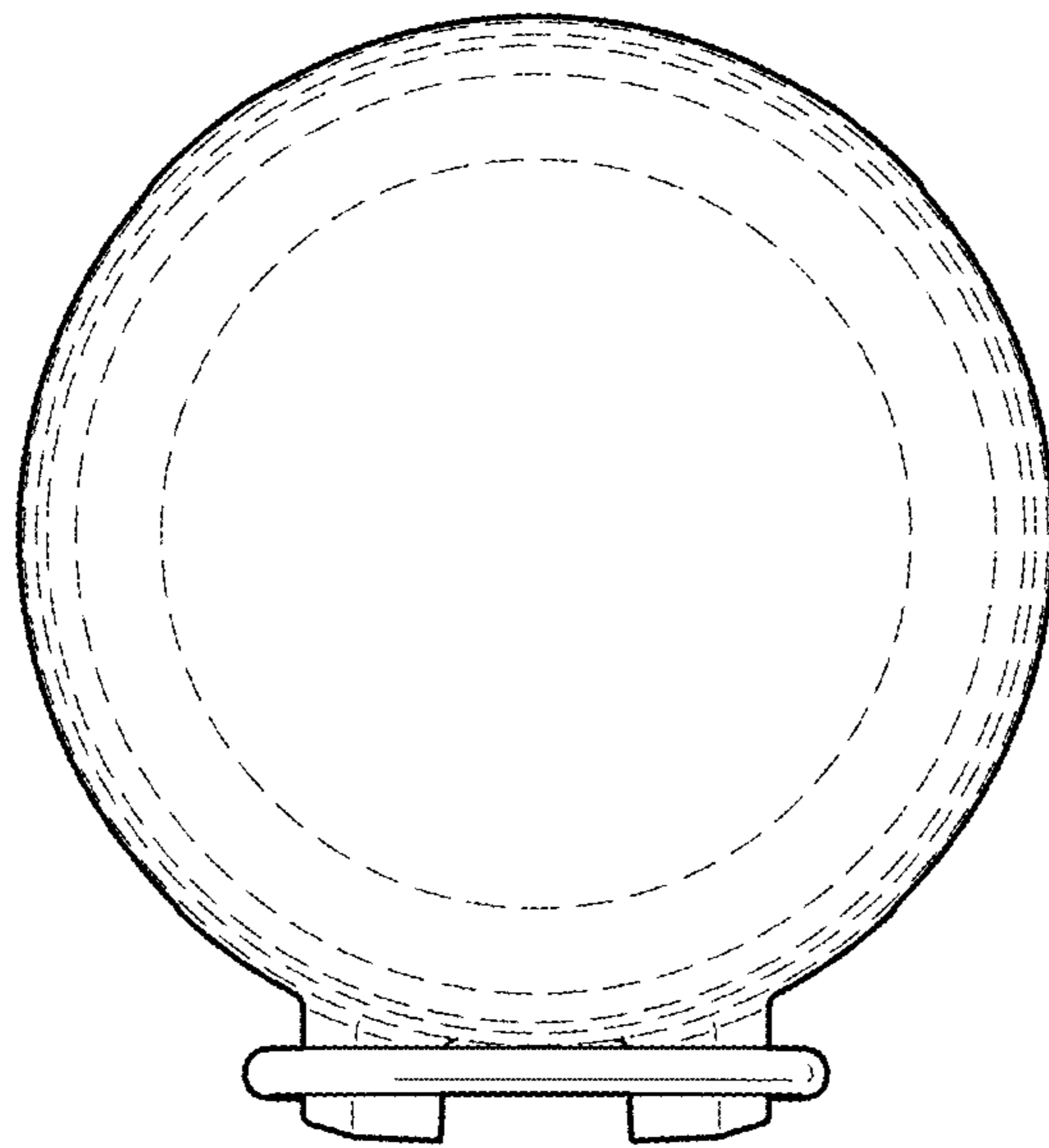

FIG. 16