



US00D952397S

(12) **United States Design Patent** (10) **Patent No.:** **US D952,397 S**
Thies et al. (45) **Date of Patent:** **** May 24, 2022**

(54) **FOOD PROCESSOR BASE**
(71) Applicant: **Vorwerk & Co. Interholding GmbH**,
Wuppertal (DE)
(72) Inventors: **Felix Thies**, Wuppertal (DE); **Jan Delfs**, Bonn (DE)
(73) Assignee: **Vorwerk & Co. Interholding GmbH**
(**) Term: **15 Years**
(21) Appl. No.: **29/762,629**
(22) Filed: **Dec. 17, 2020**
(51) **LOC (13) Cl.** **31-00**
(52) **U.S. Cl.**
USPC **D7/386**; D7/376; D7/378; D7/384
(58) **Field of Classification Search**
USPC D7/326, 358, 360, 372, 376–386,
D7/412–413, 602, 629, 665–666, 669,
D7/679, 693–694
CPC A21C 1/02; A21C 1/04; A23N 1/00; A23N
1/02; A47J 43/04; A47J 43/25; A47J
43/27; A47J 43/042; A47J 43/044; A47J
43/046; A47J 43/075; A47J 43/0722;
A47J 43/0727; B01F 3/00; B01F 3/0807;
B01F 3/0853; B01F 13/0059; B01F
13/0064; B02C 1/08; B02C 2/04; B02C
4/42; B02C 4/142; B02C 4/143; B02C
4/423; B02C 13/1835; B28C 5/10; B28C
5/12; B28C 5/14; B28C 5/16; A23L 5/10
See application file for complete search history.

D847,558 S * 5/2019 Hoff D7/384
D878,143 S * 3/2020 Ding D7/358
D896,567 S * 9/2020 Bai D7/384
D899,843 S * 10/2020 Ye D7/384
D925,273 S * 7/2021 Yao D7/384

(Continued)

Primary Examiner — Ricky Pham
(74) *Attorney, Agent, or Firm* — Barnes & Thornburg
LLP

(57) **CLAIM**

The ornamental design for a food processor base, as shown
and described.

DESCRIPTION

FIG. 1 is a perspective view of a first embodiment of an
ornamental design for a food processor base showing our
new design;
FIG. 2 is a front plan view thereof;
FIG. 3 is a left side plan view thereof;
FIG. 4 is a right side plan view thereof;
FIG. 5 is a rear plan view thereof;
FIG. 6 is a top plan view thereof; and
FIG. 7 is a bottom plan view thereof.
FIG. 8 is a perspective view of a second embodiment of an
ornamental design for a food processor base
FIG. 9 is a front plan view thereof;
FIG. 10 is a left side plan view thereof;
FIG. 11 is a right side plan view thereof;
FIG. 12 is a rear plan view thereof;
FIG. 13 is a top plan view thereof; and
FIG. 14 is a bottom plan view thereof.
FIG. 15 is a perspective view of a third embodiment of an
ornamental design for a food processor base
FIG. 16 is a front plan view thereof;
FIG. 17 is a right side plan view thereof;
FIG. 18 is a left side plan view thereof;
FIG. 19 is a rear side plan view thereof; and
FIG. 20 is a top plan view thereof; and,
FIG. 21 is a bottom plan view thereof.

1 Claim, 21 Drawing Sheets

(56) **References Cited**

U.S. PATENT DOCUMENTS

3,176,968 A * 4/1965 Appleton A47J 43/046
366/146
D638,653 S * 5/2011 Borin D7/326
D745,316 S * 12/2015 Usmar D7/378
D761,613 S * 7/2016 Moon D7/360
D761,615 S * 7/2016 Dickson, Jr. D7/376

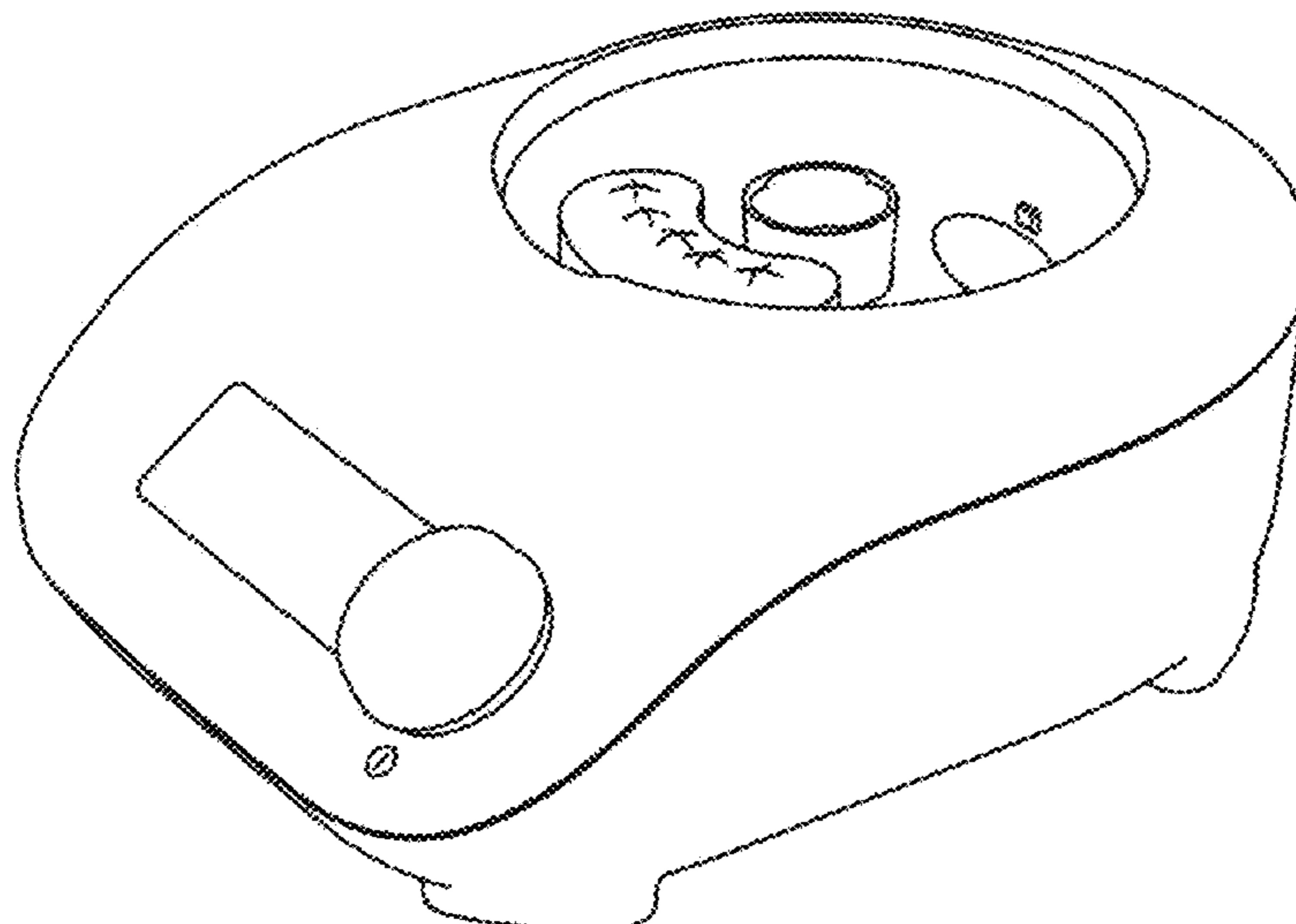

(56)

References Cited

U.S. PATENT DOCUMENTS

D935,261 S * 11/2021 Ye D7/384
2002/0027175 A1* 3/2002 Capp A47J 43/046
241/199.12
2018/0333004 A1* 11/2018 De' Longhi A23L 5/10

* cited by examiner

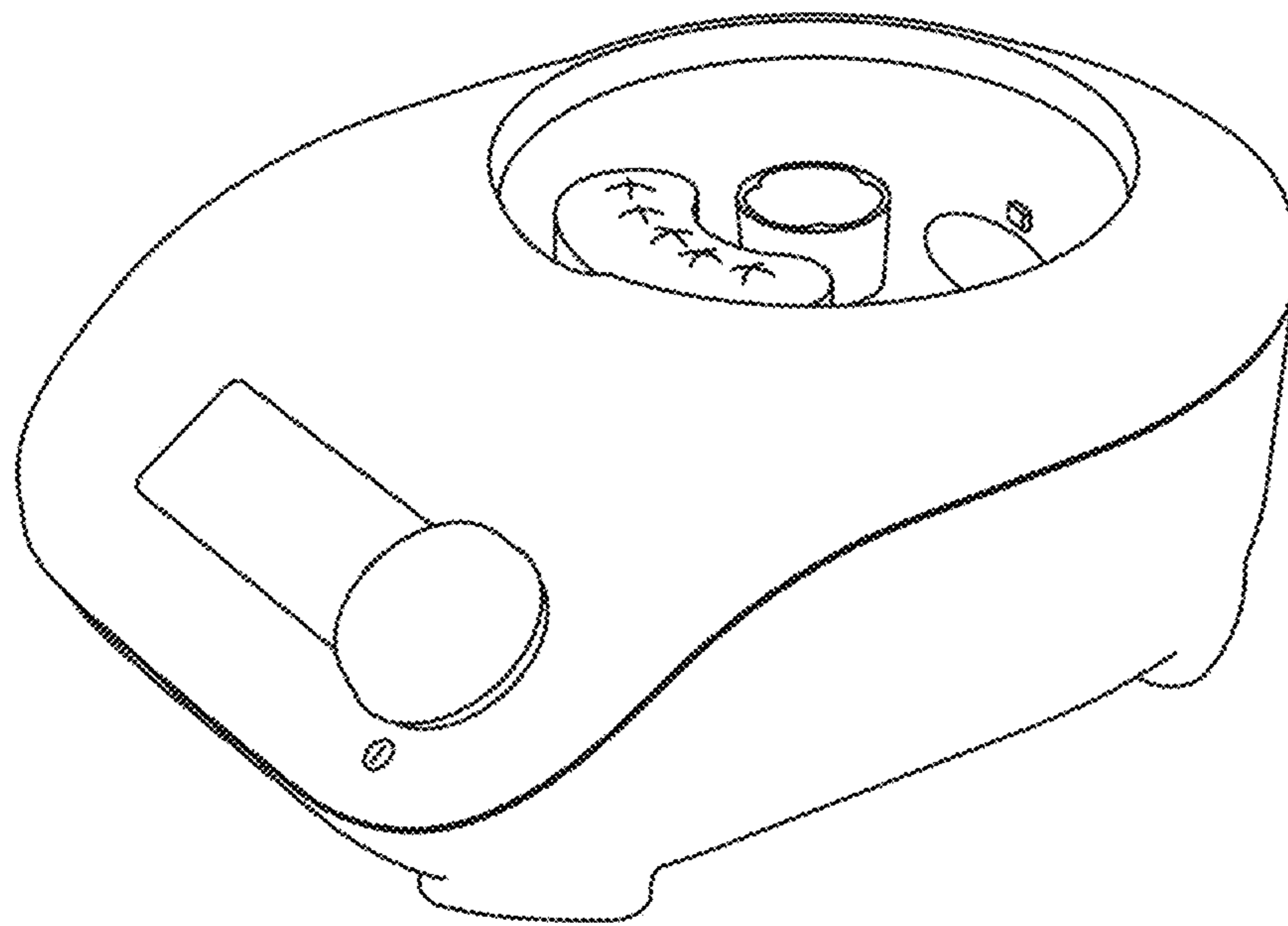

FIG. 1

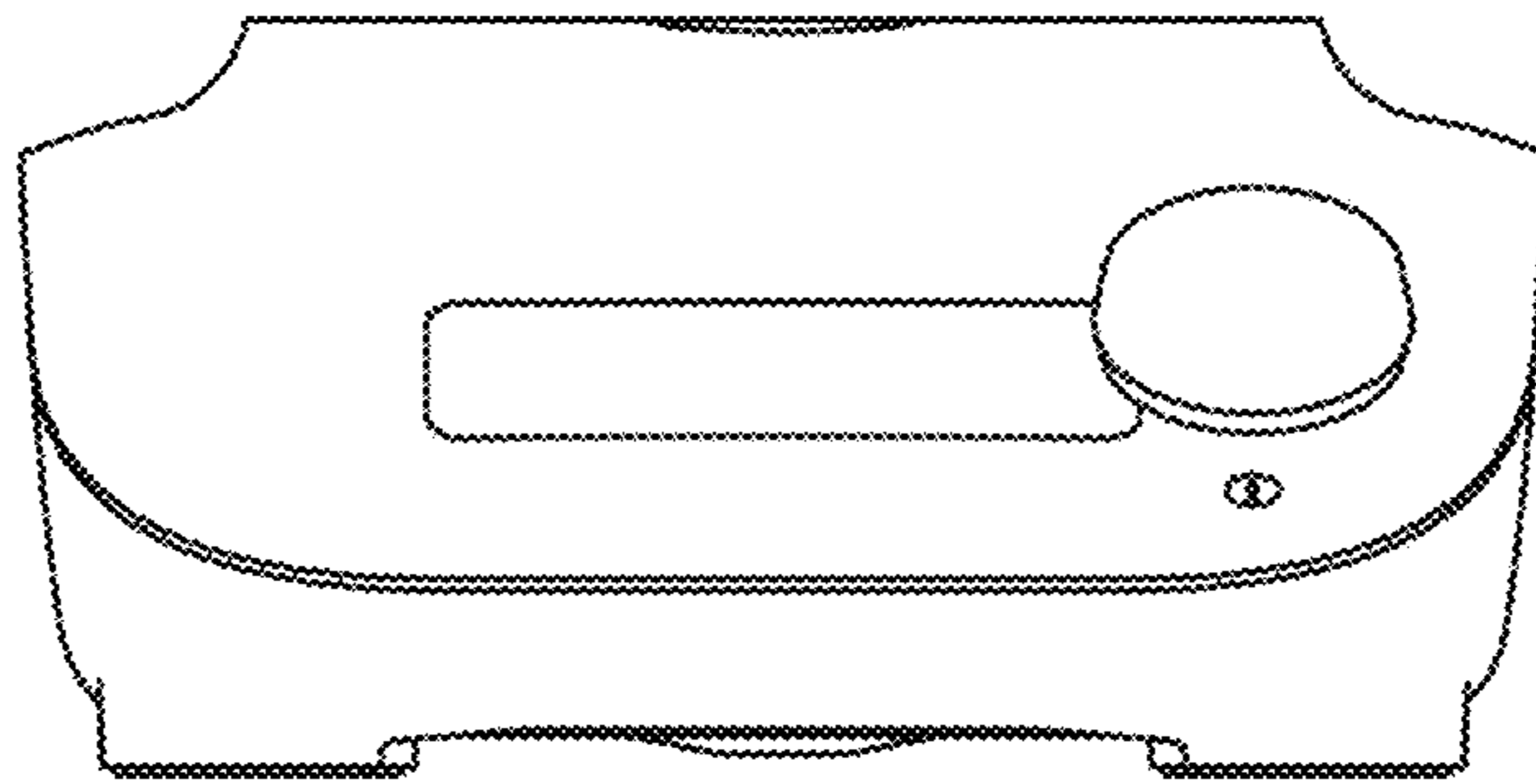

FIG. 2

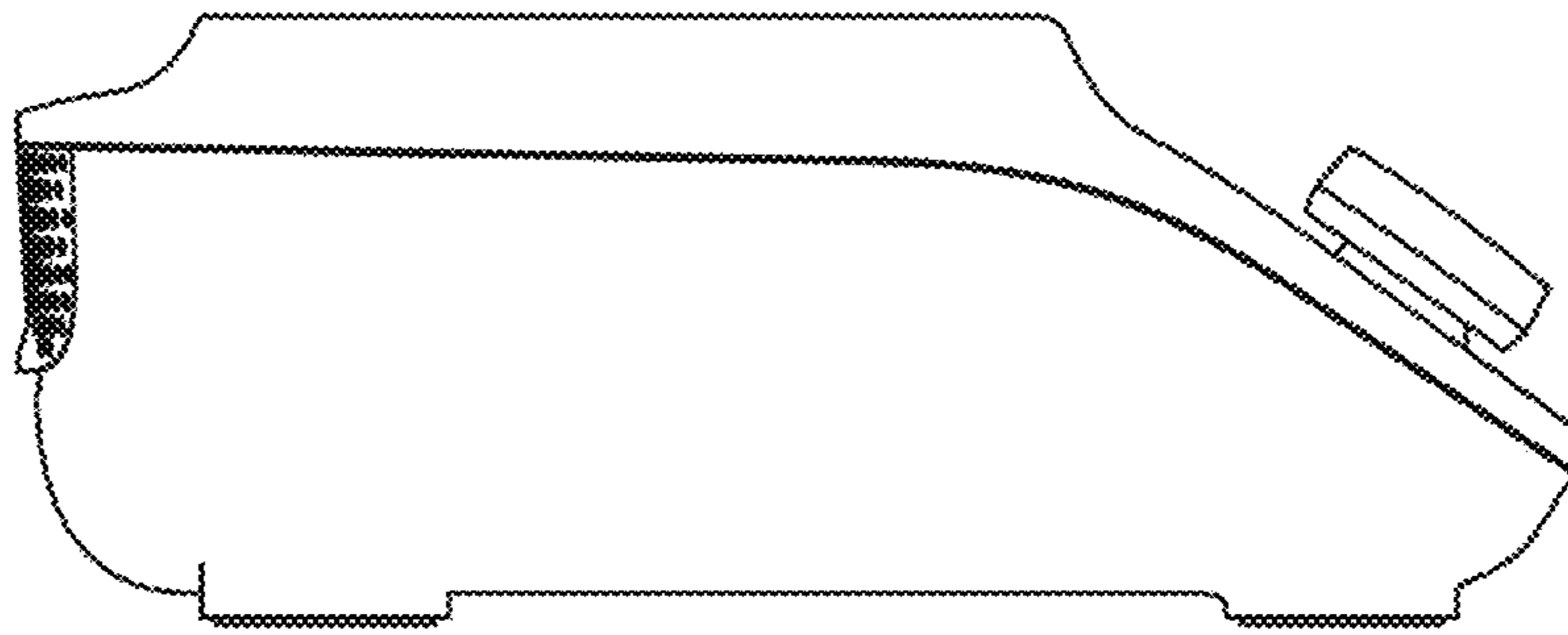

FIG. 3

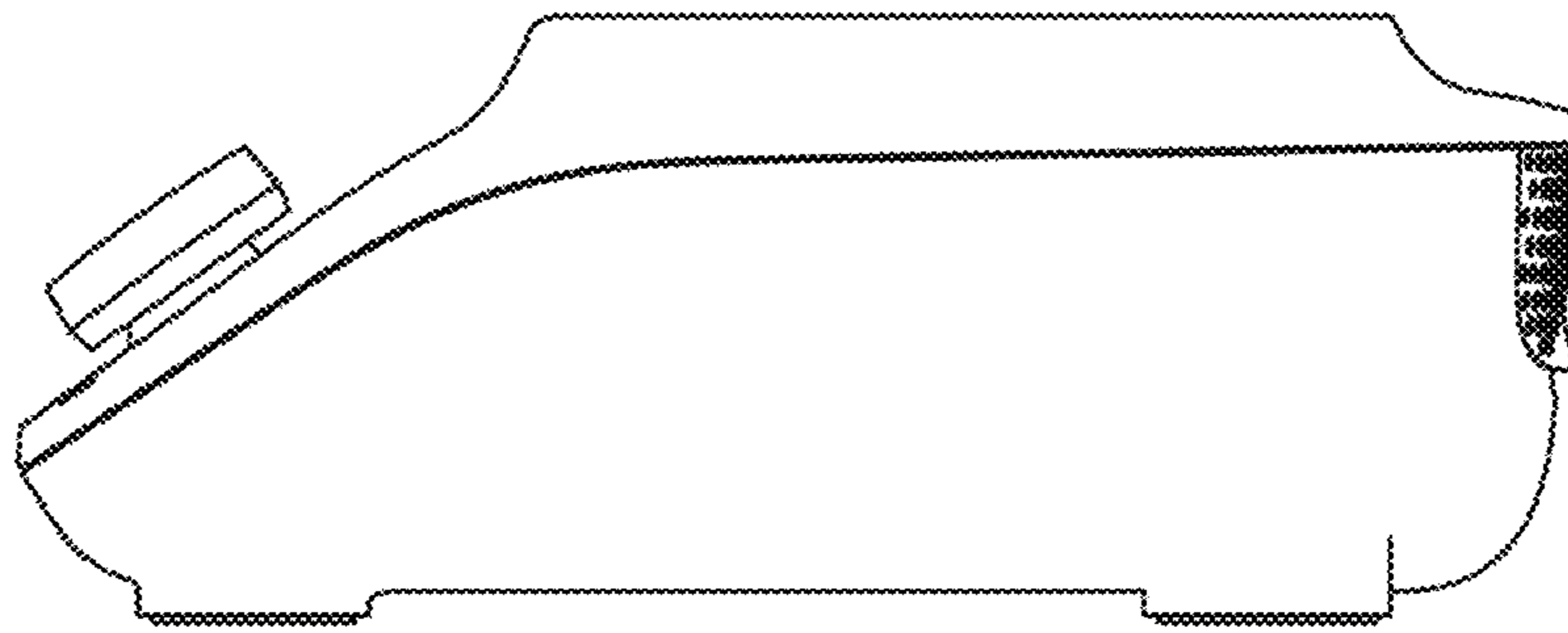

FIG. 4

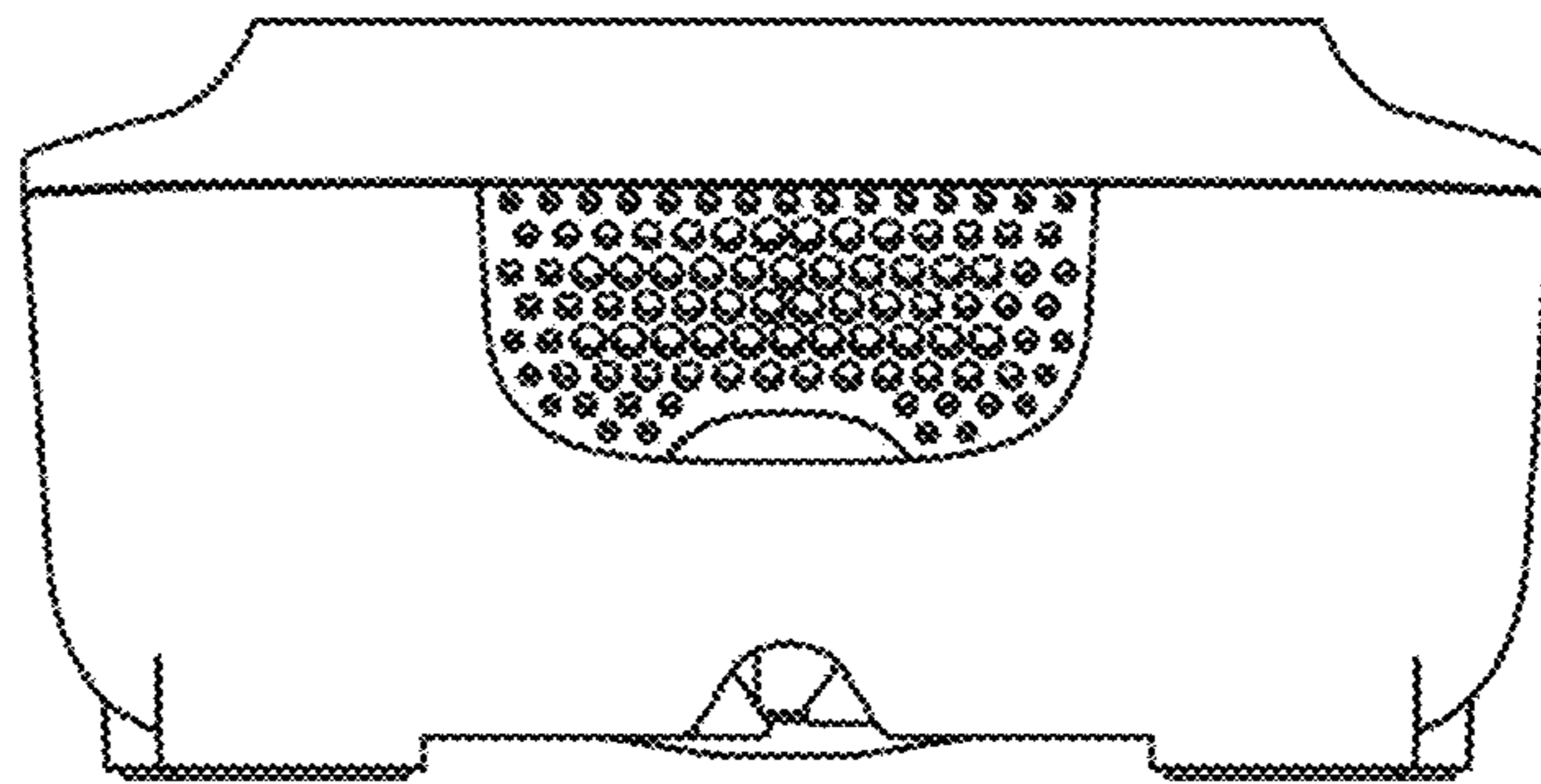

Fig. 5

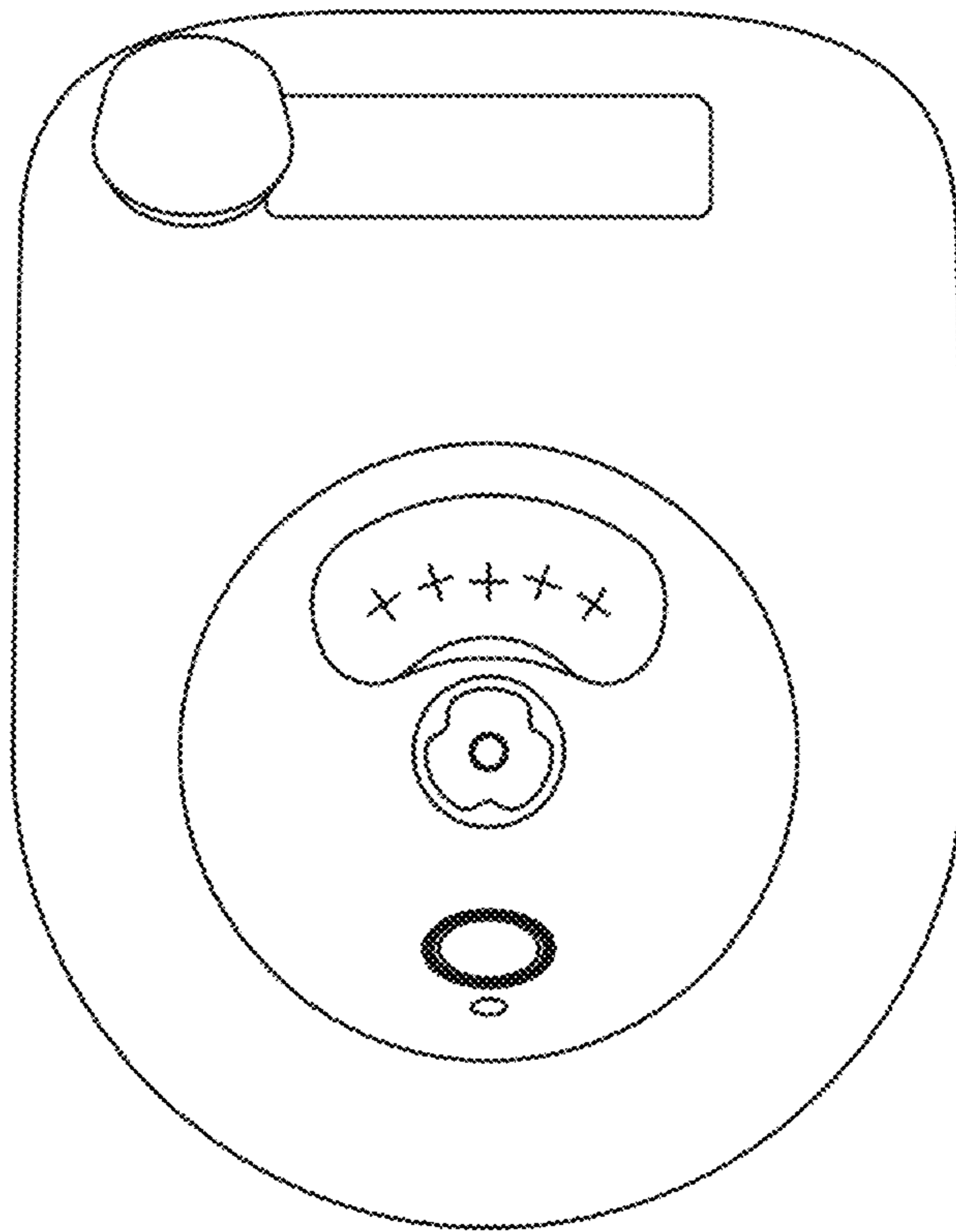

FIG. 6

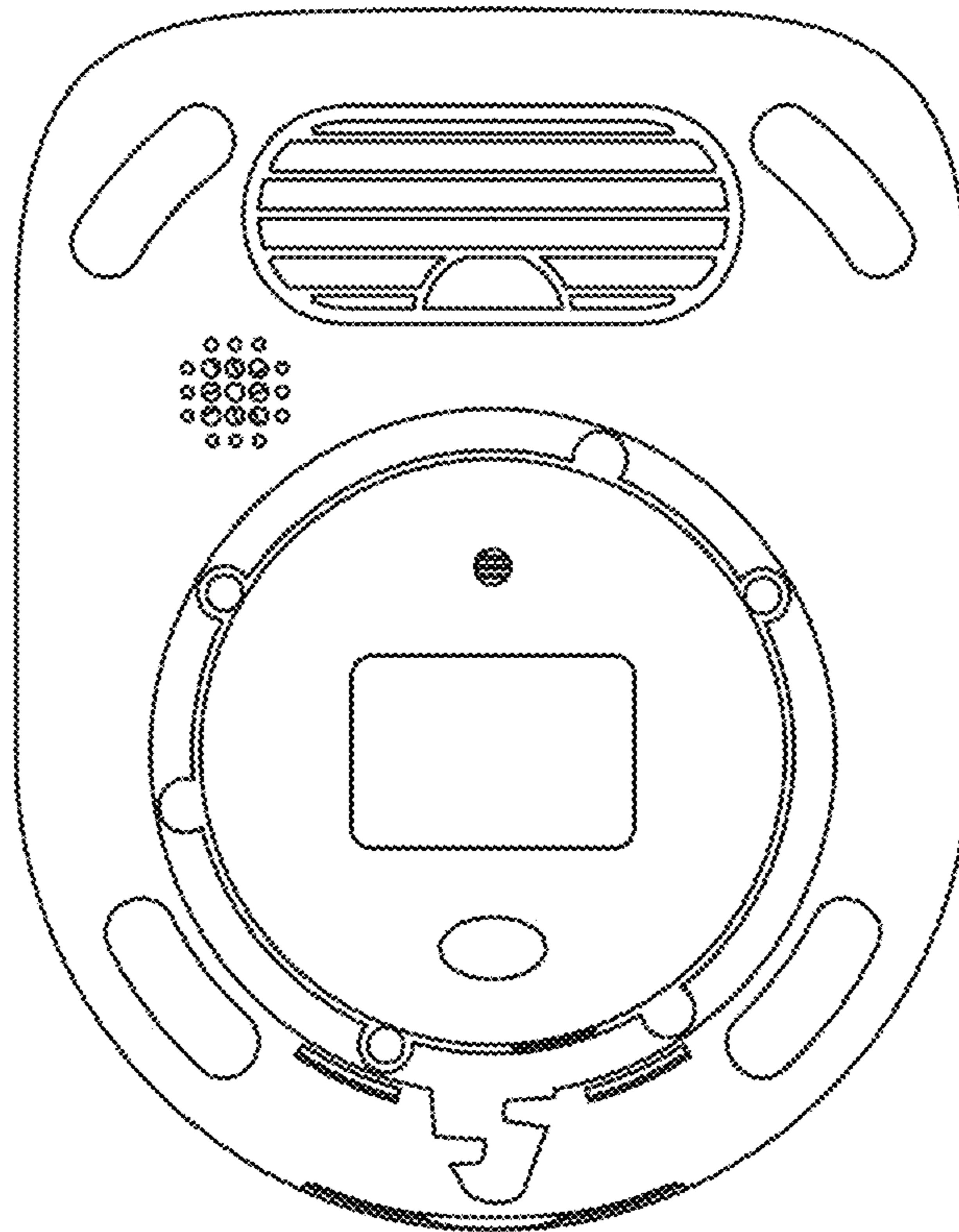

FIG. 7

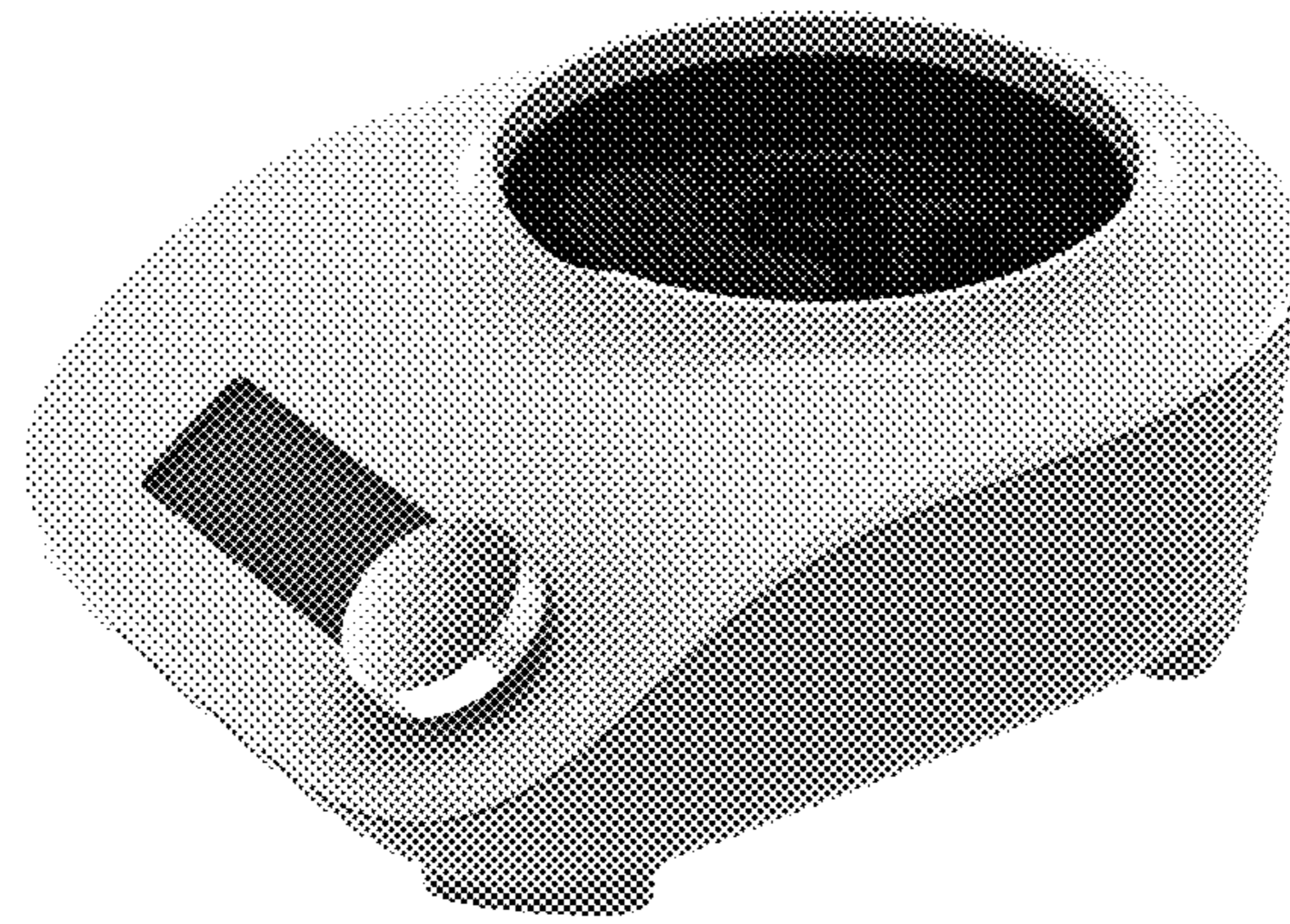

FIG. 8

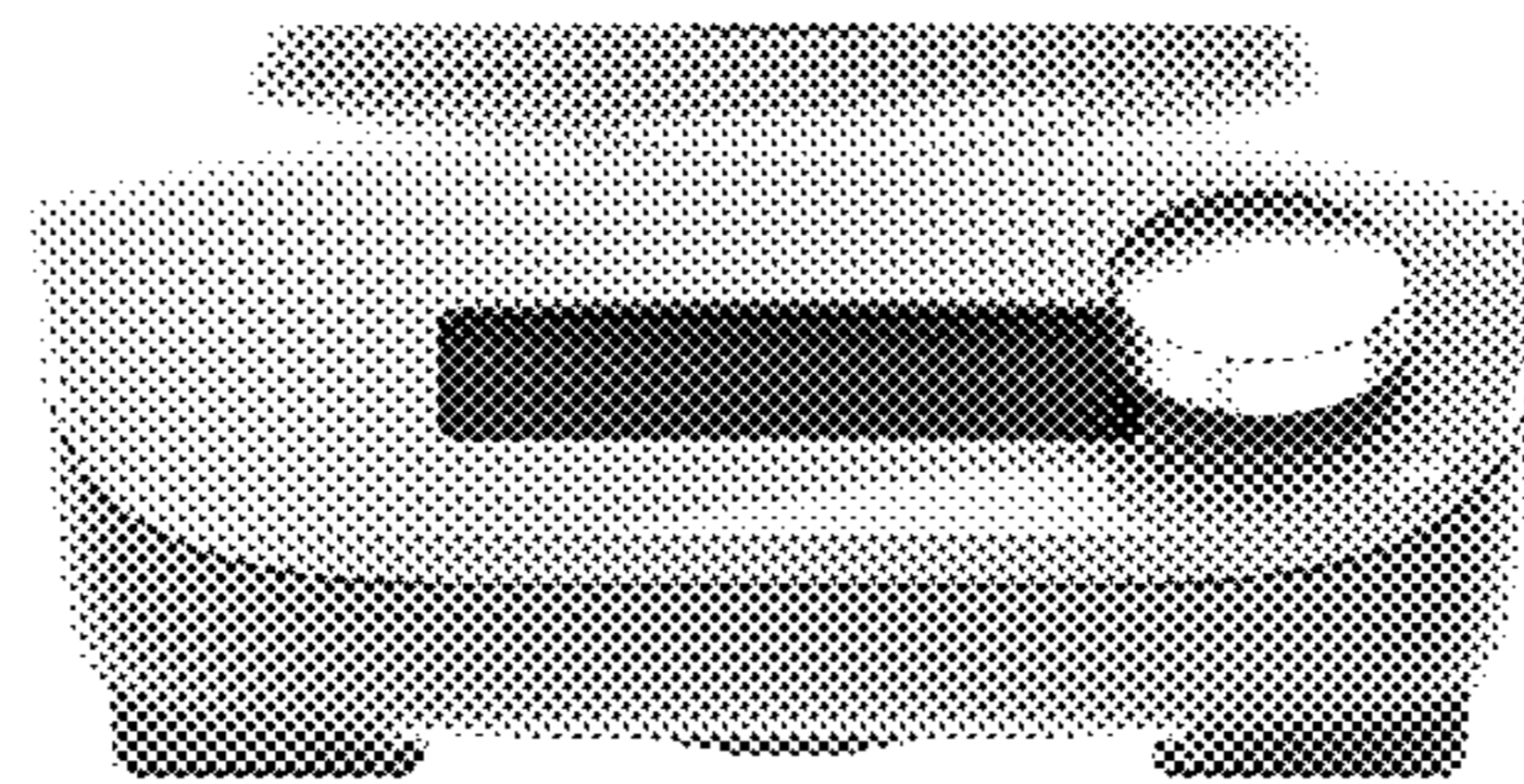

FIG. 9

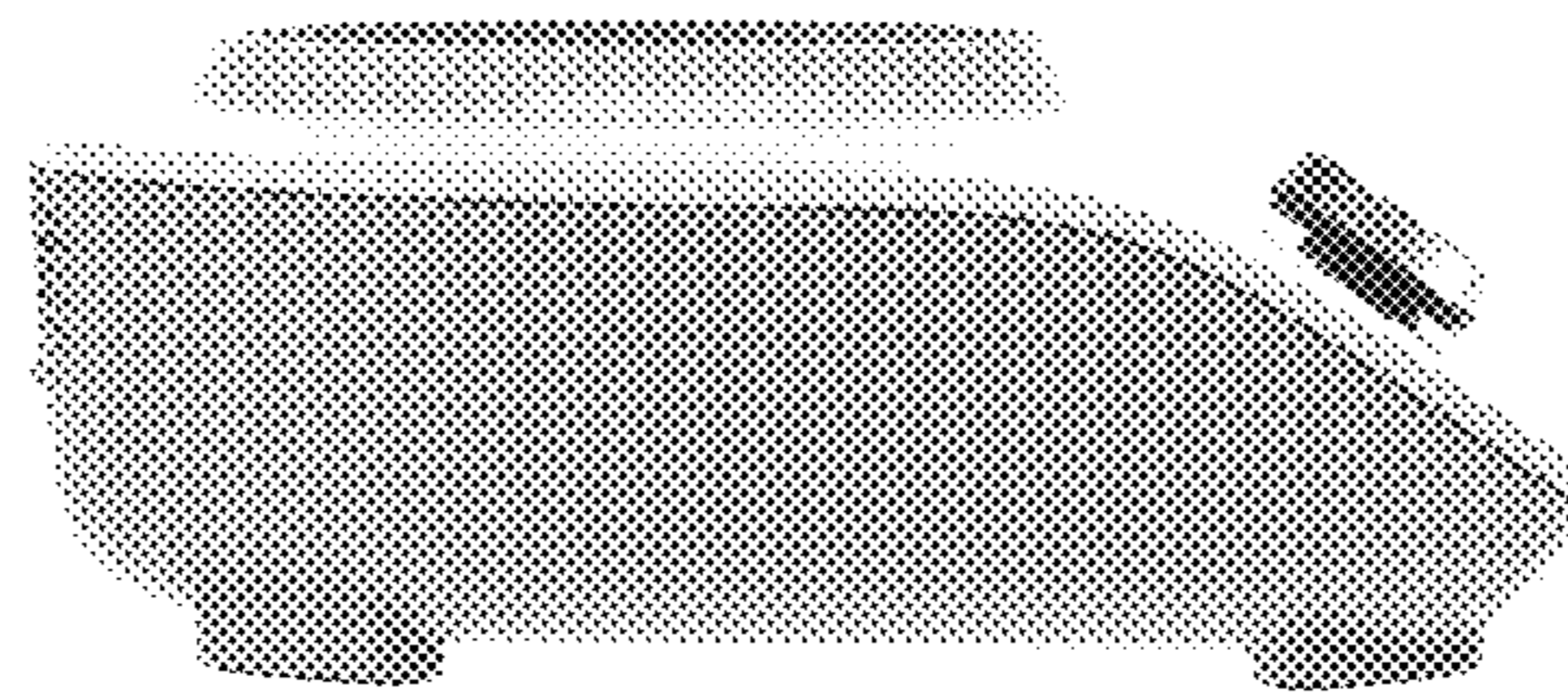

FIG. 10

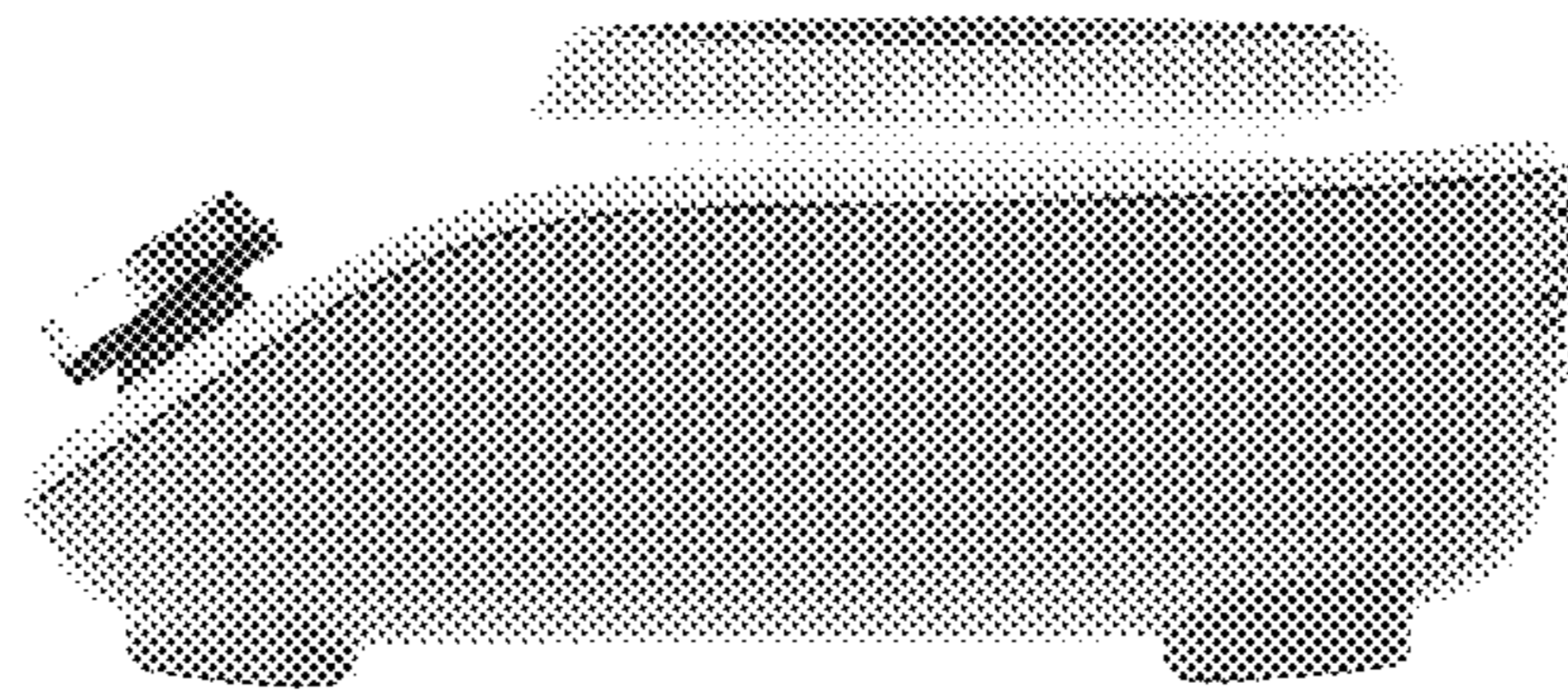

FIG. 11

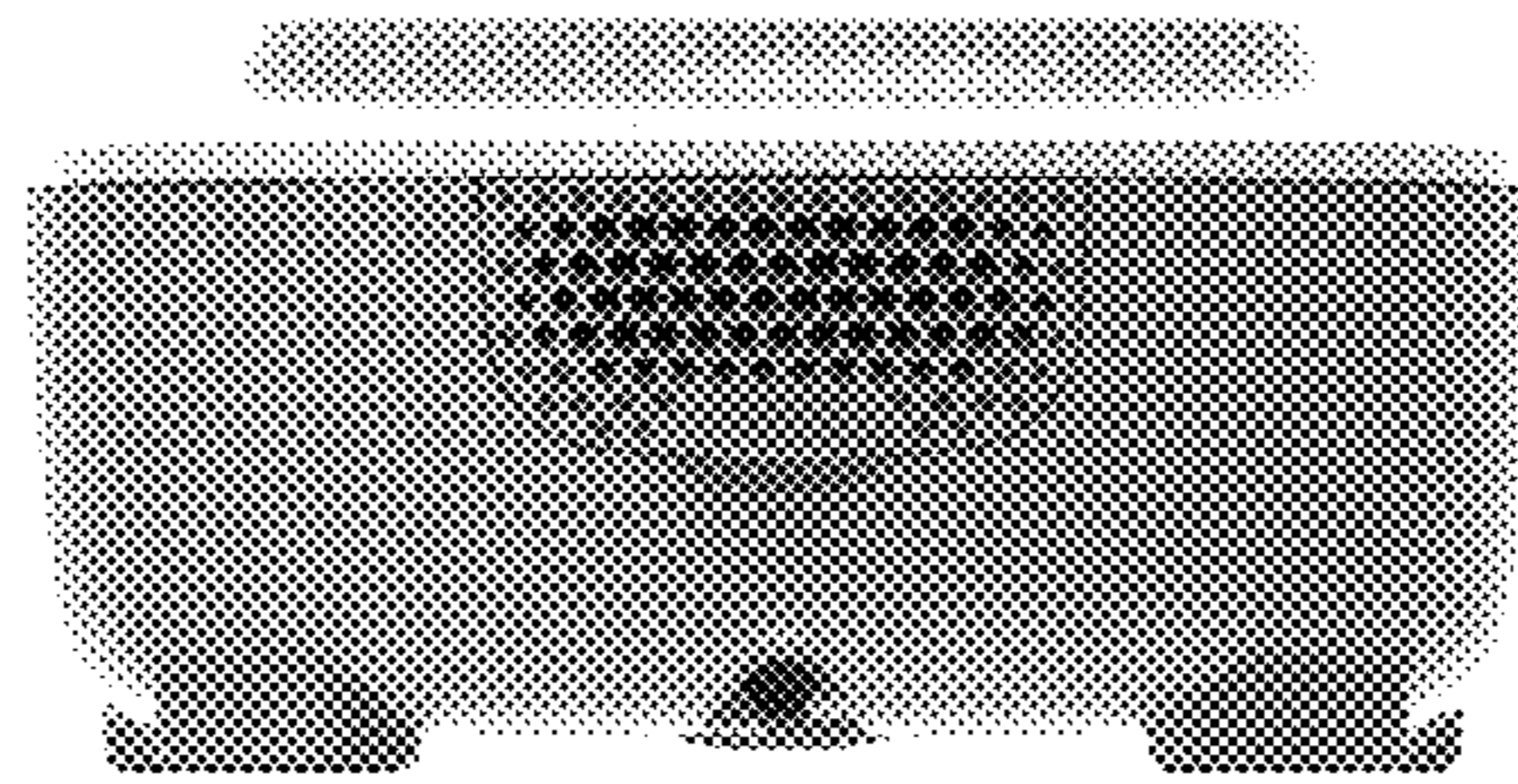

FIG. 12



FIG. 13



FIG. 14



FIG. 15

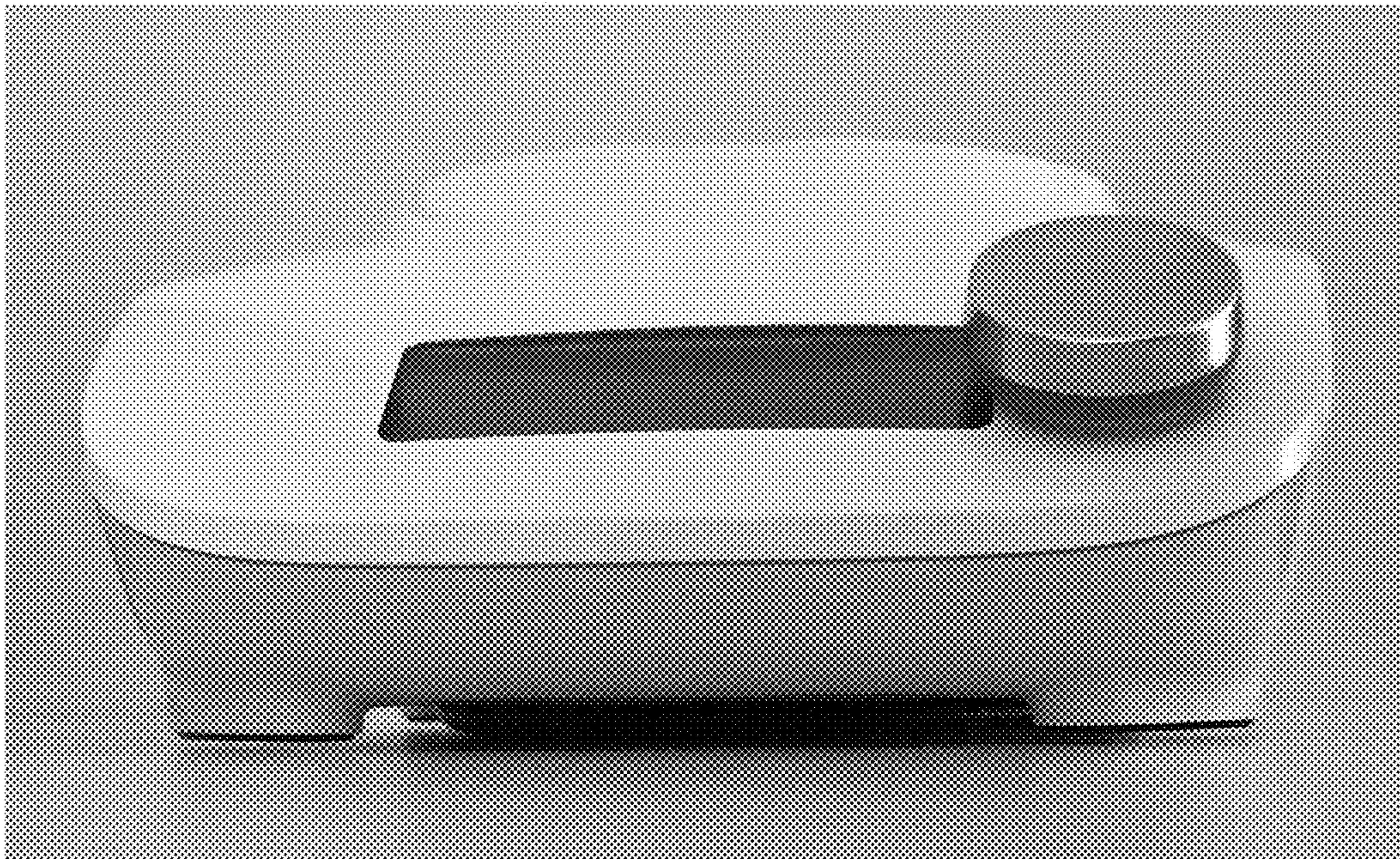

FIG. 16

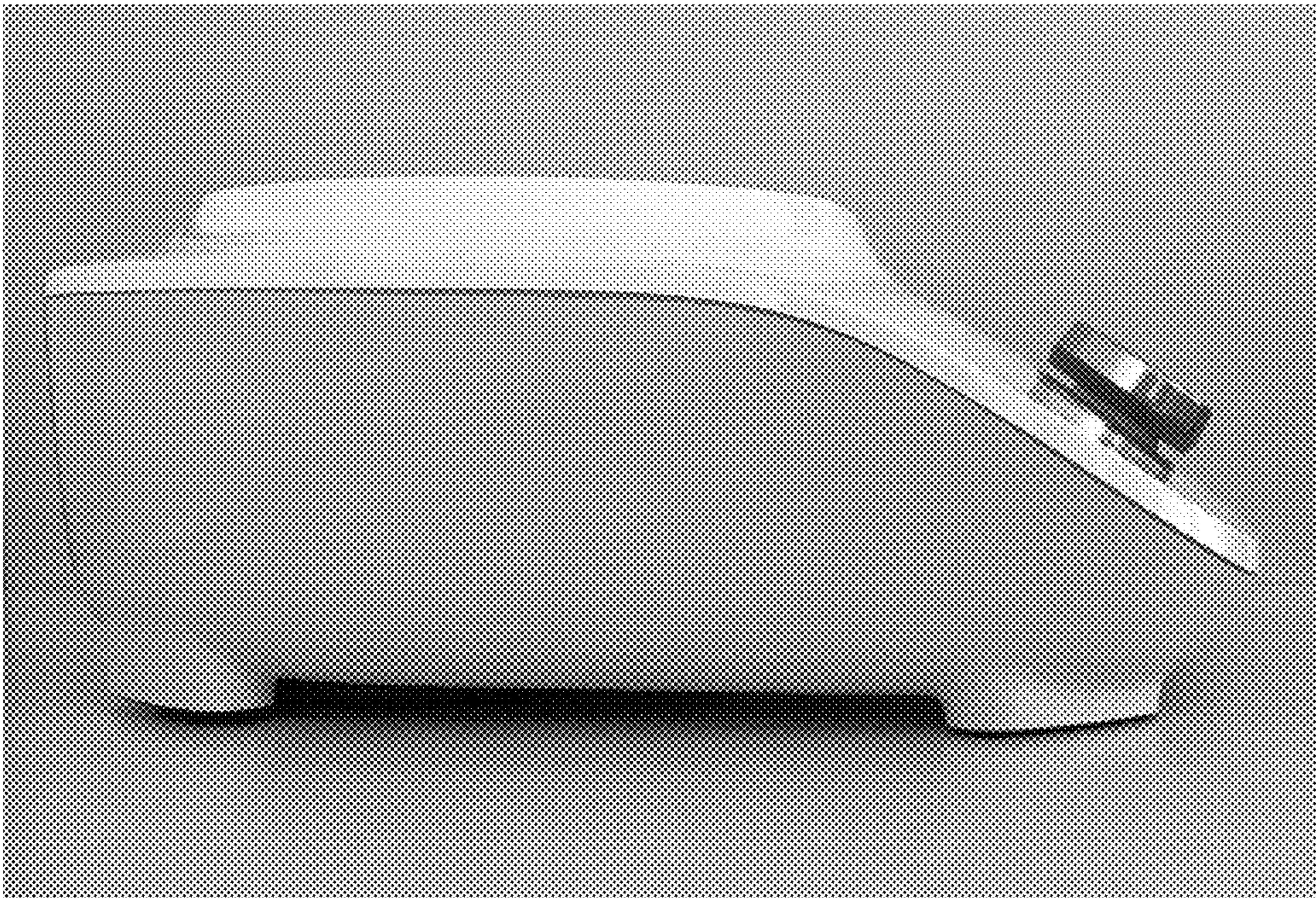

FIG. 17

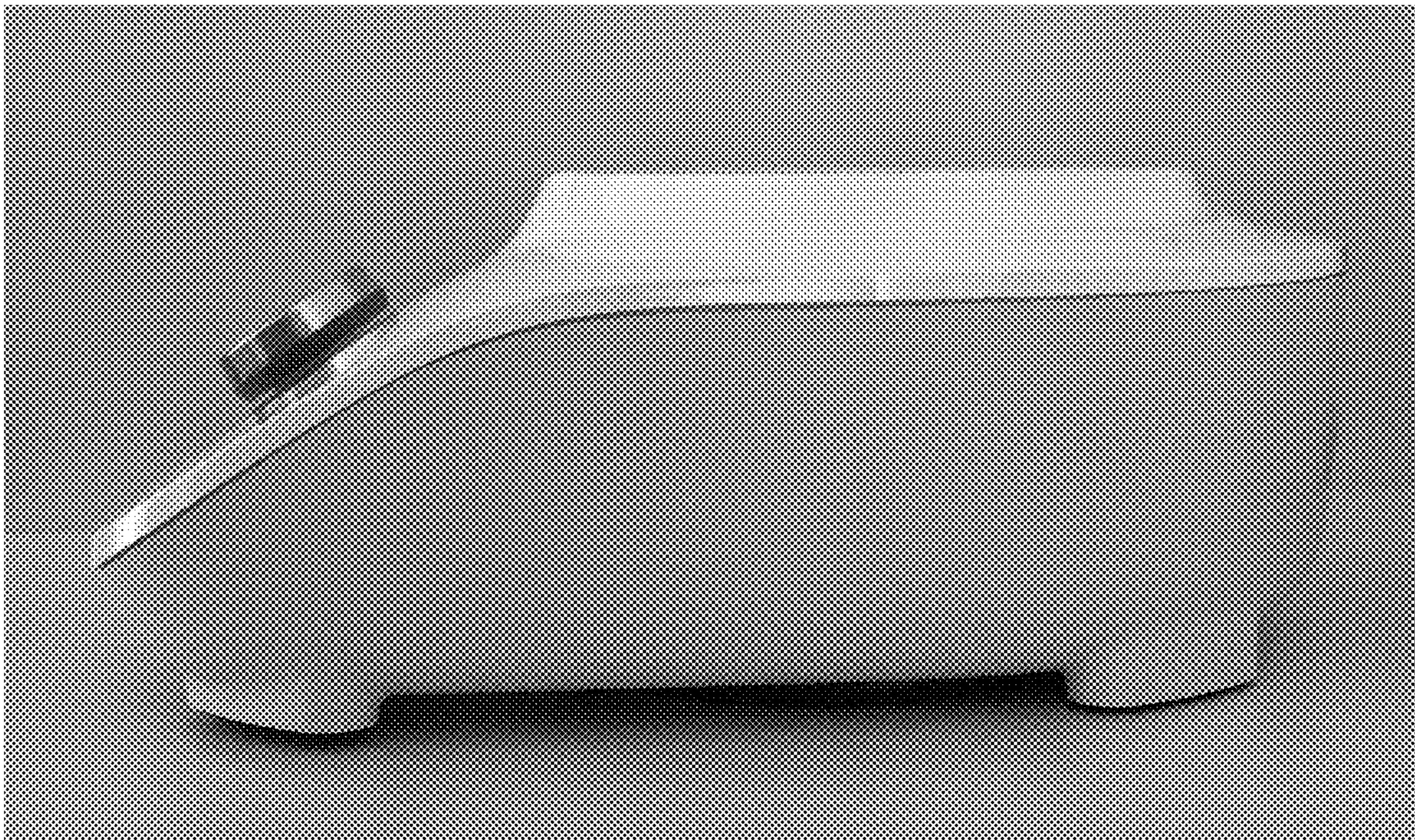

FIG. 18



FIG. 19



FIG. 20



FIG. 21