



US00D952396S

(12) **United States Design Patent**  
**Zhang**

(10) **Patent No.:** **US D952,396 S**

(45) **Date of Patent:** **\*\* May 24, 2022**

- (54) **PAN**
- (71) Applicant: **Siduo Zhang**, Guangdong (CN)
- (72) Inventor: **Siduo Zhang**, Guangdong (CN)
- (73) Assignee: **GUANGZHOU BAOMEI NETWORK TECHNOLOGY CO., LTD.**, Guangzhou (CN)
- (\*\*) Term: **15 Years**
- (21) Appl. No.: **29/794,943**
- (22) Filed: **Jun. 16, 2021**
- (51) **LOC (13) Cl.** ..... **07-02**
- (52) **U.S. Cl.**  
USPC ..... **D7/361; D7/354; D7/360**
- (58) **Field of Classification Search**  
USPC ..... D7/323, 354–363, 391, 393–396, 409, D7/533; D21/525  
CPC ..... A47G 19/12; A47J 27/00; A47J 27/002; A47J 27/08; A47J 27/21; A47J 27/58; A47J 27/122; A47J 36/022; A47J 36/025; A47J 36/06; A47J 36/12; A47J 37/00; A47J 37/10; A47J 37/101; A47J 37/103; A47J 37/12; A47J 37/1204; A47J 45/061; A47J 45/062; A47J 45/071; A47J 45/08; H05B 6/12  
See application file for complete search history.

- D537,672 S \* 3/2007 Hoenstein ..... D7/361
- D551,023 S \* 9/2007 Natalino ..... D7/533
- D579,716 S \* 11/2008 Pawson ..... D7/361
- D587,062 S \* 2/2009 Ek ..... D7/354
- D603,211 S \* 11/2009 Ek ..... D7/354
- D677,519 S \* 3/2013 Montgomery ..... D7/361
- D797,494 S 9/2017 Mirchandani et al.
- D876,152 S 2/2020 Levy

\* cited by examiner

*Primary Examiner* — Ricky Pham

(57) **CLAIM**

The ornamental design for a pan, as shown and described.

**DESCRIPTION**

FIG. 1 is a top, rear, left side perspective view of a pan showing my new design;  
 FIG. 2 is a bottom, front, right side perspective view thereof;  
 FIG. 3 is an enlarged front elevation view thereof;  
 FIG. 4 is an enlarged rear elevation view thereof;  
 FIG. 5 is an enlarged right side elevation view thereof, the left side elevation view being a mirror image of the right side elevation view;  
 FIG. 6 is an enlarged top plan view thereof; and,  
 FIG. 7 is an enlarged bottom plan view thereof.  
 The broken lines in the drawings illustrate portions of the pan that form no part of the claimed design.

**1 Claim, 7 Drawing Sheets**

- (56) **References Cited**  
U.S. PATENT DOCUMENTS  
D299,837 S \* 2/1989 McElhane ..... D21/525  
D453,092 S \* 1/2002 Coudurier ..... D7/361

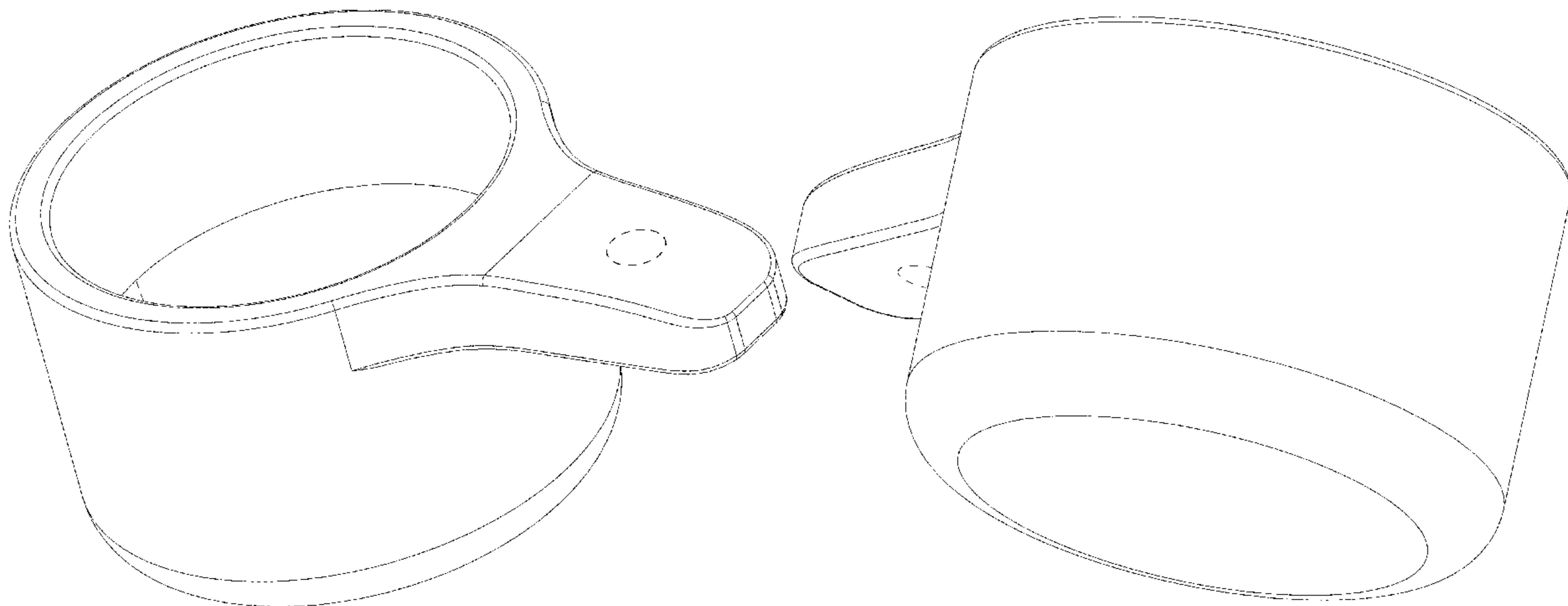

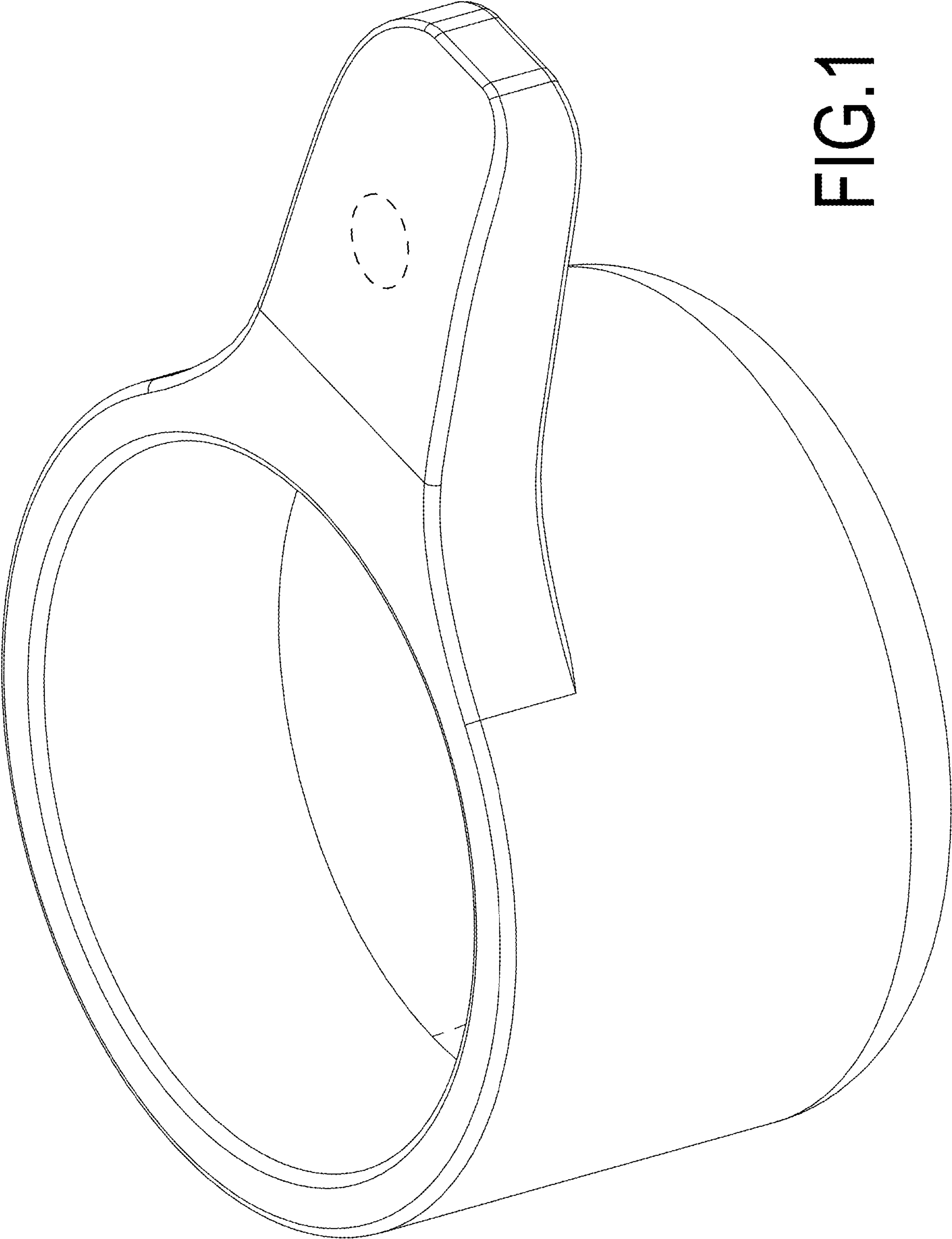

FIG. 1

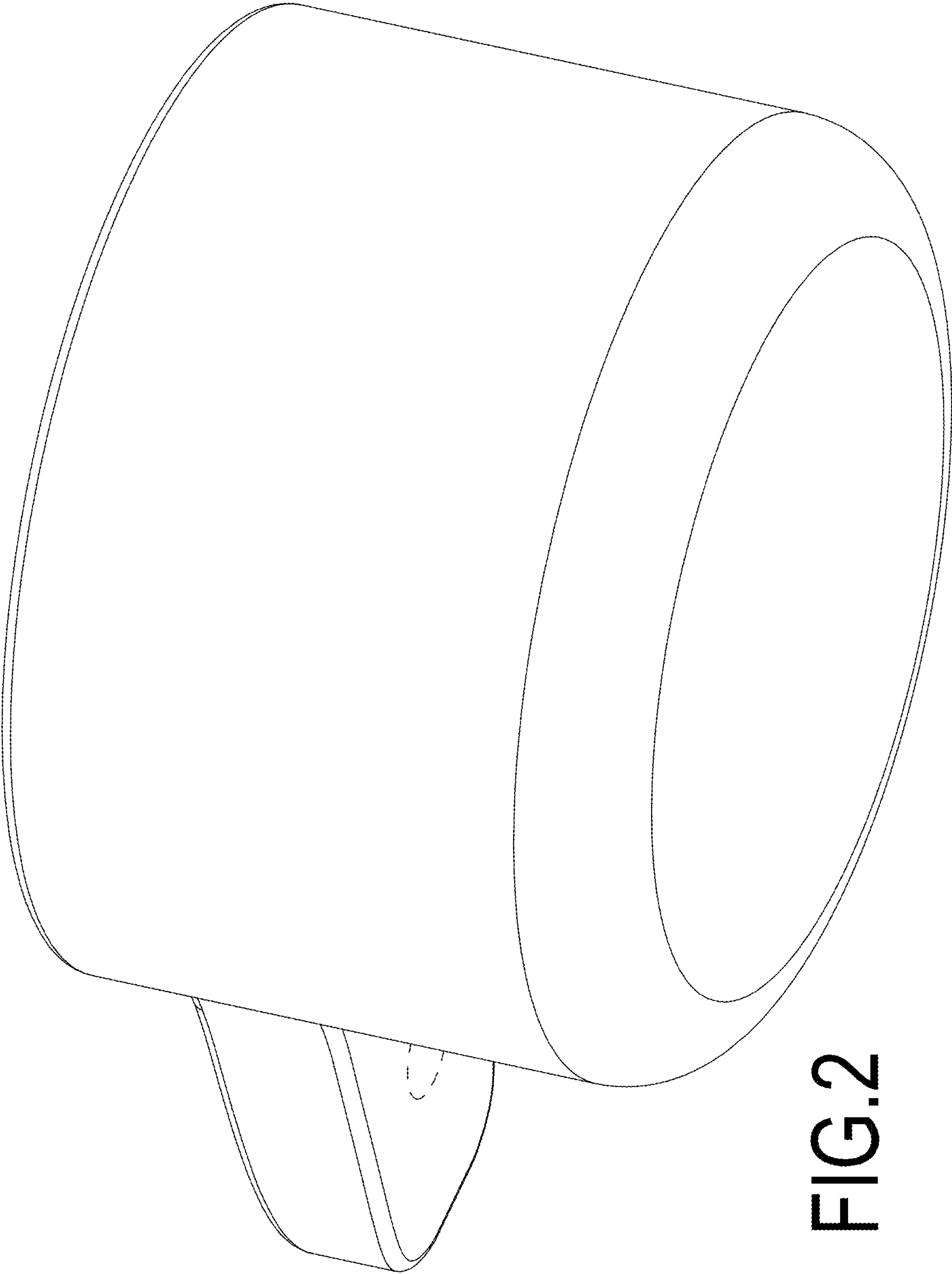

FIG. 2

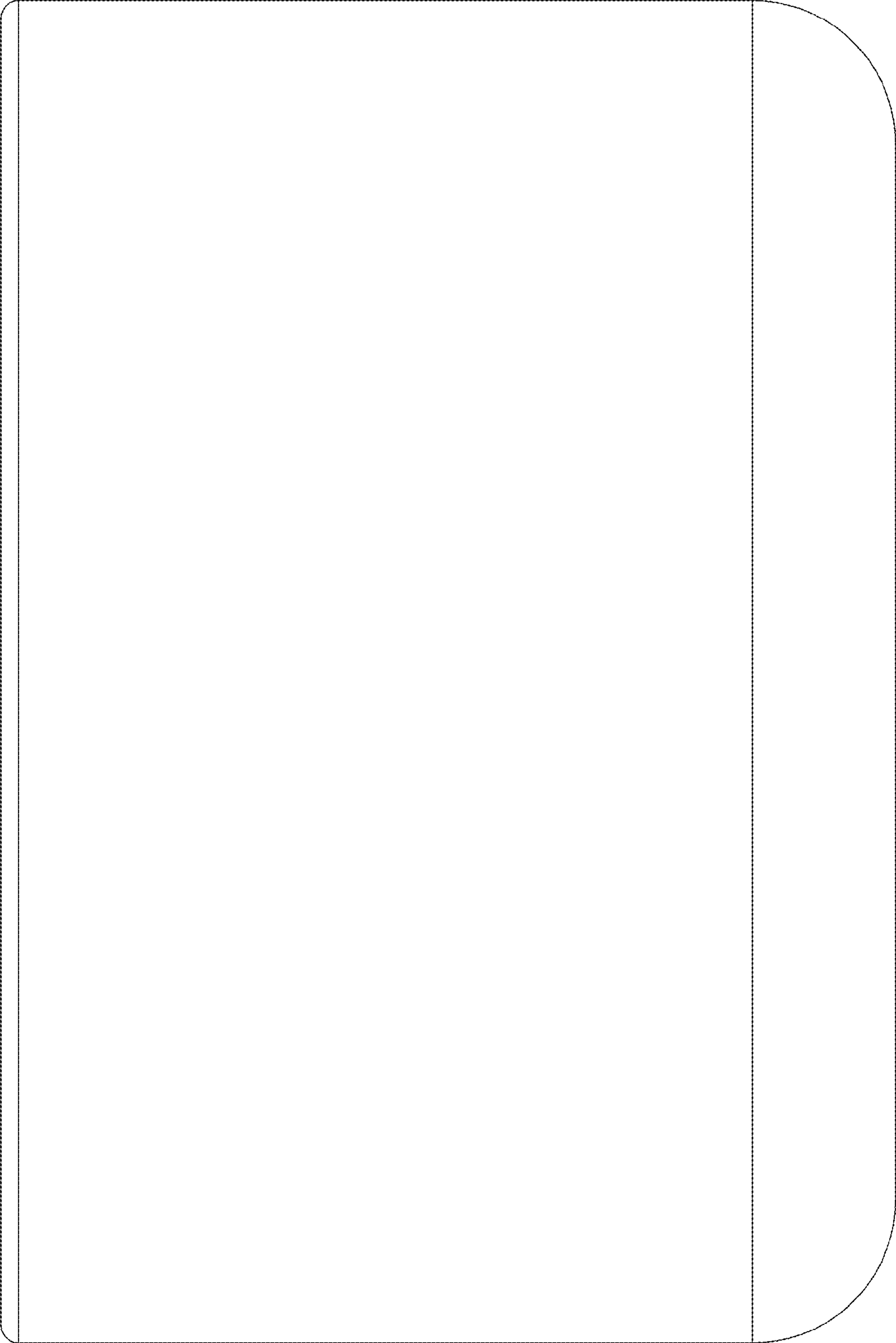

FIG.3

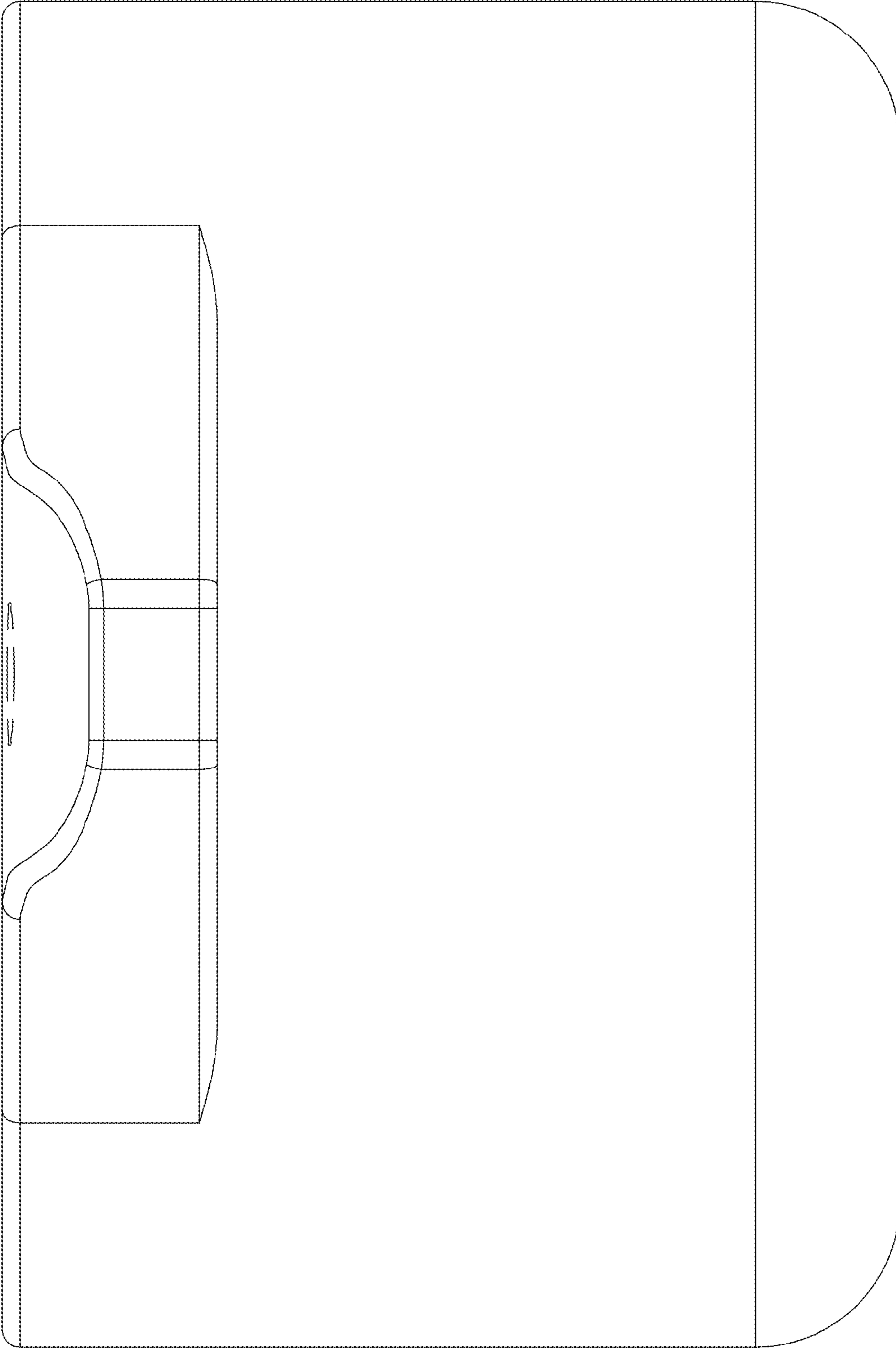

FIG.4

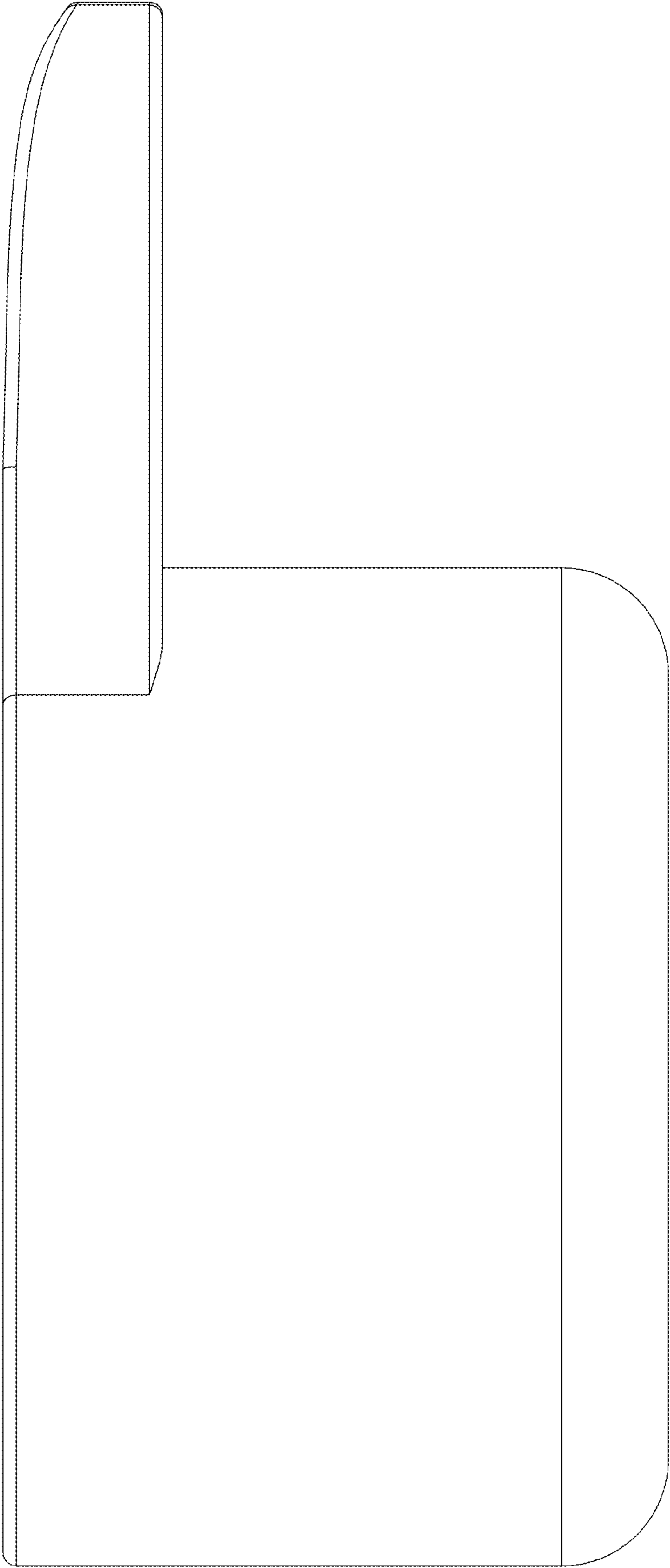

FIG. 5

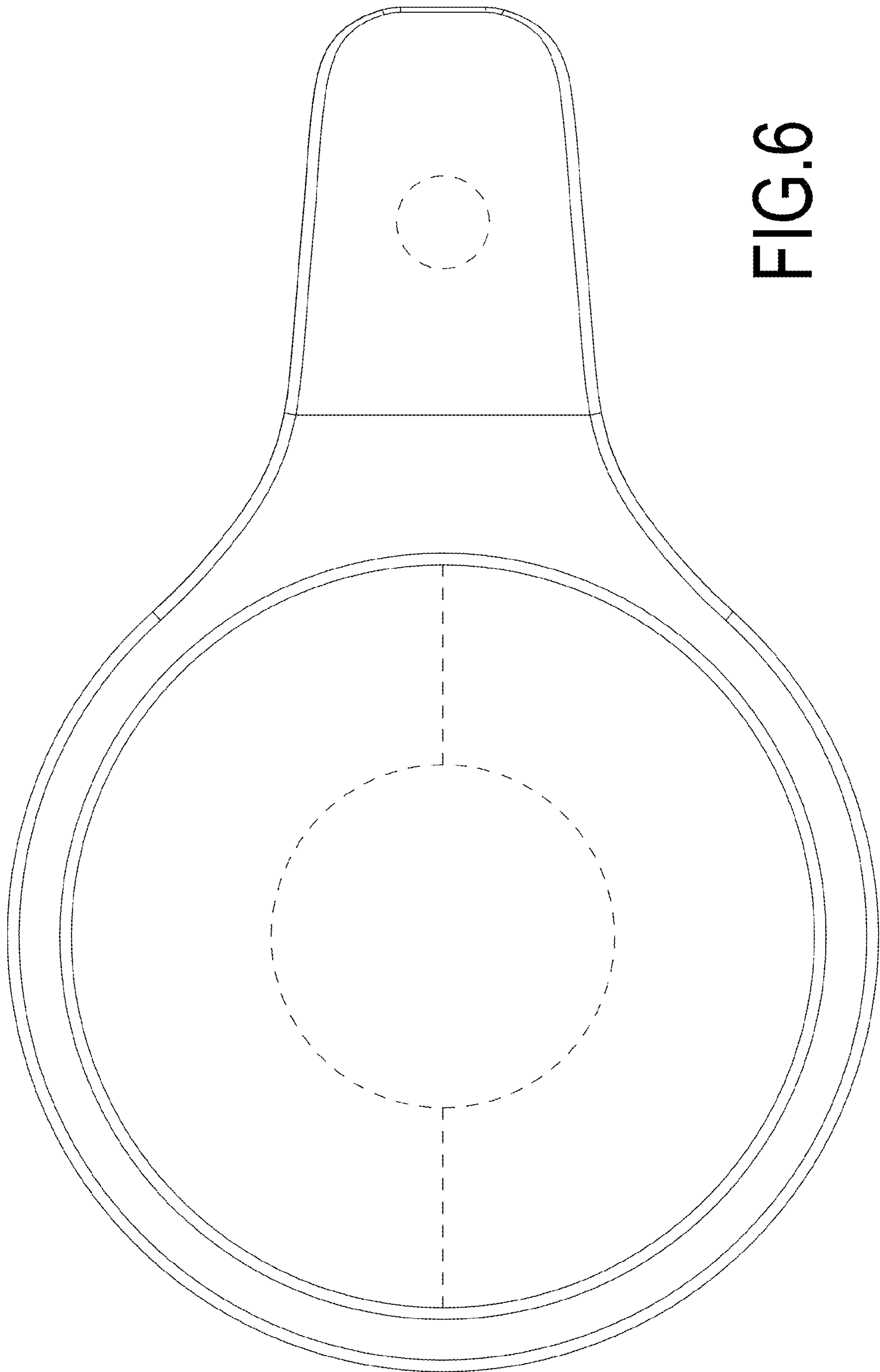

FIG. 6



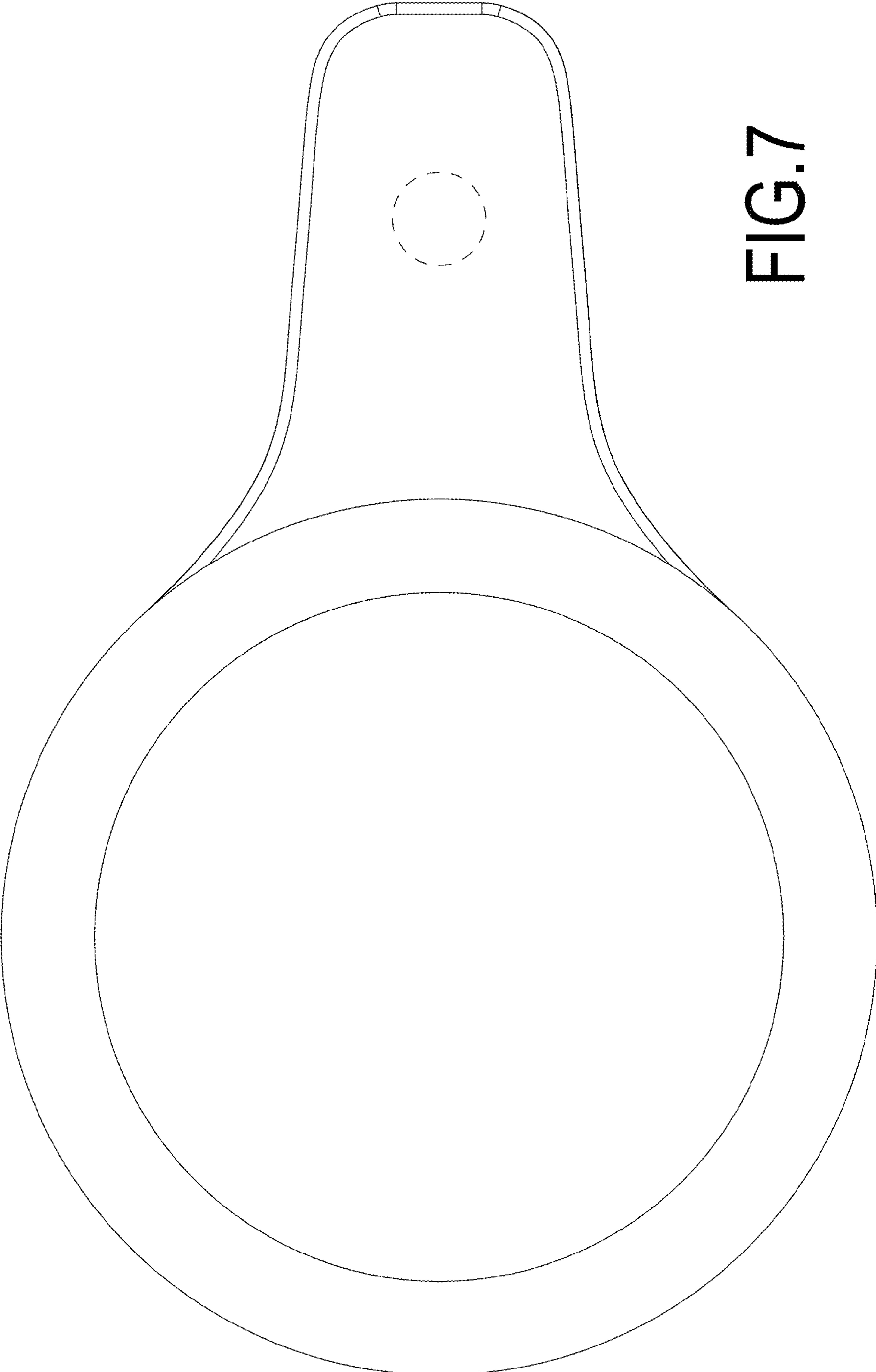

FIG.7