



US00D952376S

(12) **United States Design Patent** (10) **Patent No.:** **US D952,376 S**  
**Hu** (45) **Date of Patent:** **\*\* May 24, 2022**

(54) **GAMING DESK WITH POLYGON TOP**  
(71) Applicant: **Yajun Hu**, El Dorado Hills, CA (US)  
(72) Inventor: **Yajun Hu**, El Dorado Hills, CA (US)  
(73) Assignees: **Yajun Hu**, El Dorado Hills, CA (US);  
**EUREKA LLC**, EL Dorado Hills, CA (US)  
(\*\*) Term: **15 Years**  
(21) Appl. No.: **29/740,370**  
(22) Filed: **Jul. 2, 2020**  
(51) **LOC (13) Cl.** ..... **06-03**  
(52) **U.S. Cl.**  
USPC ..... **D6/655**; D6/695; D6/649  
(58) **Field of Classification Search**  
USPC ..... D6/654.1, 654, 654.21, 655, 654.18,  
D6/654.11, 654.14, 654.16, 654.17,  
D6/654.23, 655.11, 655.1, 655.14, 655.17,  
D6/655.18, 655.21, 655.23, 656, 656.1,  
D6/656.12, 656.13, 656.16, 656.17,  
D6/656.19, 648.2, 648.3, 648.4, 652.2,  
D6/651.1, 651.2, 652.1, 653, 653.1,  
D6/653.11, 653.14, 653.16, 653.17,  
D6/653.18, 653.21, 653.23, 641, 642,  
D6/648, 691, 691.3, 691.9, 686, 691.5  
CPC .... A47B 2200/0062; A47B 2200/0054; A47B  
2021/066; A47B 2200/0029; A47B  
2200/0051; A47B 2200/52; A47B  
2200/0059; A47B 2200/006; A47B  
2200/0061; A47B 9/00; A47B 13/10;  
A47B 21/00; A47B 21/0314; A47B 3/00;  
A47B 3/002; A47B 7/00; A47B 9/06;  
A47B 9/16; A47B 2009/065; A47B  
13/00; A47B 13/02; A47B 13/04; A47B  
13/06; A47B 13/08; A47B 13/12; A47B  
17/00; A47B 21/02; A47B 2200/0001;  
A47B 2200/0011; A47B 2200/002; A47B  
2200/0035; A47B 2200/0037; A47B  
2200/004; A47B 2200/0066

See application file for complete search history.

(56) **References Cited**  
U.S. PATENT DOCUMENTS  
4,632,349 A \* 12/1986 Anstey ..... A47B 21/0314  
108/105  
5,437,235 A \* 8/1995 Randolph ..... A47B 21/00  
108/25  
D478,225 S 8/2003 Wang  
(Continued)

**OTHER PUBLICATIONS**  
Height Adjustable Standing Desk Riser by Versa Desk, first avail-  
able: Aug. 28, 2018. Amazon.com [online], [site visited Nov. 15,  
2021], Internet URL: [https://www.amazon.com/VersaDesk-Power-Pro-Corner-Height-Adjustable/dp/B07GY3N5JD/ref=sr\\_1\\_69?th=1](https://www.amazon.com/VersaDesk-Power-Pro-Corner-Height-Adjustable/dp/B07GY3N5JD/ref=sr_1_69?th=1) (Year: 2018).\*

(Continued)

*Primary Examiner* — Steven J Czyz  
*Assistant Examiner* — Hillary Catherine Shepard

(57) **CLAIM**  
I claim the ornamental design for a gaming desk with  
polygon top, as shown and described.

**DESCRIPTION**  
FIG. 1 is a perspective view of a gaming desk with polygon  
top, showing my new design;  
FIG. 2 is a front view thereof;  
FIG. 3 is a bottom view thereof;  
FIG. 4 is a top view thereof;  
FIG. 5 is a rear side view thereof;  
FIG. 6 is a left side view thereof; and,  
FIG. 7 is a right side view thereof.  
The broken line portion of the figure drawings is included to  
show portions of the article that forms no part of the claimed  
design.

**1 Claim, 7 Drawing Sheets**

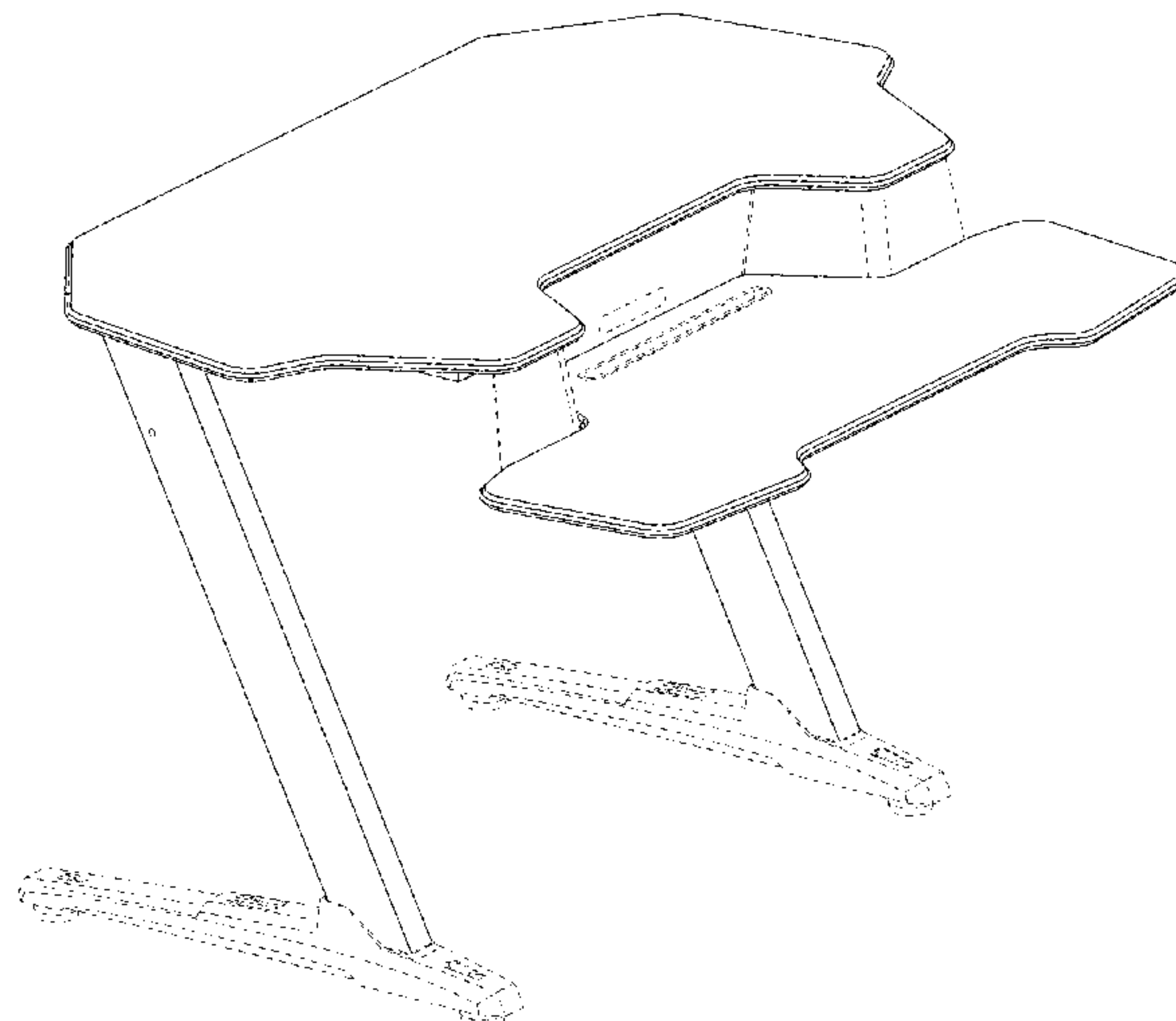

(56)

References Cited

U.S. PATENT DOCUMENTS

D499,273 S 12/2004 Chang  
 D499,576 S 12/2004 Long  
 D526,812 S 8/2006 Chen  
 D547,970 S 8/2007 Chou  
 D549,009 S 8/2007 Lin  
 D716,587 S \* 11/2014 Chang ..... D6/653.15  
 D730,668 S \* 6/2015 Fletcher ..... D6/707.22  
 9,049,923 B1 \* 6/2015 Delagey ..... A47B 9/18  
 D733,476 S \* 7/2015 Papic ..... D6/708  
 D743,718 S \* 11/2015 Tempas ..... D6/655.21  
 D771,981 S \* 11/2016 Flaherty ..... D6/655  
 9,504,316 B1 \* 11/2016 Streicher ..... A47B 21/02  
 D781,617 S \* 3/2017 Flaherty ..... D6/655  
 D781,618 S \* 3/2017 Flaherty ..... D6/655  
 9,591,919 B2 3/2017 Ergun et al.  
 D784,050 S \* 4/2017 Flaherty ..... D6/655  
 D785,989 S \* 5/2017 Flaherty ..... D6/696  
 9,635,932 B2 5/2017 Kelley et al.  
 9,717,327 B2 \* 8/2017 Papic ..... A47B 9/20  
 D814,214 S \* 4/2018 Flaherty ..... D6/648  
 9,961,991 B1 \* 5/2018 Chen ..... A47B 9/16  
 D830,739 S \* 10/2018 Min ..... D6/655  
 D832,623 S \* 11/2018 Flaherty ..... D6/655  
 D836,952 S \* 1/2019 Hu ..... D6/648  
 D837,574 S \* 1/2019 Hu ..... D6/655  
 D838,126 S \* 1/2019 Hu ..... D6/655.21  
 D841,369 S \* 2/2019 Hu ..... D6/655  
 D843,137 S \* 3/2019 Hu ..... D6/655  
 D845,037 S \* 4/2019 Min ..... D6/655  
 D845,678 S \* 4/2019 Laudadio ..... D6/649  
 D852,548 S \* 7/2019 Hu ..... D6/655  
 D859,044 S \* 9/2019 Ferentinos ..... D6/708.16  
 D862,128 S \* 10/2019 Hu ..... D6/656.11  
 D865,404 S \* 11/2019 Hu ..... D6/655.13  
 D867,042 S \* 11/2019 Hu ..... D6/708  
 D870,490 S \* 12/2019 Hu ..... D6/655  
 D870,491 S \* 12/2019 Hu ..... D6/655.2  
 10,517,390 B2 \* 12/2019 Xiang ..... A47B 9/10  
 D875,441 S \* 2/2020 Duan ..... D6/655.18  
 D878,813 S \* 3/2020 Knapp ..... D6/655  
 D878,815 S \* 3/2020 Peng ..... D6/656  
 D882,986 S \* 5/2020 Knapp ..... D6/655  
 D885,087 S \* 5/2020 Knapp ..... D6/655  
 D885,088 S \* 5/2020 Knapp ..... D6/655  
 D885,089 S \* 5/2020 Knapp ..... D6/655.2

D887,181 S \* 6/2020 Hu ..... D6/655.2  
 D887,182 S \* 6/2020 Walker ..... D6/655.21  
 D889,169 S \* 7/2020 Hu ..... D6/656.16  
 D893,919 S \* 8/2020 Hu ..... D6/656.11  
 D893,920 S \* 8/2020 Hu ..... D6/656.16  
 D894,639 S \* 9/2020 Hu ..... D6/656.11  
 D894,640 S \* 9/2020 Hu ..... D6/656.16  
 D901,959 S \* 11/2020 Chang ..... D6/709  
 10,893,748 B1 \* 1/2021 Poniatowski ..... A47B 21/06  
 D911,075 S \* 2/2021 Hu ..... D6/656.16  
 D913,019 S \* 3/2021 Norwalk ..... D6/655  
 D916,532 S \* 4/2021 Chen ..... D6/656.16  
 D923,989 S \* 7/2021 Chang ..... D6/707  
 D925,950 S \* 7/2021 Zhou ..... D6/656.16  
 D926,499 S \* 8/2021 Zhou ..... D6/656.16  
 D927,228 S \* 8/2021 Hu ..... D6/656.16  
 D927,893 S \* 8/2021 Hoffman ..... D6/648  
 11,219,307 B2 \* 1/2022 Laudadio ..... A47B 21/06  
 D945,796 S \* 3/2022 Hu ..... D6/648.4  
 2017/0071332 A1 \* 3/2017 Herring ..... A47B 21/0314  
 2017/0290413 A1 \* 10/2017 Hu ..... A47B 9/02  
 2017/0360192 A1 \* 12/2017 Hu ..... A47B 9/16  
 2018/0279770 A1 \* 10/2018 Crowe ..... A47B 21/02  
 2019/0110588 A1 \* 4/2019 Wong ..... A47B 21/02  
 2019/0269237 A1 \* 9/2019 Zhu ..... A47B 9/16  
 2019/0328129 A1 \* 10/2019 Namala ..... A47B 9/16  
 2019/0374024 A1 \* 12/2019 Elliott ..... A47B 13/088  
 2020/0029685 A1 \* 1/2020 Du ..... A47B 21/02

OTHER PUBLICATIONS

L Shaped Gaming Desk by Ecoprso, first available: Jan. 6, 2021. Amazon.com [online], [site visited Nov. 15, 2021], Internet URL: <https://www.amazon.com/Ecoprsio-Computer-Keyboard-Workstation-Headphone/dp/B08S79WN1J?th=1> (Year: 2021).\*

Keyboard Tray Gaming Desk by Eureka Ergonomic, first available: Oct. 19, 2021. Amazon.com [online], [site visited Nov. 15, 2021], Internet URL: [https://www.amazon.com/EUREKA-ERGONOMIC-Keyboard-Computer-Workstation/dp/B09JSSQD7Z/ref=sr\\_1\\_5](https://www.amazon.com/EUREKA-ERGONOMIC-Keyboard-Computer-Workstation/dp/B09JSSQD7Z/ref=sr_1_5) (Year: 2021).\*

Z2-B by Eureka Ergonomic, first available: unknown. Eurekaergonomic.com [online], [site visited Nov. 15, 2021], Internet URL: <https://eurekaergonomic.com/z2-b/> (Year: 2021).\*

Z60 Gaming Desk by Eureka Ergonomic, first available: Feb. 4, 2019. Amazon.com [online], [site visited Nov. 15, 2021], Internet URL: [https://www.amazon.com/Eureka-Ergonomic-Gaming-Computer-Mousepad/dp/B07KQV6YML/ref=sr\\_1\\_1](https://www.amazon.com/Eureka-Ergonomic-Gaming-Computer-Mousepad/dp/B07KQV6YML/ref=sr_1_1) (Year: 2019).\*

\* cited by examiner

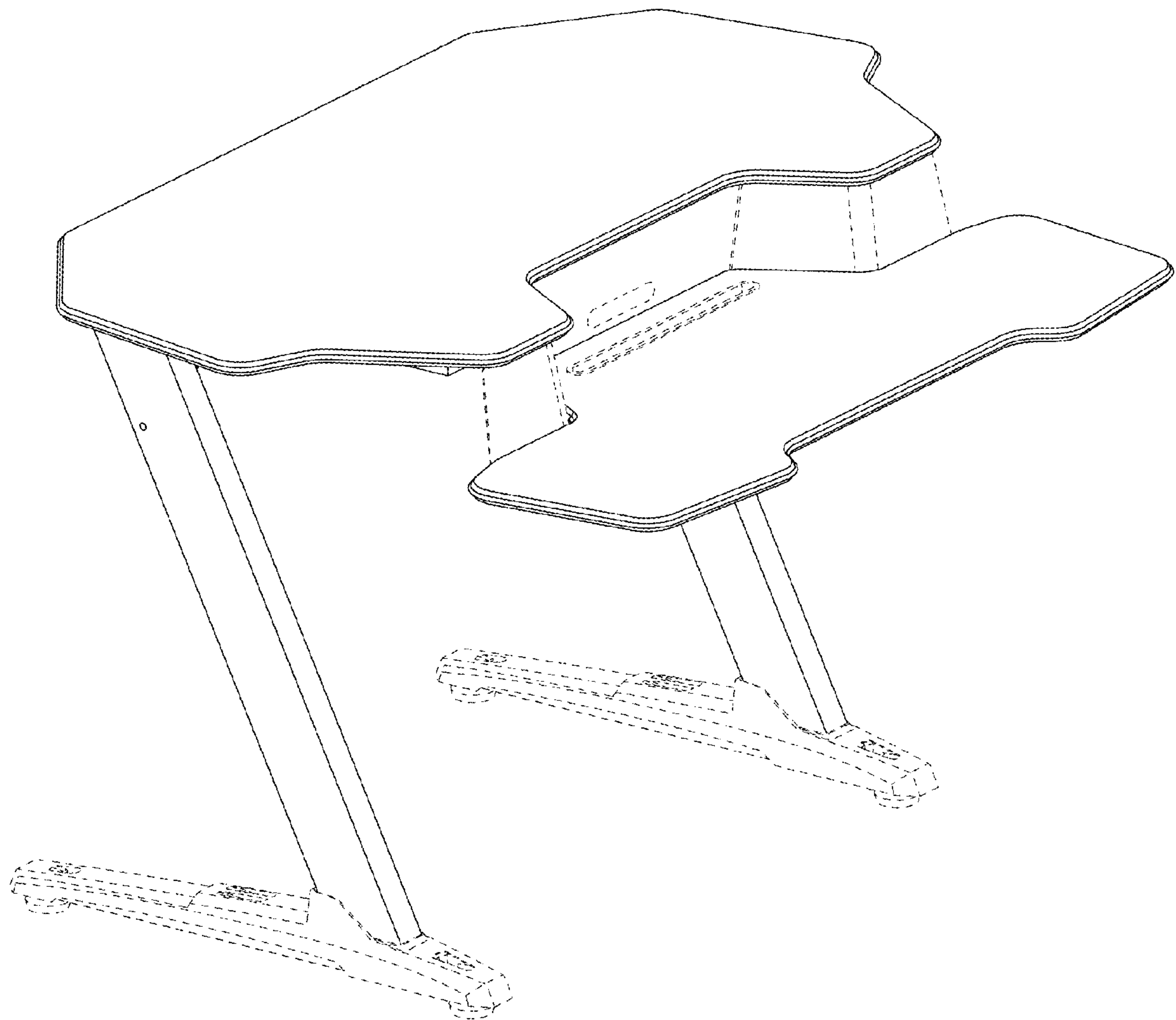

FIG.1



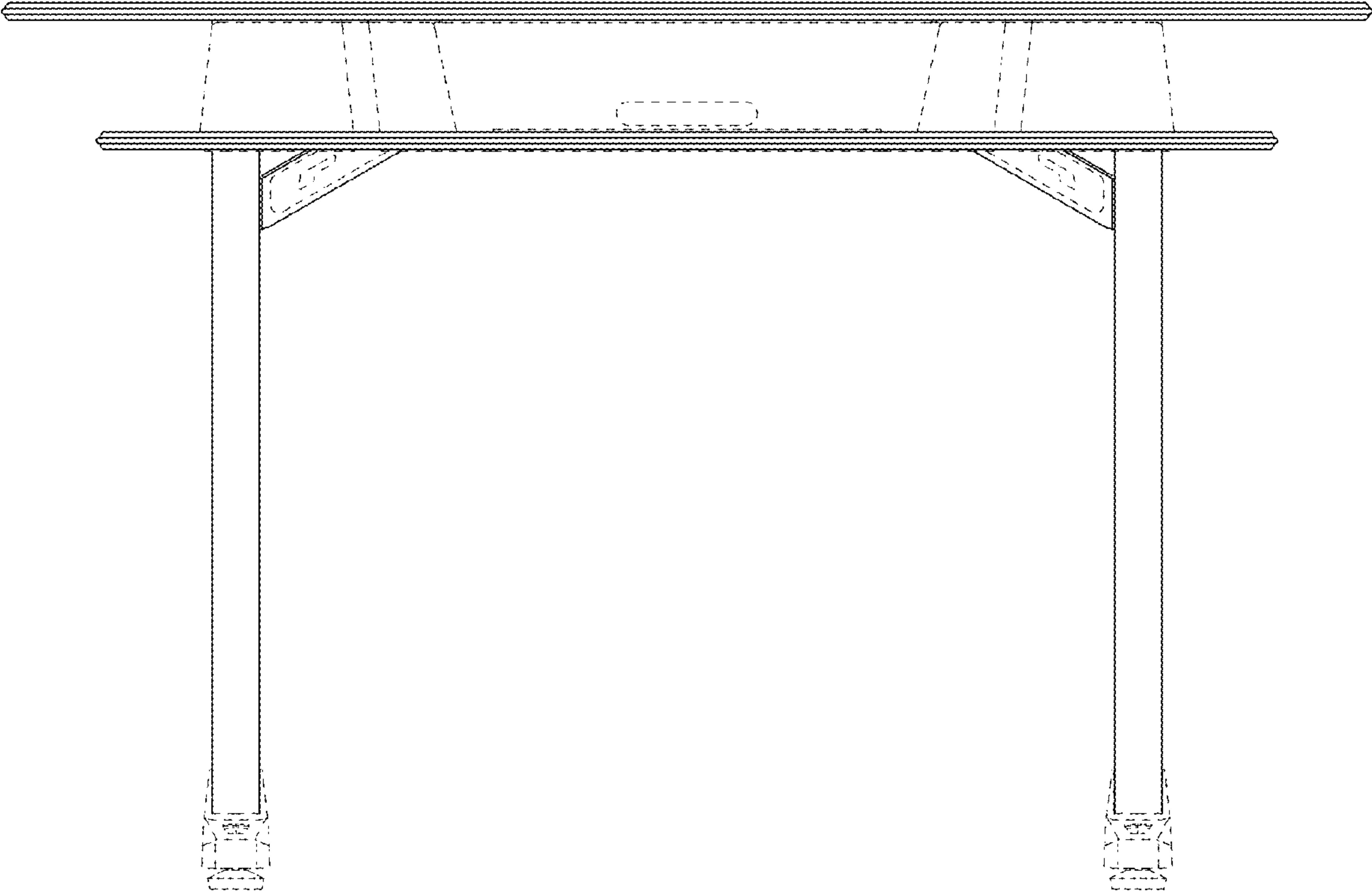

FIG.2

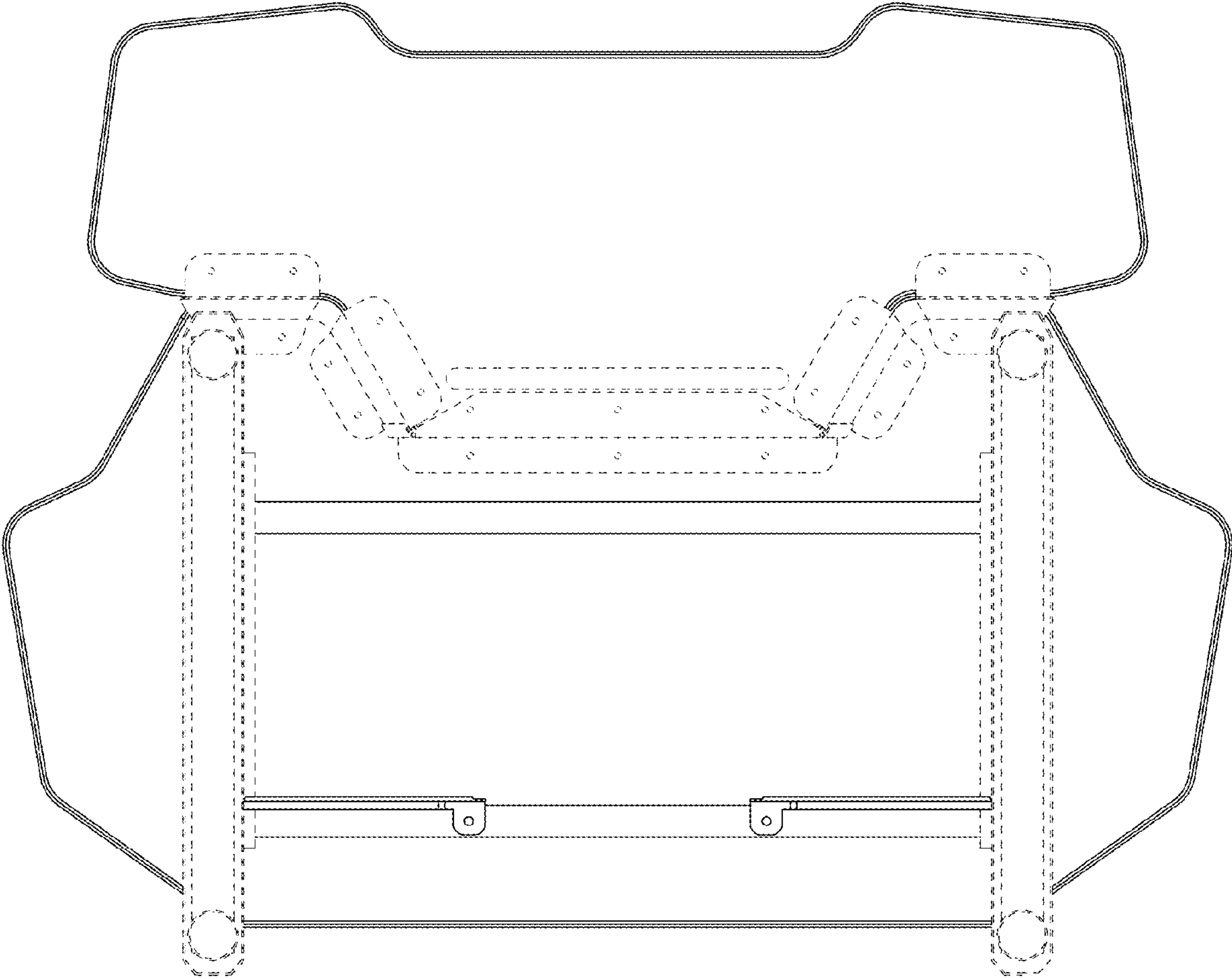

FIG.3

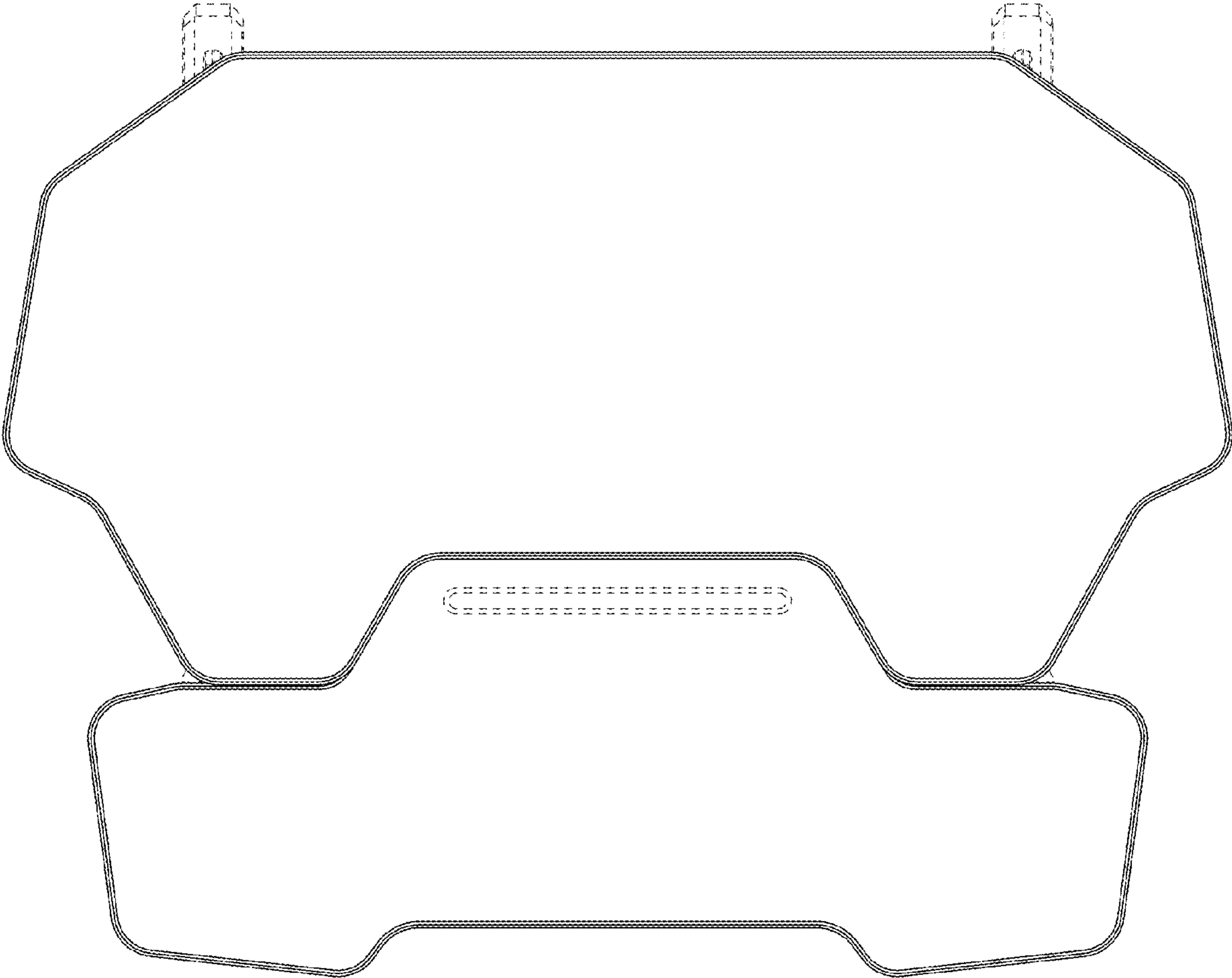

FIG.4

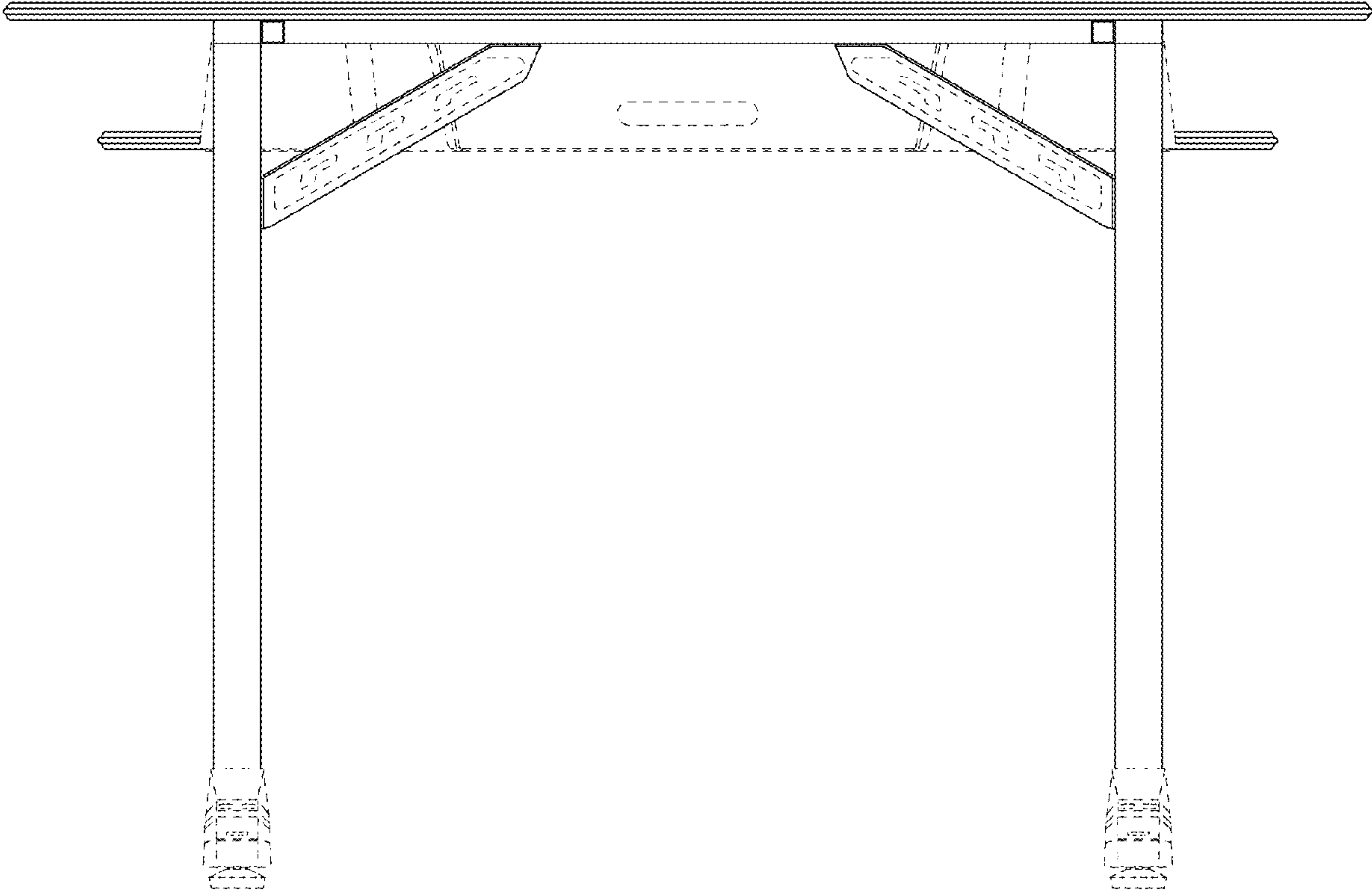

FIG.5

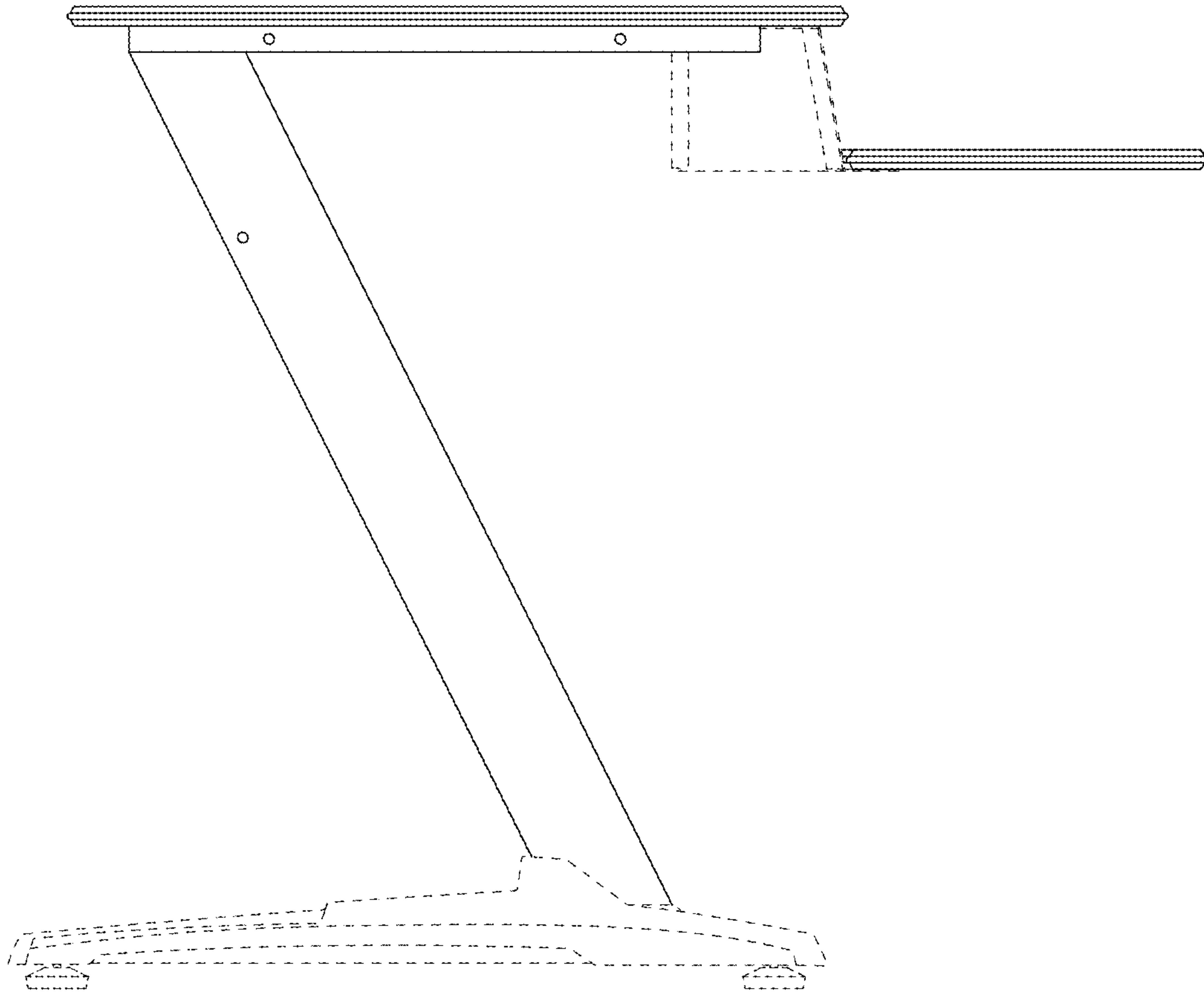

FIG.6



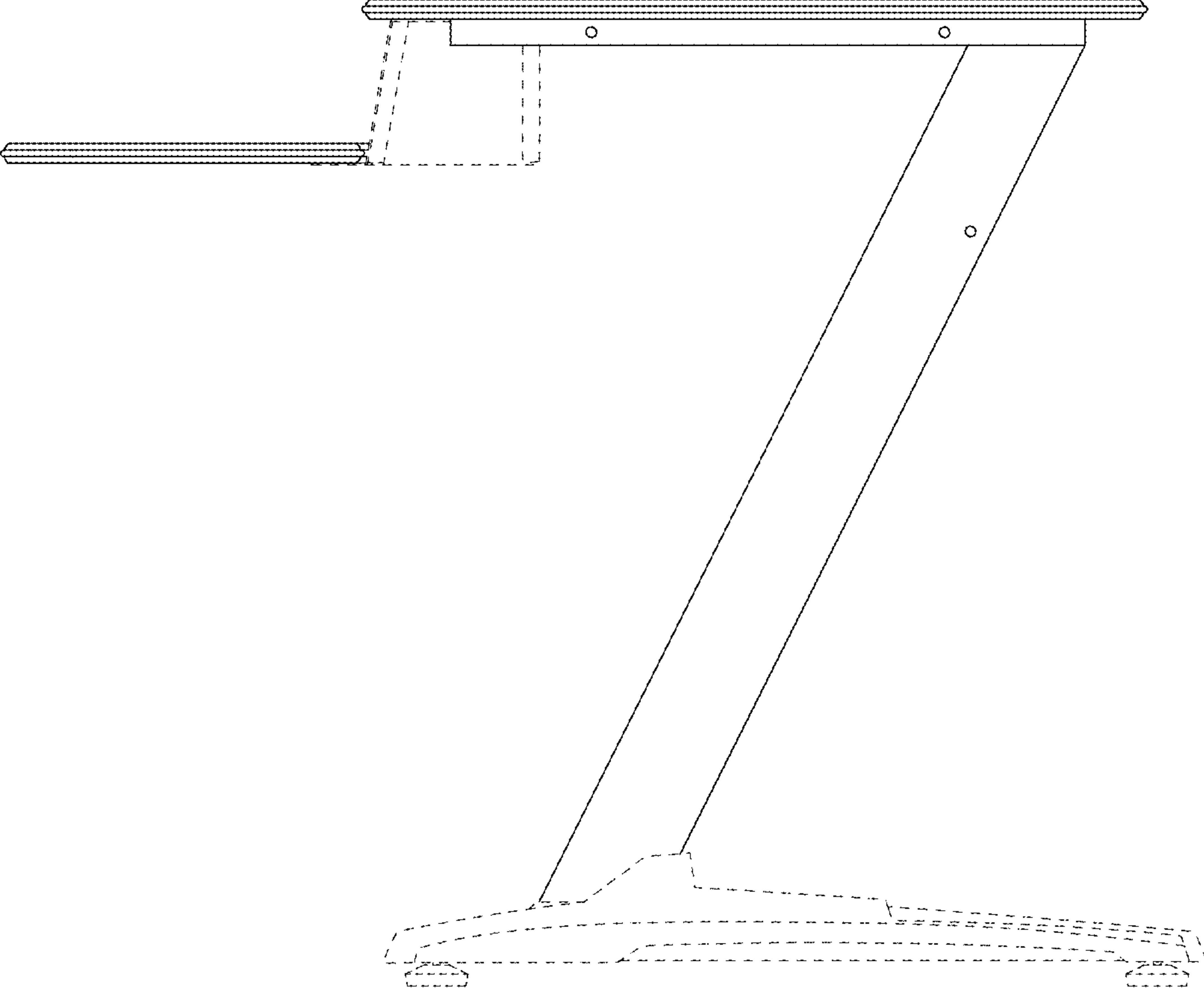

FIG.7