



US00D952267S

(12) **United States Design Patent**
Yi

(10) **Patent No.:** **US D952,267 S**

(45) **Date of Patent:** **** May 17, 2022**

(54) **PET TRAVEL CUP**

(71) Applicant: **SHENZHEN LESHUO TECHNOLOGY CO., LTD.**, Shenzhen (CN)

(72) Inventor: **Zhou Yi**, Shenzhen (CN)

(73) Assignee: **SHENZHEN LESHUO TECHNOLOGY CO., LTD.**, Shenzhen (CN)

(**) Term: **15 Years**

(21) Appl. No.: **29/746,659**

(22) Filed: **Aug. 15, 2020**

(51) **LOC (13) Cl.** **30-03**

(52) **U.S. Cl.**
USPC **D30/132**; D30/121; D30/129

(58) **Field of Classification Search**
USPC D30/121-133; 119/51.01, 61, 51.04, 53, 119/57.91, 54, 53.5, 52.4, 51.11, 63, 61.2, 119/52.1, 57.5, 57.6, 51.13, 62, 75, 500, 119/501, 72, 72.5, 74, 78-81, 61.56, 51.5; 239/7, 687, 379, 397.5; 222/199, 181.1, 222/181.2, 185.1, 557, 156, 485, 486, 222/548, 555, 207, 205, 424, 438, 48, 222/206, 212, 215, 460, 461, 525, 86, 89; 220/200, 227, 247, 262, 694, 700, 701, 220/703, 660-662, 521, 705, 709, 287, 220/523, 574, 6, 771, 737, 23.83, 212, 220/4.22, 847; 221/174, 185.1, 289, 295, 221/296, 559; 454/35; 209/270, 283, 209/244; 52/194, 192; 49/279, 344, 357; D34/28; D9/531, 549, 516, 523, 530, D9/538, 541, 544, 559, 719, 716, 424, D9/426, 432, 428, 431, 433, 739; D7/300, 300.1, 302-305, 312, 316, 317, D7/507-512, 523, 524, 528, 700, 709, D7/605, 620, 612, 619.1, 624.2, 624.3, D7/550.1, 571, 587; D3/132; D15/143,

D15/199; D28/4, 7, 9; D19/66; 141/343, 331, 340, 384, 330, 332, 383, 141/311 R, 313, 338, 344, 345; 210/455; 215/228, 231, 235, 319-383,386, DIG. 7, 215/388, 6, 12.1, 10, 13.1; 4/258, 259, 4/267; 206/459.1, 459.5, 501, 45.23, 6, (Continued)

(56) **References Cited**

U.S. PATENT DOCUMENTS

1,393,657 A * 10/1921 Altenberg A45C 11/20
206/544
1,744,328 A * 1/1930 Morley A47J 43/27
215/383

(Continued)

Primary Examiner — Susan Moon Lee

(74) *Attorney, Agent, or Firm* — Law Offices of Steven W. Weinrieb

(57) **CLAIM**

The ornamental design for a pet travel cup, as shown and described.

DESCRIPTION

FIG. 1 is a front, right side, top perspective view of a pet travel cup showing my new design; FIG. 2 is a front elevational view thereof; FIG. 3 is a rear elevational view thereof; FIG. 4 is a left side elevational view thereof; FIG. 5 is a right side elevational view thereof; FIG. 6 is a top plan view thereof; and FIG. 7 is a bottom plan view thereof; and, FIG. 8 is a front, right side, top perspective view thereof showing the pet travel cup in a collapsed state suitable for travel. The broken lines depict portions of the pet travel cup that form no part of the claimed design.

1 Claim, 8 Drawing Sheets

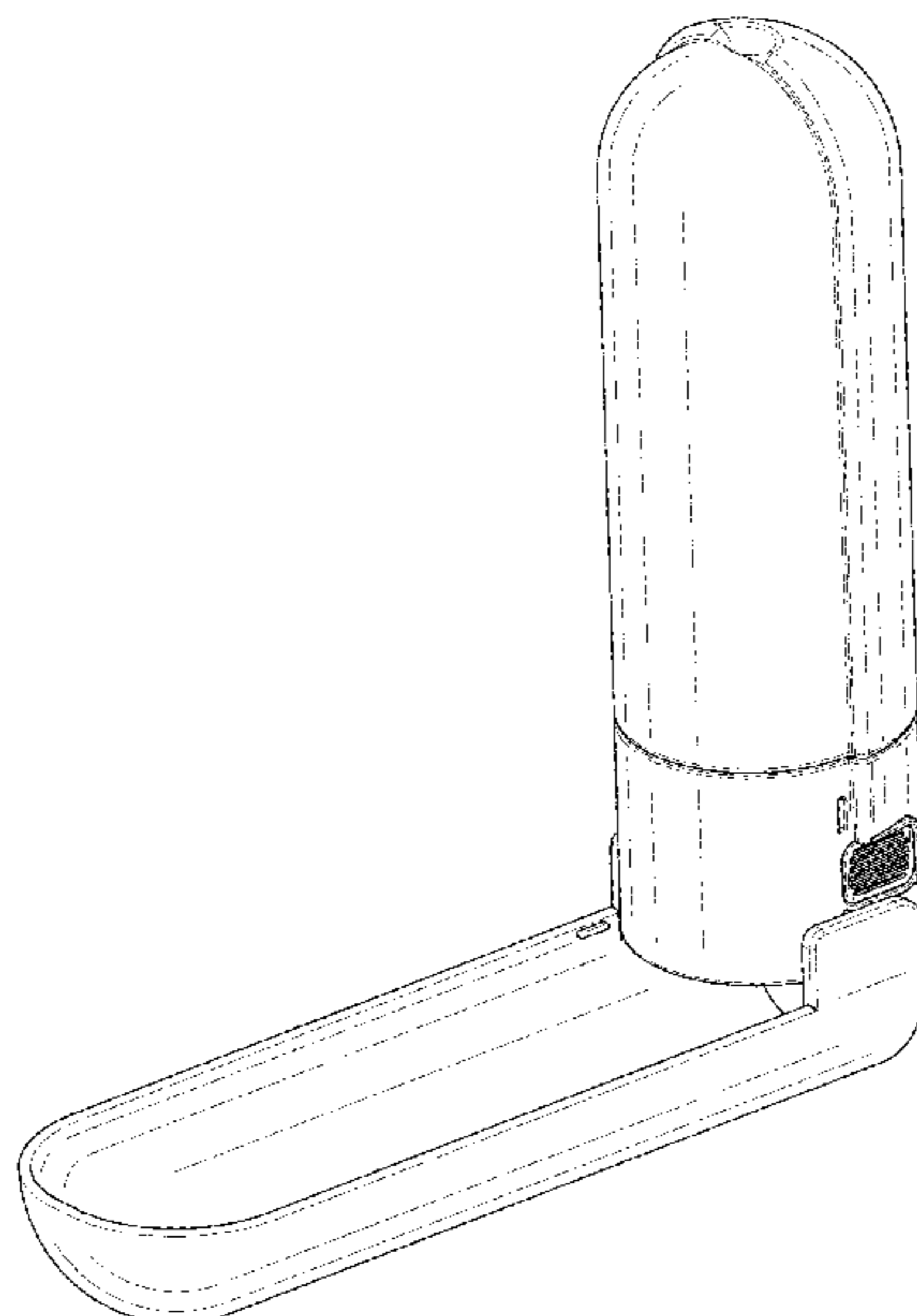

US D952,267 S

(58) **Field of Classification Search**

USPC 206/514, DIG. 10, 217, 543, 544, 546,
 206/549, 223, 241, 541, 518, 522, 557,
 206/591; 224/148.4, 148.7, 650
 CPC . A01K 7/00; A01K 7/005; A01K 7/02; A01K
 7/022; A01K 7/06; A01K 39/0213; A01K
 39/02; B65D 41/26; B65D 41/265; B65D
 41/28; B65D 41/32; B65D 41/325; B65D
 41/34; B65D 41/56; B65D 51/20; B65D
 51/249; B65D 51/24; B65D 51/28; B65D
 47/243; B65D 2205/04; B65D 21/0238;
 B65D 81/3205; B65D 81/3216; B65D
 71/50; B65D 77/2024; B65D 43/0212;
 B65D 2517/0049; B65D 2543/00046;
 B65D 2543/00092; B65D 2543/00537;
 B65D 2543/00731; B65D 2543/00796;
 B65D 2577/205; A61J 9/00; A61J 9/006;
 A61J 9/001; A61J 9/003; A61J 11/04;
 A61J 19/00; B65B 39/00; B65B 39/001;
 B65B 39/005; B65B 39/007; B67C 11/02;
 G01F 11/286; B67B 7/28

See application file for complete search history.

(56) **References Cited**

U.S. PATENT DOCUMENTS

4,603,784 A * 8/1986 Chang A61J 9/008
 215/11.1
 D294,750 S * 3/1988 Atchley D30/132
 D300,963 S * 5/1989 Atchley D30/132
 5,377,879 A * 1/1995 Isaacs A61J 7/0023
 222/192
 5,441,017 A * 8/1995 Lindsay A01K 27/003
 119/161
 5,636,592 A * 6/1997 Wechsler A01K 7/02
 119/52.1
 5,960,742 A * 10/1999 O'Rourke A01K 7/00
 119/74
 D423,736 S * 4/2000 O'Rourke D30/132
 6,279,233 B1 * 8/2001 Cameron A61J 7/0023
 30/125
 D468,489 S * 1/2003 Wechsler D30/132
 6,604,649 B1 * 8/2003 Campi B65D 81/3886
 220/592.17
 7,287,487 B2 * 10/2007 Hurwitz A01K 7/00
 119/74
 D577,584 S * 9/2008 Porter D9/447
 D580,227 S * 11/2008 Roth D7/392.1
 D580,715 S * 11/2008 Finell D7/643
 7,490,577 B2 * 2/2009 Stephanos A01K 7/00
 119/52.1
 7,690,329 B2 * 4/2010 Parks A01K 7/00
 119/74
 8,020,303 B1 * 9/2011 Marsh A47G 21/004
 30/324

D646,919 S * 10/2011 Nilsson B65D 47/148
 D7/300.1
 D658,064 S * 4/2012 Barnes D9/532
 8,272,351 B2 * 9/2012 Hurwitz A01K 7/00
 119/74
 D670,134 S * 11/2012 Di Lollo D7/507
 D705,501 S * 5/2014 Li D30/132
 D711,740 S * 8/2014 Lien D9/436
 D728,169 S * 4/2015 Yacov D30/121
 D739,984 S * 9/2015 Harvey D30/132
 9,351,475 B2 * 5/2016 Yacov A01K 7/00
 D774,834 S * 12/2016 Breit D7/587
 D809,845 S * 2/2018 Marchitello D7/306
 10,085,543 B2 * 10/2018 Breit B65D 23/003
 D832,650 S * 11/2018 Diebel D7/511
 D850,017 S * 5/2019 Brucato D30/132
 D854,256 S * 7/2019 Flores D30/132
 D854,378 S * 7/2019 Breit D7/507
 D861,258 S * 9/2019 Liang D30/132
 D871,839 S * 1/2020 Sun D7/507
 D875,327 S * 2/2020 Gong D30/132
 D906,601 S * 12/2020 Roost D30/132
 D917,108 S * 4/2021 Xie D30/132
 D936,296 S * 11/2021 Chen D30/121
 2004/0006874 A1 * 1/2004 Kamm B65D 51/246
 30/141
 2006/0278169 A1 * 12/2006 Logan A01K 5/0114
 119/61.56
 2007/0017450 A1 * 1/2007 Hurwitz A01K 7/00
 119/74
 2007/0017451 A1 * 1/2007 Hurwitz A01K 7/00
 119/74
 2007/0017452 A1 * 1/2007 Hurwitz A01K 7/00
 119/74
 2007/0079762 A1 * 4/2007 Stephanos A01K 7/00
 119/74
 2008/0087224 A1 * 4/2008 Wechsler A01K 7/00
 119/52.1
 2009/0159009 A1 * 6/2009 Parks A01K 7/00
 119/74
 2012/0298045 A1 * 11/2012 Wechsler A01K 7/00
 119/52.1
 2014/0209032 A1 * 7/2014 Li A01K 7/00
 119/74
 2014/0261198 A1 * 9/2014 Wechsler A01K 7/00
 119/52.1
 2014/0360434 A1 * 12/2014 Yacov A01K 5/0114
 119/51.5
 2015/0298867 A1 * 10/2015 Sanderson A47G 19/2266
 215/6
 2016/0280447 A1 * 9/2016 Beardsell B65D 47/148
 2016/0316896 A1 * 11/2016 Breit A01K 7/00
 2017/0127859 A1 * 5/2017 Hornung A45F 3/18
 2017/0354120 A1 * 12/2017 Yang B65D 51/18
 2019/0216052 A1 * 7/2019 Yang A01K 7/00
 2019/0380541 A1 * 12/2019 Yurkovetskaya .. B65D 43/0231
 2021/0068367 A1 * 3/2021 Gong A01K 7/00

* cited by examiner

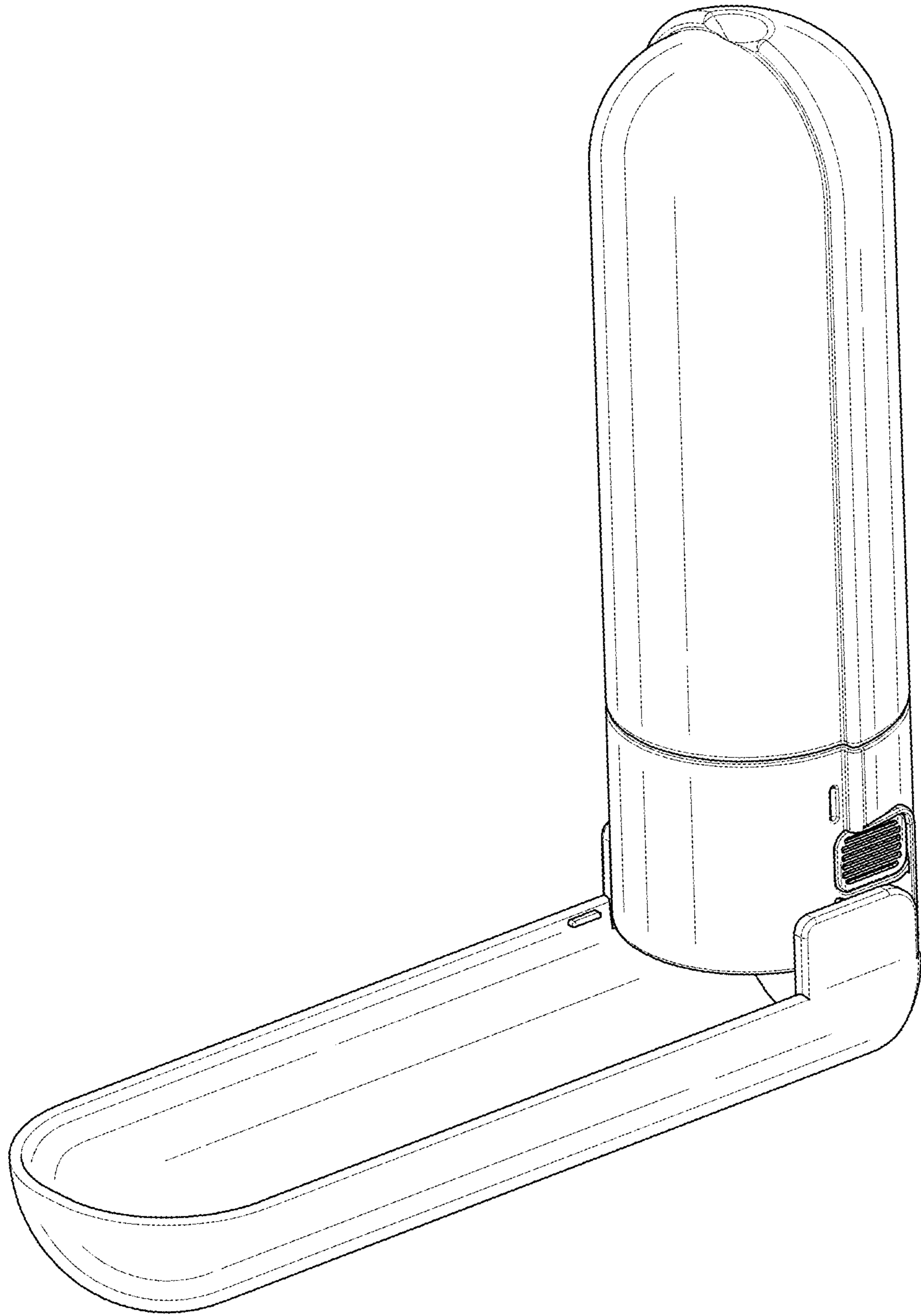

FIG.1

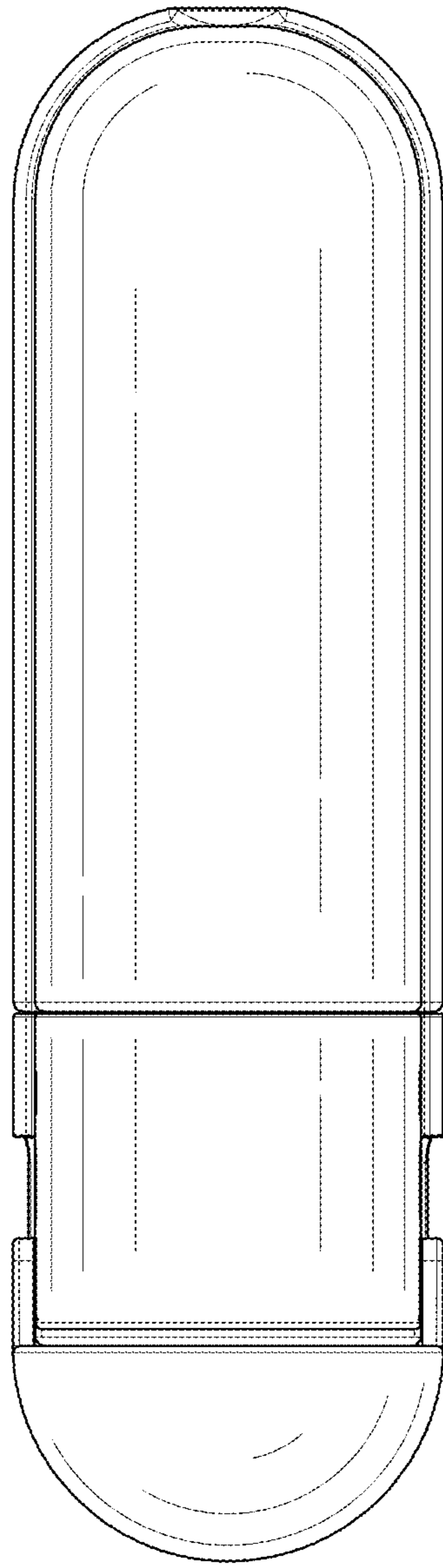

FIG.2

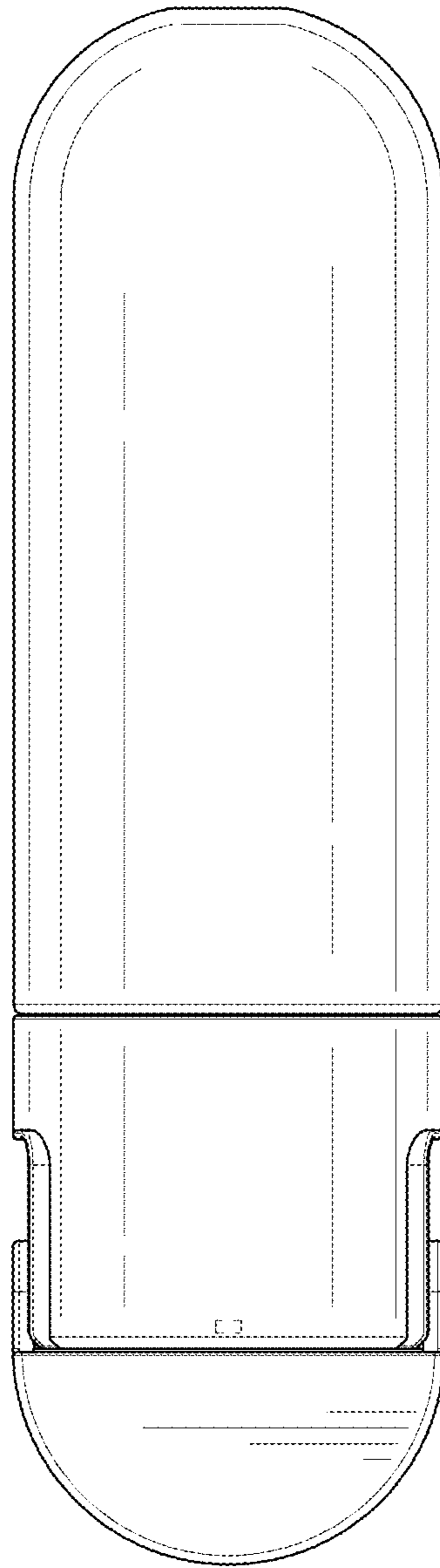

FIG.3

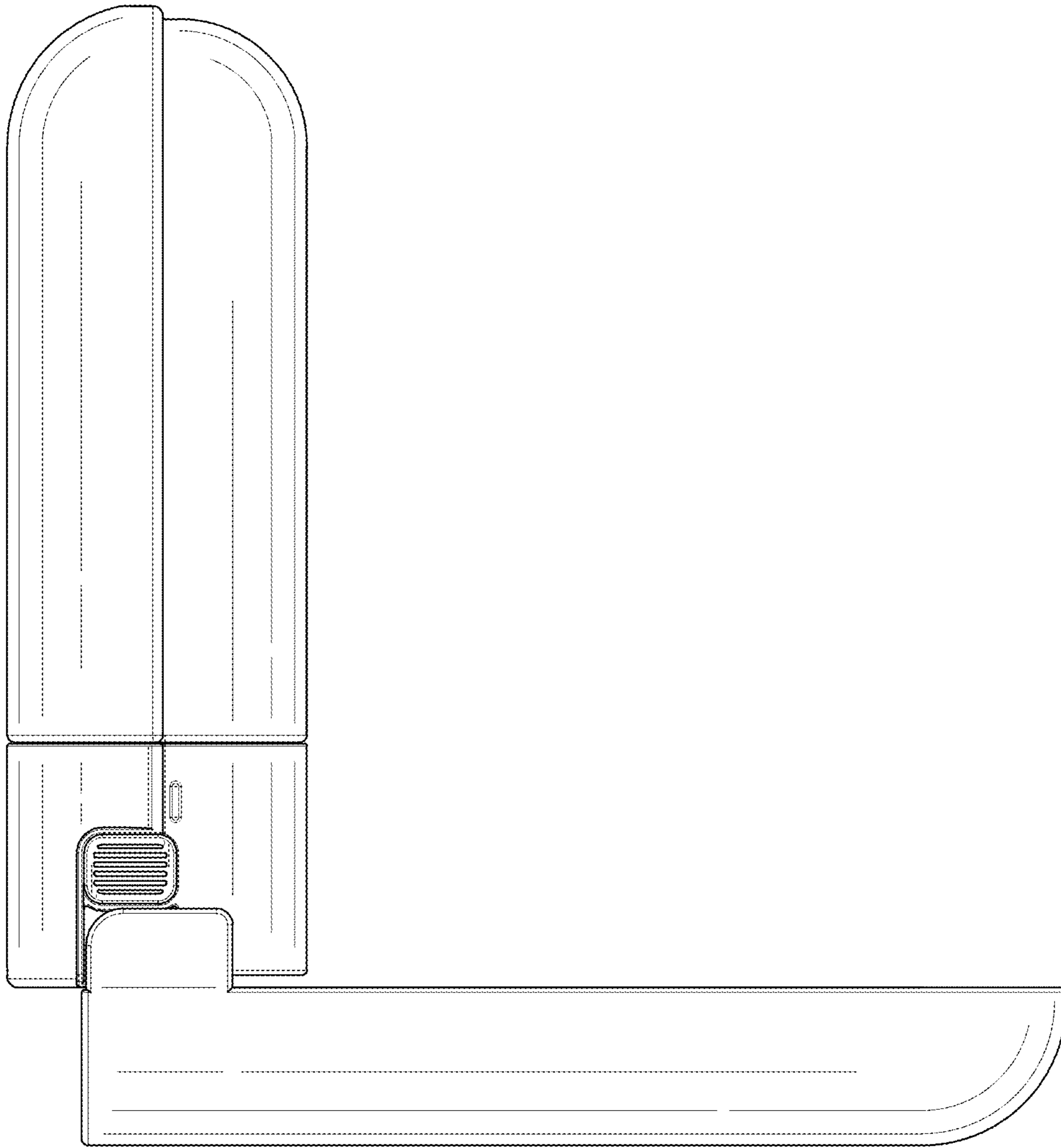

FIG. 4

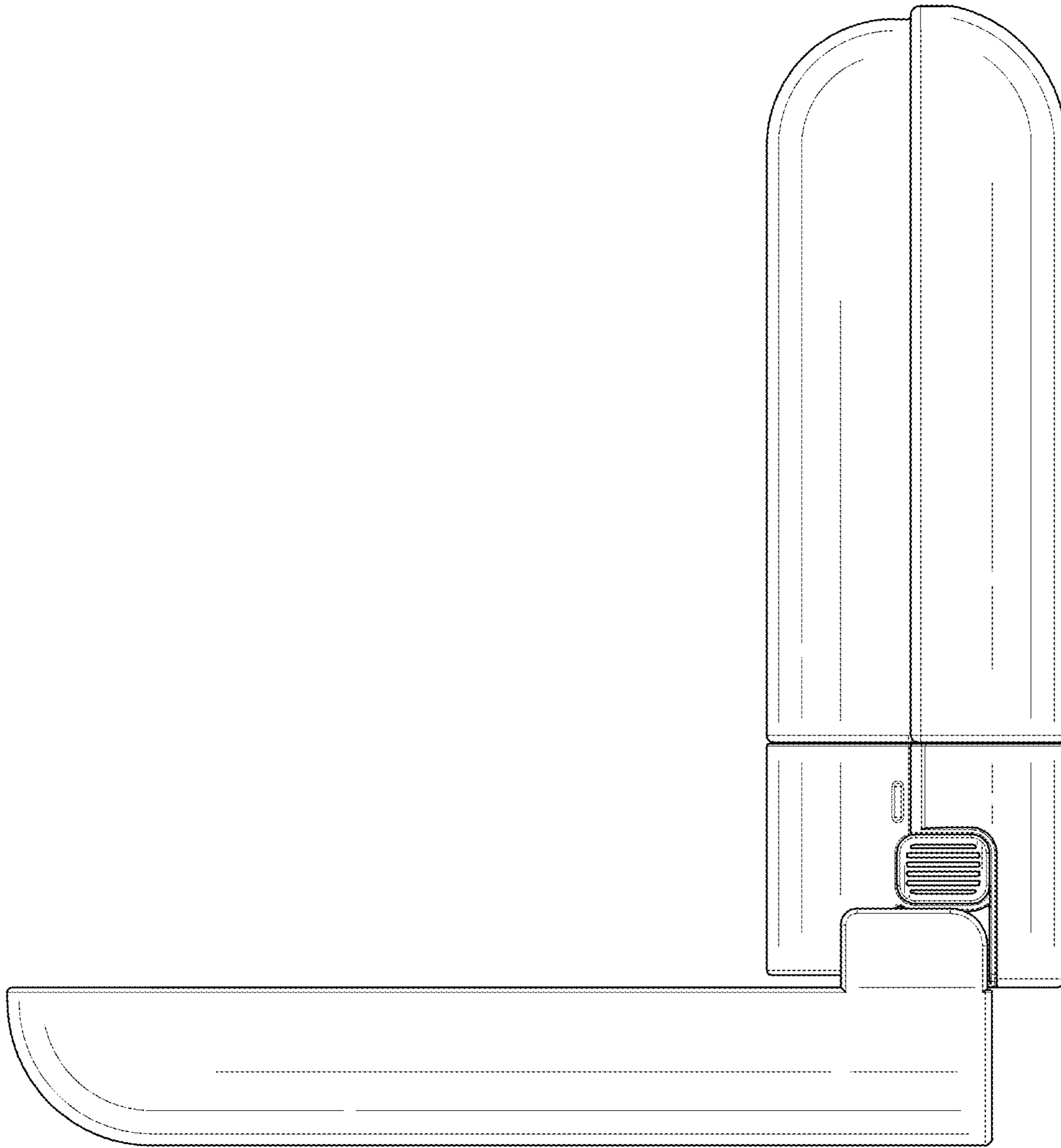

FIG. 5

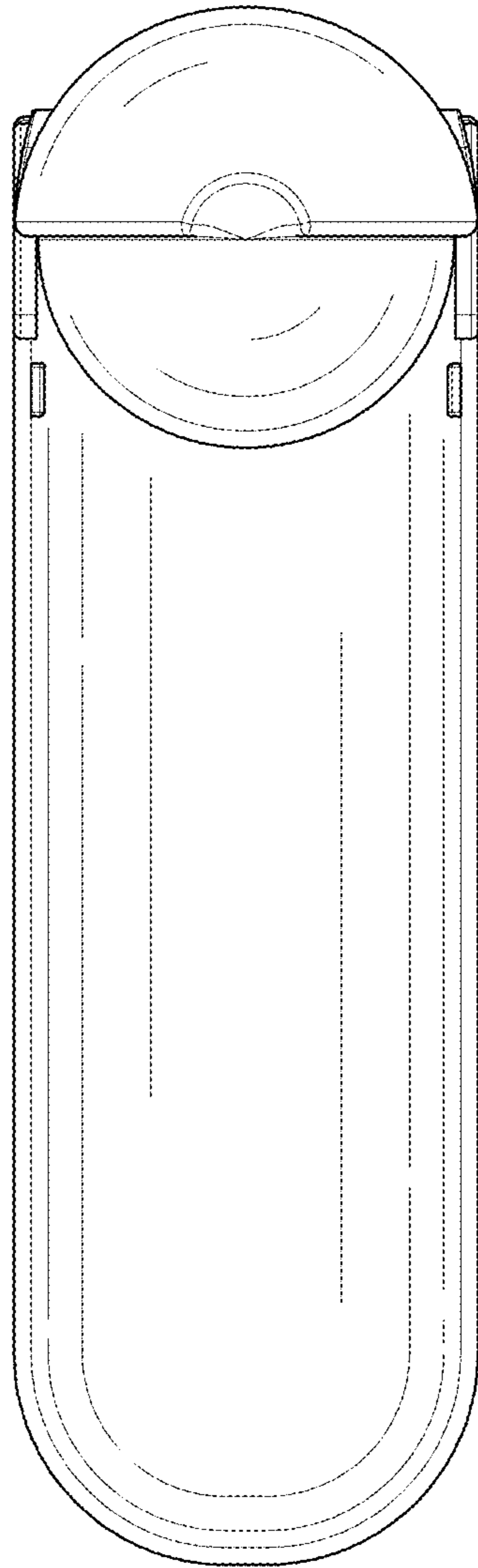

FIG.6

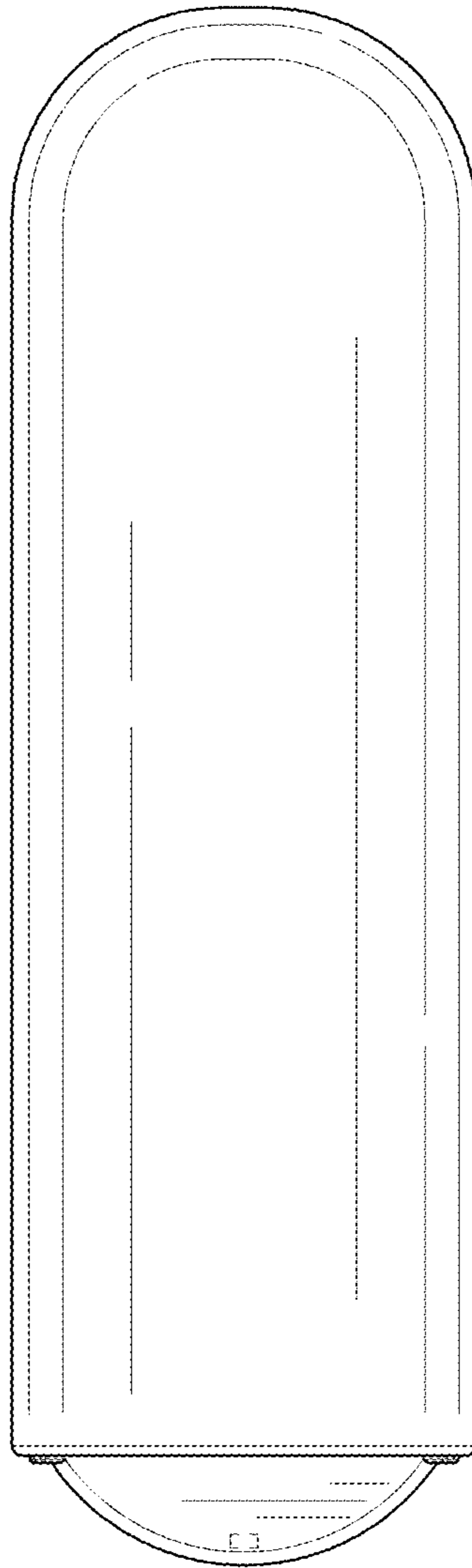

FIG. 7

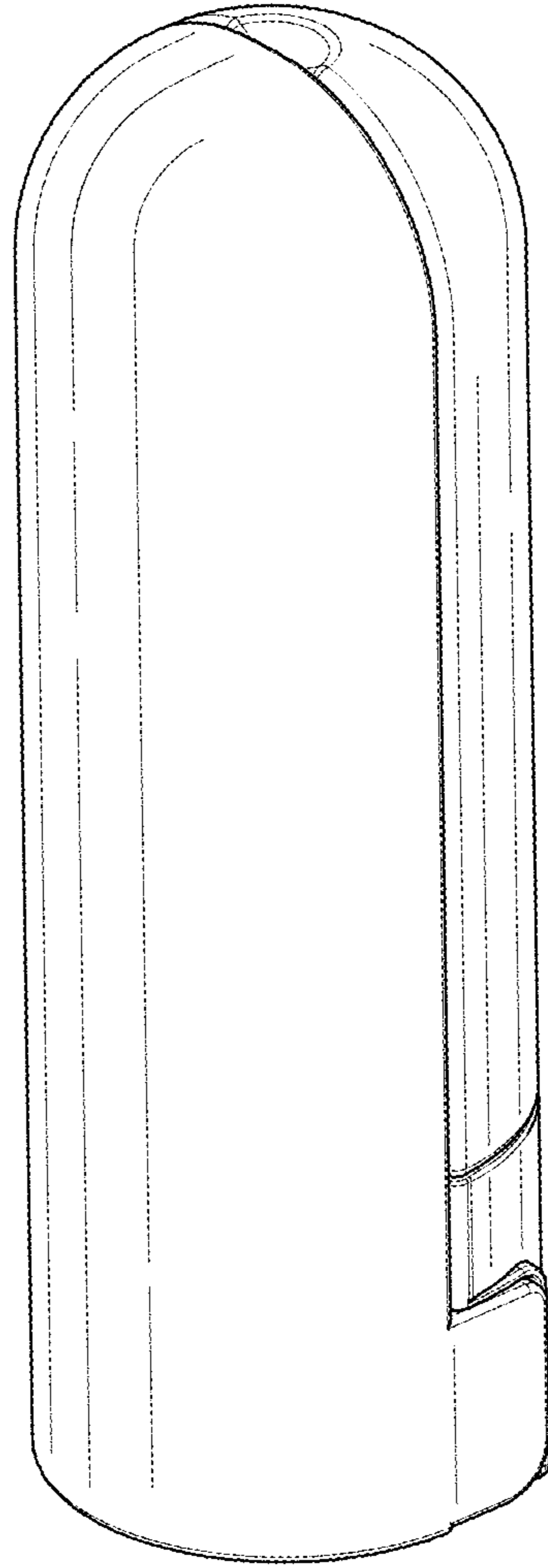

FIG.8