



US00D952262S

(12) **United States Design Patent** (10) **Patent No.:** **US D952,262 S**
Feng (45) **Date of Patent:** **** May 17, 2022**

(54) **PET BAG**

D804,108 S * 11/2017 Torres D30/109
D808,084 S * 1/2018 Lu D30/109
D845,554 S * 4/2019 Lanzkowsky D30/109

(71) Applicant: **GUANGZHOU WENYI COMMUNICATION EQUIPMENT CO., LTD**, Guangzhou (CN)

(Continued)

(72) Inventor: **YouRu Feng**, Guangzhou (CN)

(73) Assignee: **GUANGZHOU WENYI COMMUNICATION EQUIPMENT CO., LTD**, Guangzhou (CN)

OTHER PUBLICATIONS

“PetsHome Dog Carrier Purse”, posted Oct. 11, 2016[Online],[Retrieved Aug. 11, 2020], retrieved from Internet: https://www.amazon.com/product-reviews/B073XNNG7F/ref=cm_cr_getr_d_paging_btm_next_27?ie=UTF8&showViewpoints=1&filterByStar=positive&pageNumber=27&sortBy=recent.*

(**) Term: **15 Years**

Primary Examiner — Mehri F Bajoul

(21) Appl. No.: **29/704,124**

(74) *Attorney, Agent, or Firm* — Zhihua Han; Wen IP LLC

(22) Filed: **Sep. 2, 2019**

(57) **CLAIM**

(51) **LOC (13) Cl.** **30-02**

The ornamental design for a pet bag, as shown and described.

(52) **U.S. Cl.**

USPC **D30/108**

DESCRIPTION

(58) **Field of Classification Search**

USPC D30/108, 109, 150; D3/213, 216, 246, D3/273, 315; 119/452, 474, 482, 489, 119/491, 496, 499, 500, 513, 650, 673, 119/678, 712, 751; 224/153, 202, 258, 224/579

FIG. 1 is a perspective view of a pet bag showing my new design with the window in an open position; FIG. 2 is an alternate perspective view of the pet bag showing the top cover in an open state, the window in a closed position, and the handles set on the sides; FIG. 3 is a front elevational view thereof, showing the design in in an alternate position, with the top cover and the window in closed state and the handles set on the top side; FIG. 4 is an alternate front elevational view thereof; showing the window in an open state; FIG. 5 is a left side elevational view thereof; showing the window and the top cover in closed state; FIG. 6 is a right side elevational view thereof; FIG. 7 is a top plan view thereof; and, FIG. 8 is a bottom plan view thereof.

CPC A01K 1/0254; A45C 3/00; A45C 13/30; B62B 5/0013

See application file for complete search history.

The dash-dot-dash lines depict portions of the pet bag that form no part of the claimed design. The zipper sliders shown in short dashed broken lines depict portions that from no part of the claimed design. The short dashed broken lines disclose stitching which forms part of the claimed design.

(56) **References Cited**

U.S. PATENT DOCUMENTS

D575,461 S * 8/2008 Cannon D3/273
D649,719 S * 11/2011 Siklosi D30/109
D662,263 S * 6/2012 Chau D30/109
D677,011 S * 2/2013 Cirincione D30/109
D685,952 S * 7/2013 Dixon D30/109
D707,896 S * 6/2014 Renforth D30/108
D717,502 S * 11/2014 Dixon D30/109
D724,792 S * 3/2015 Renforth D30/109
D727,573 S * 4/2015 Eisen D30/109
D753,347 S * 4/2016 Lu D30/109

1 Claim, 8 Drawing Sheets

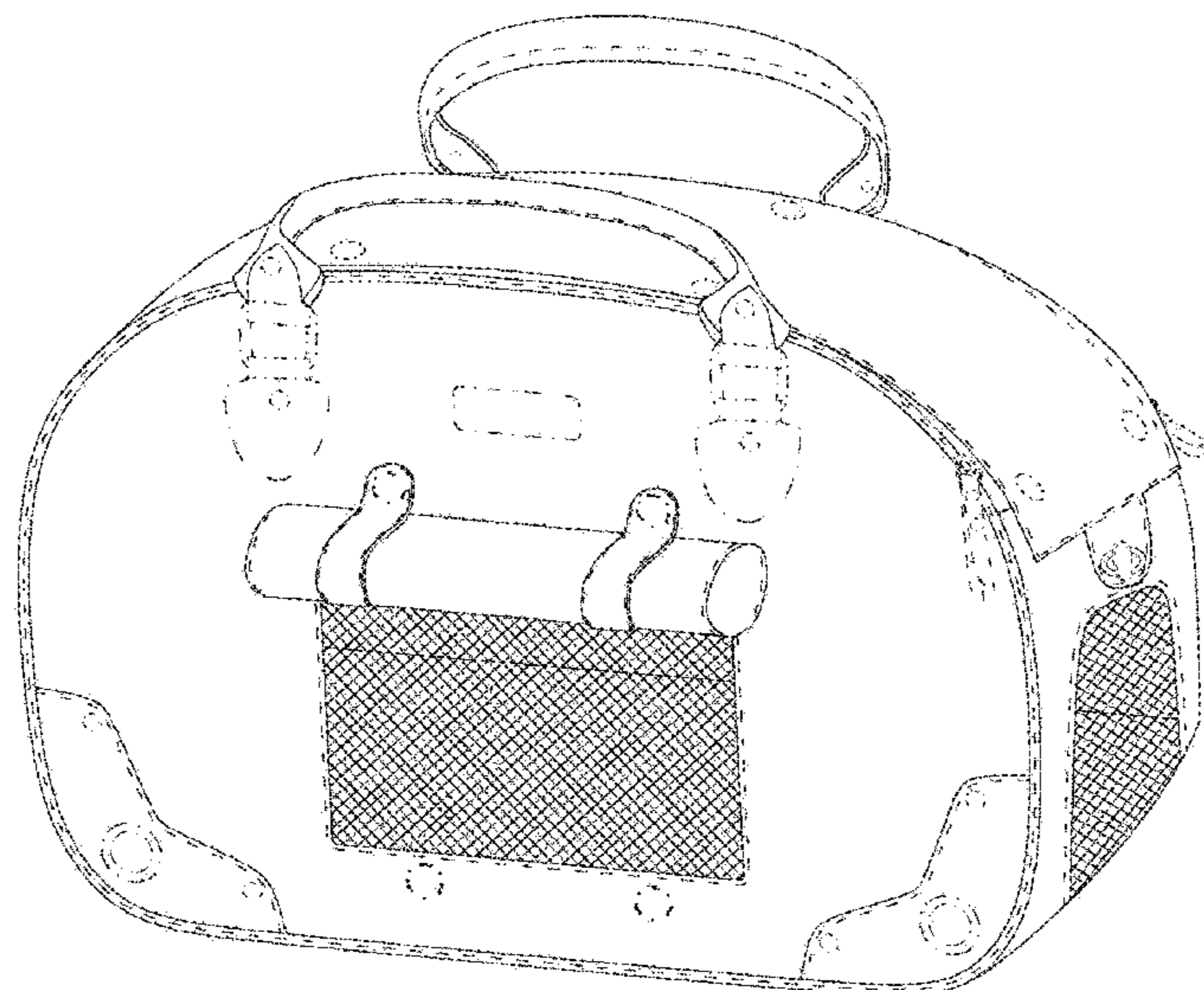

(56)

References Cited

U.S. PATENT DOCUMENTS

D849,333 S * 5/2019 Laicheng D30/109
D855,900 S * 8/2019 Lu D30/109
D872,945 S * 1/2020 Lu D30/109
2008/0216760 A1* 9/2008 Cannon A01K 1/0254
119/497
2010/0000472 A1* 1/2010 Siklosi A01K 1/0272
119/497
2018/0338469 A1* 11/2018 Alexander A01K 1/0254

* cited by examiner

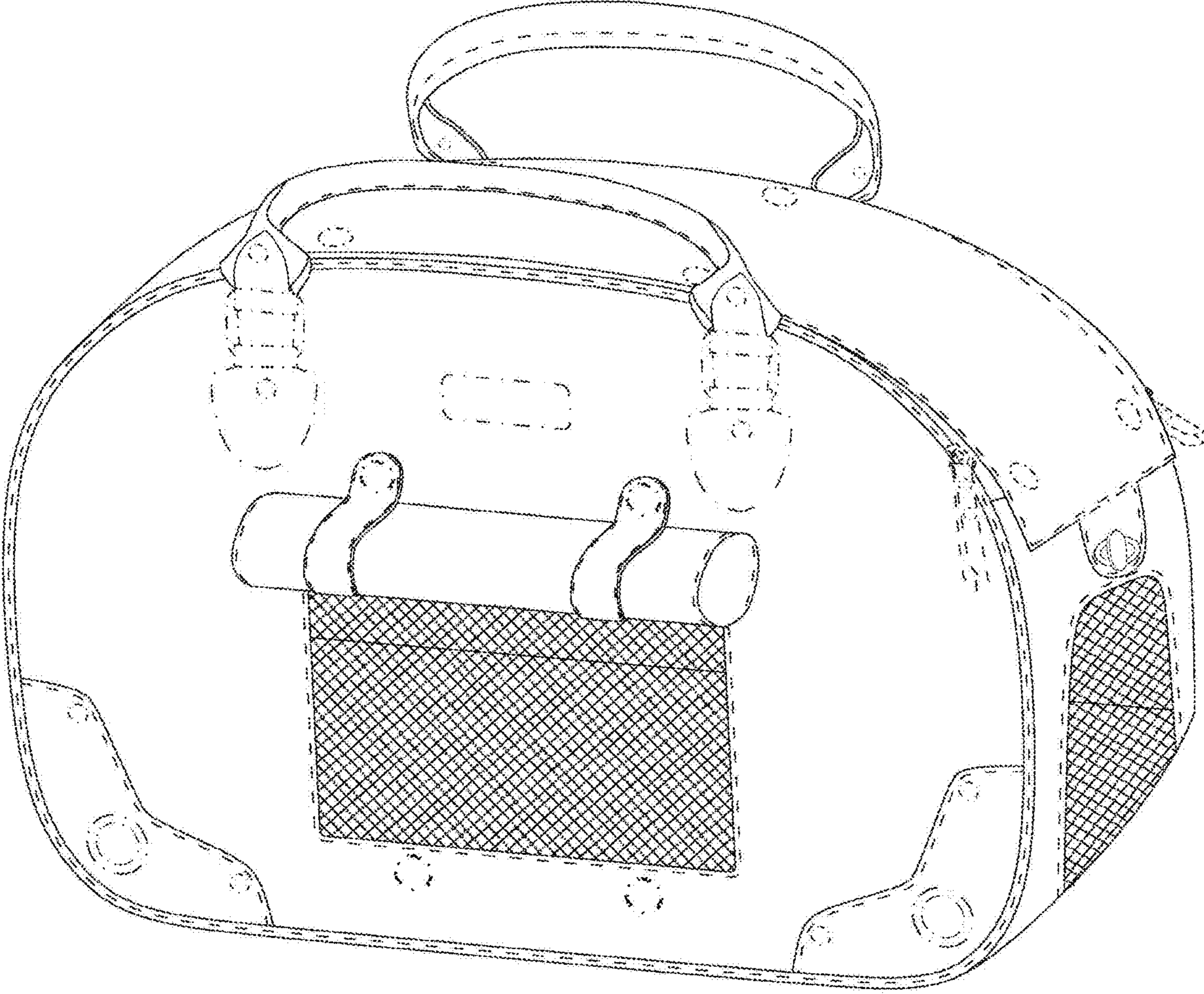

FIG. 1

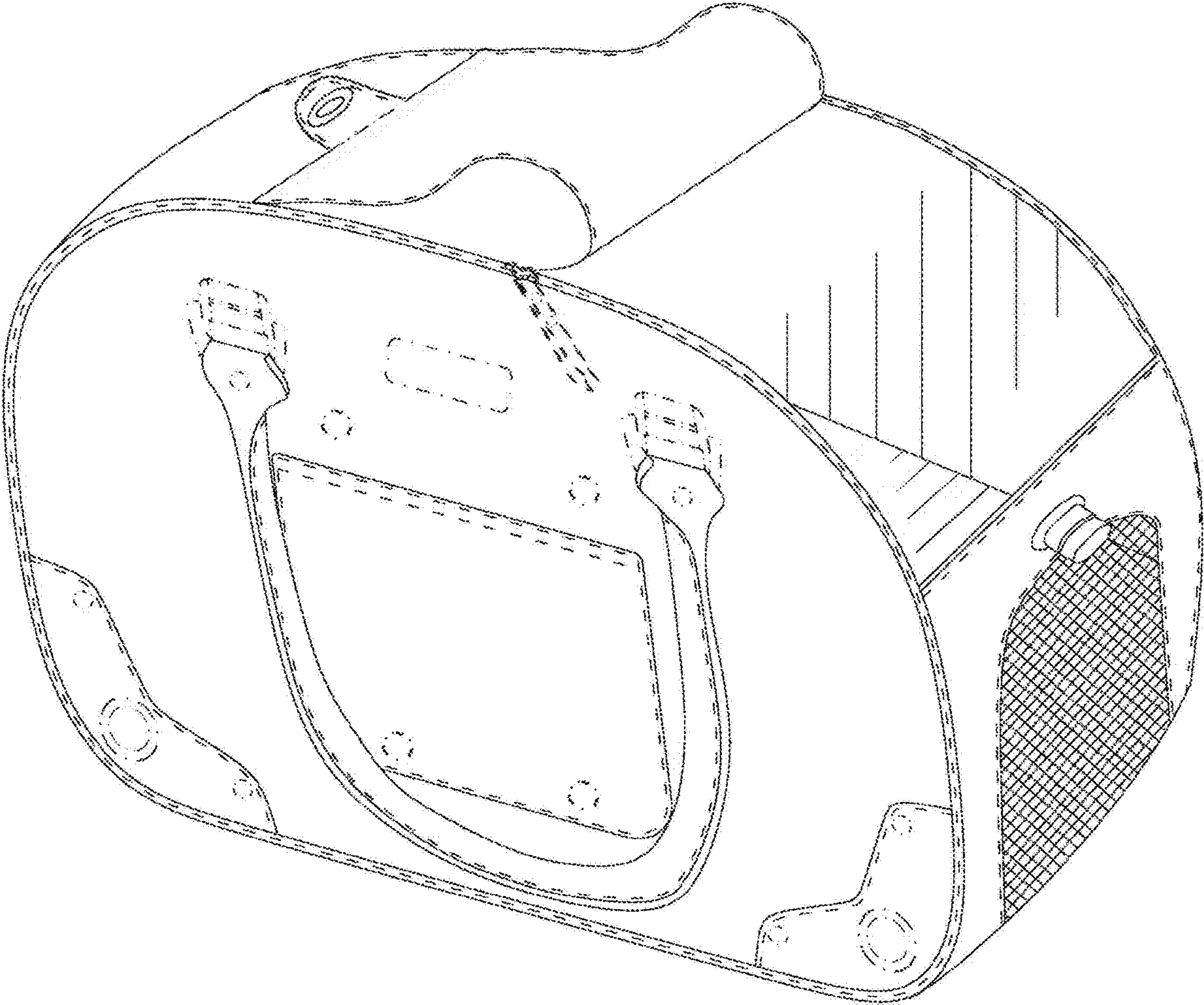

FIG. 2

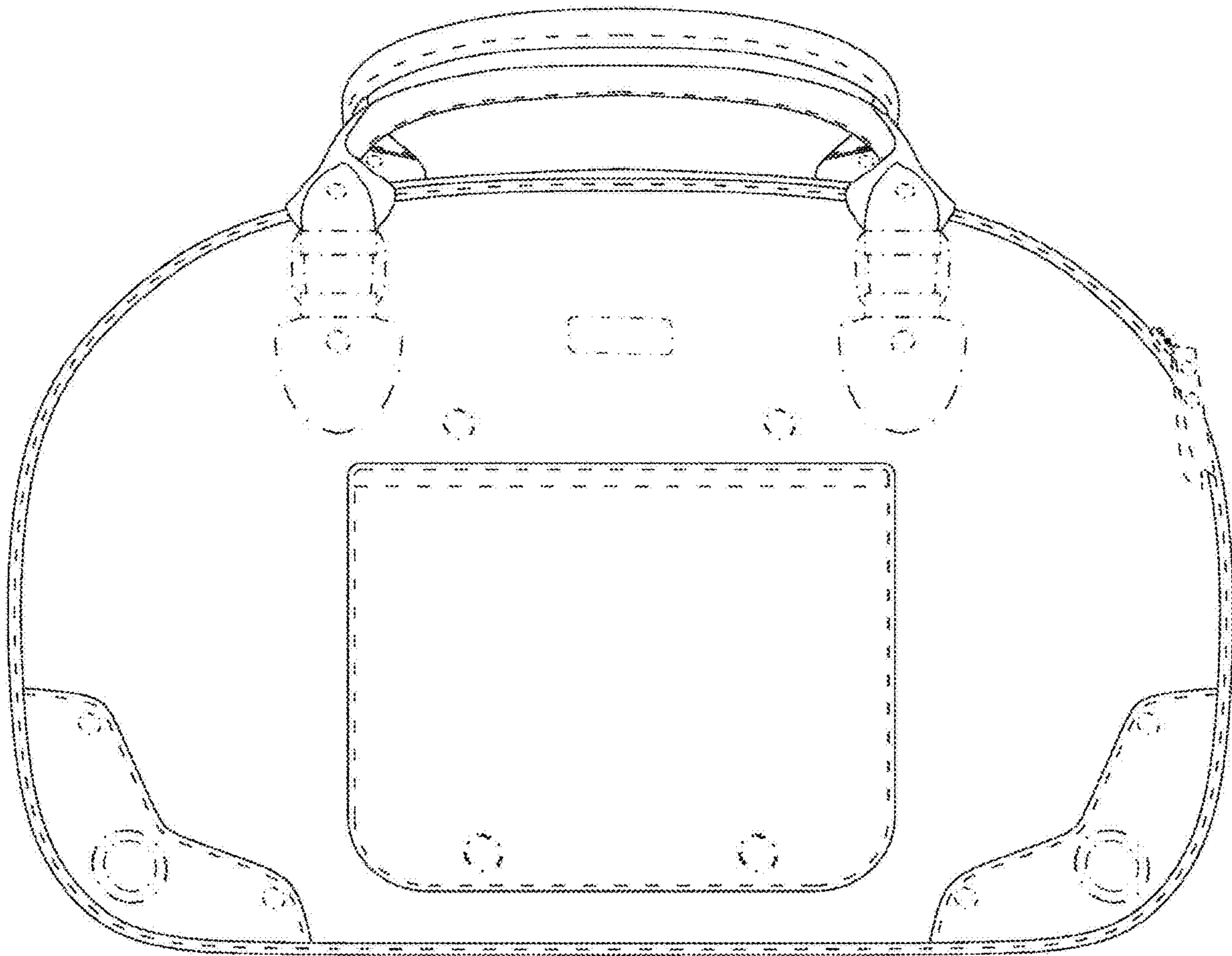

FIG. 3

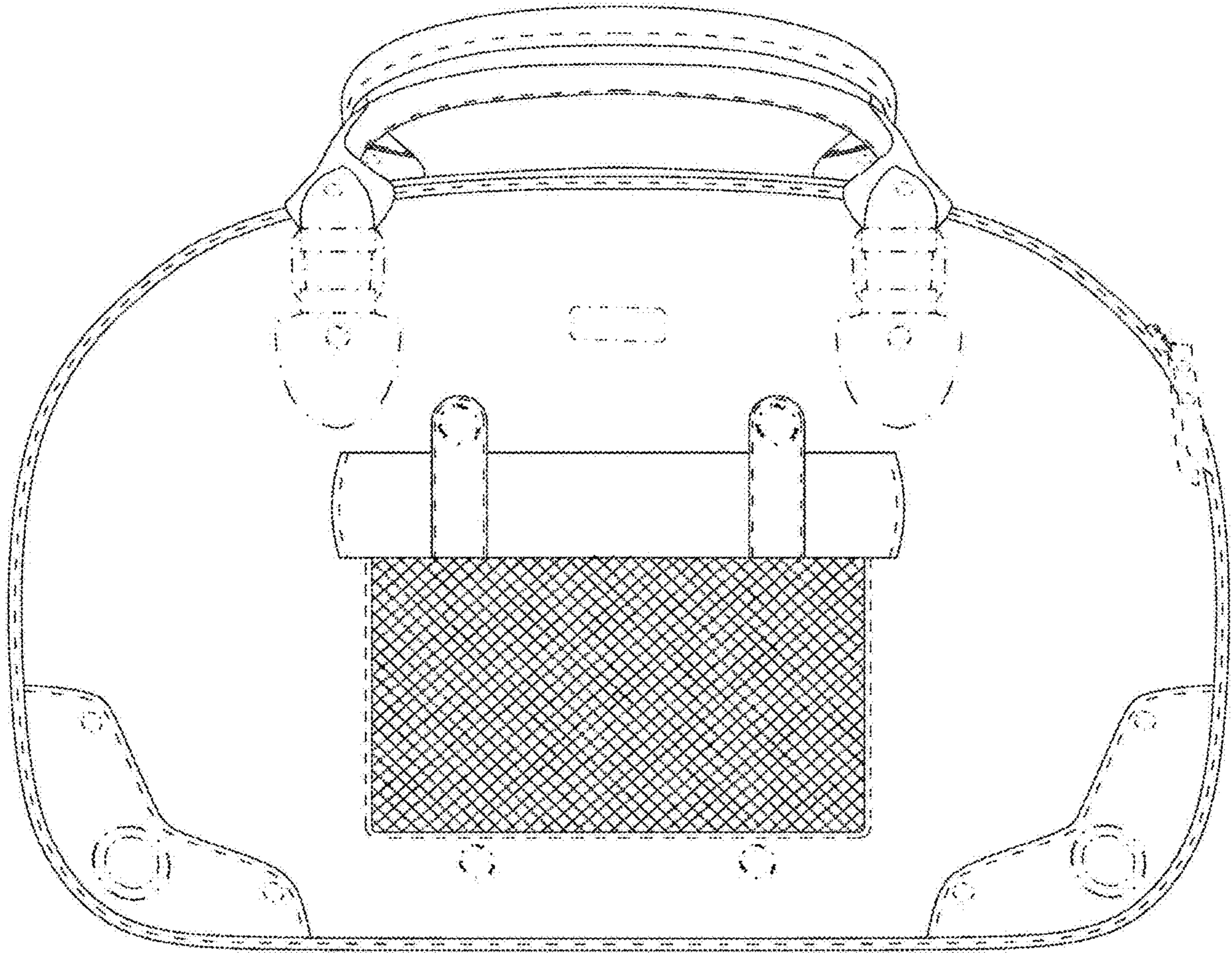

FIG. 4

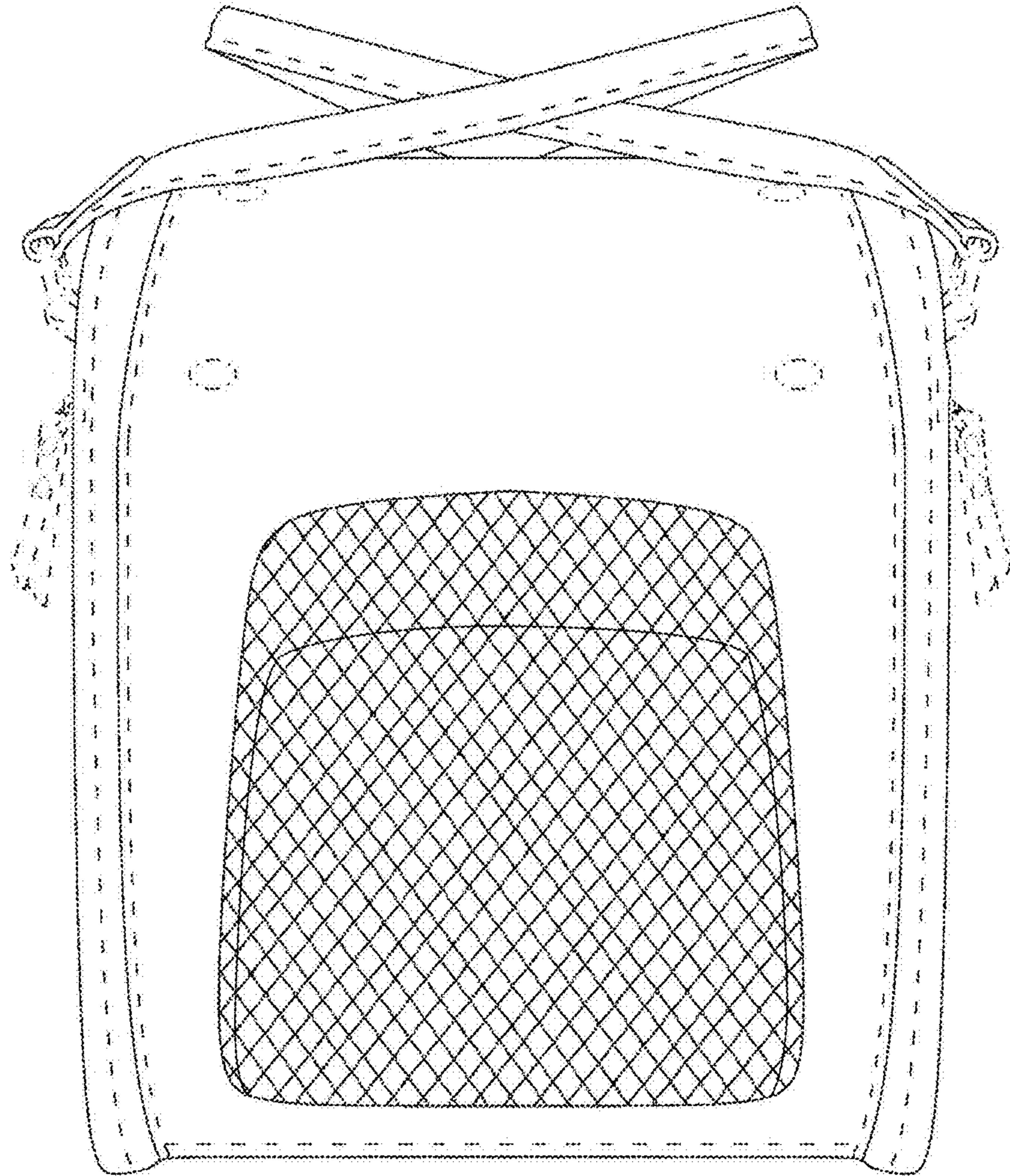

FIG. 5

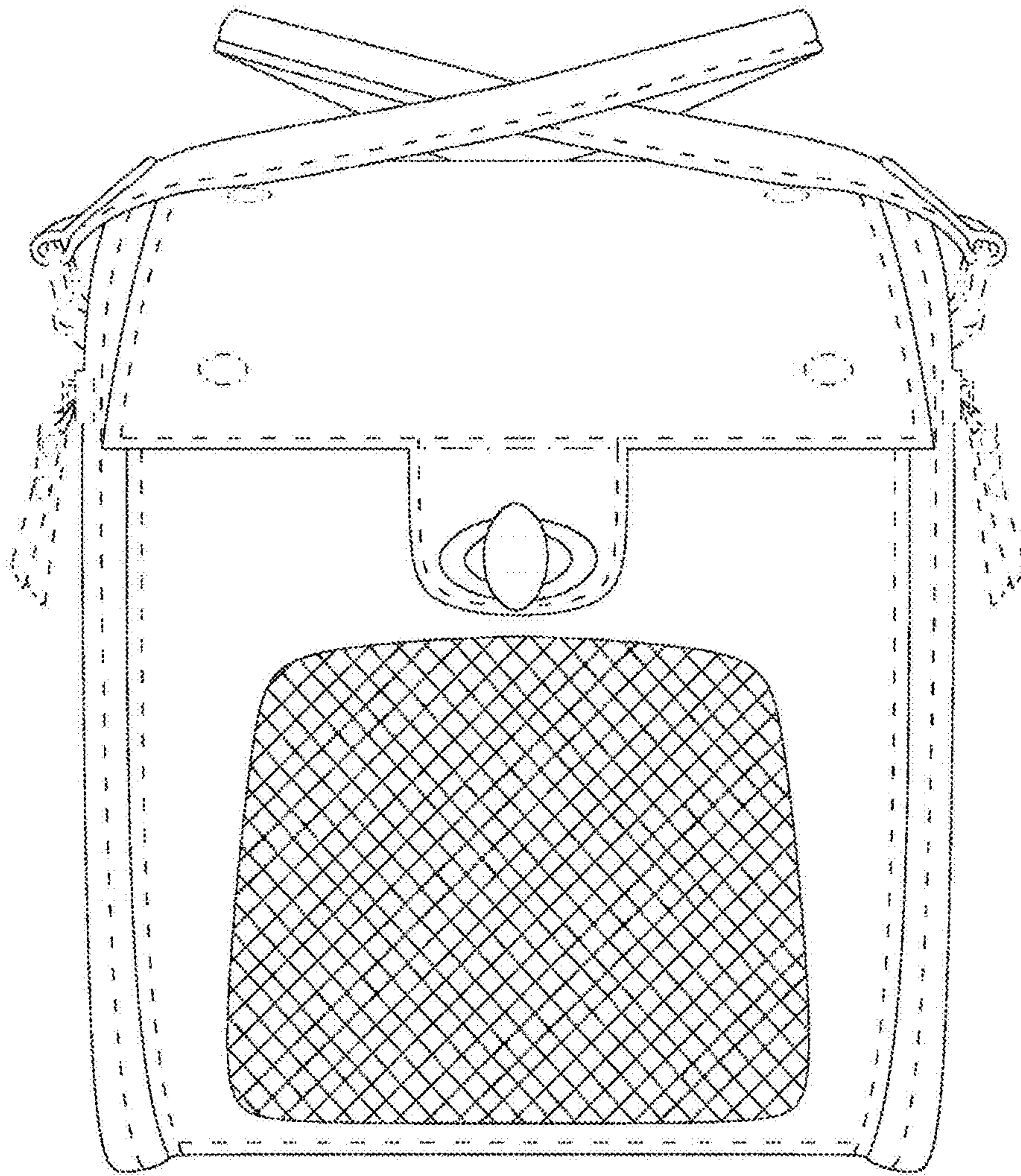

FIG. 6

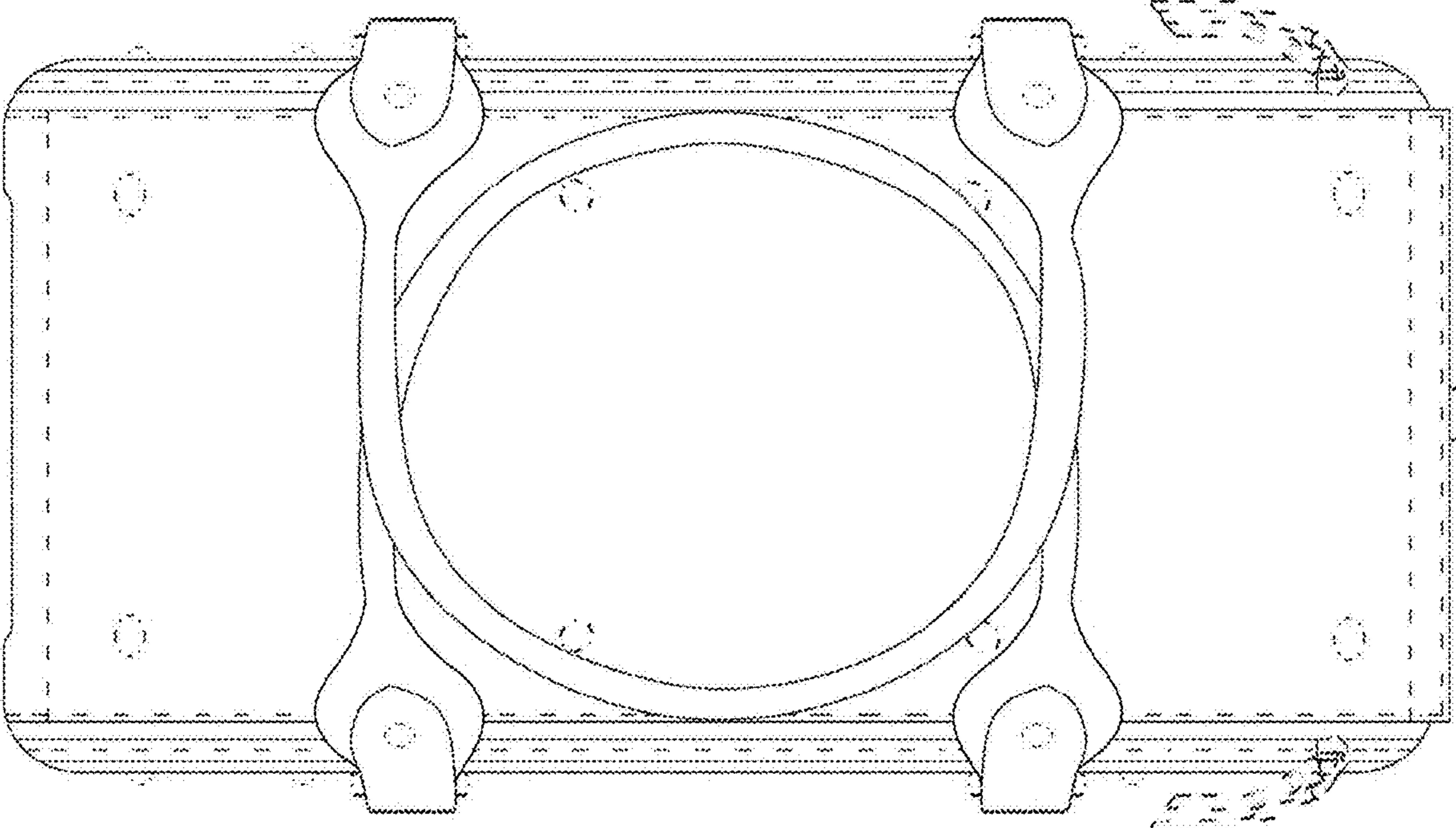

FIG. 7

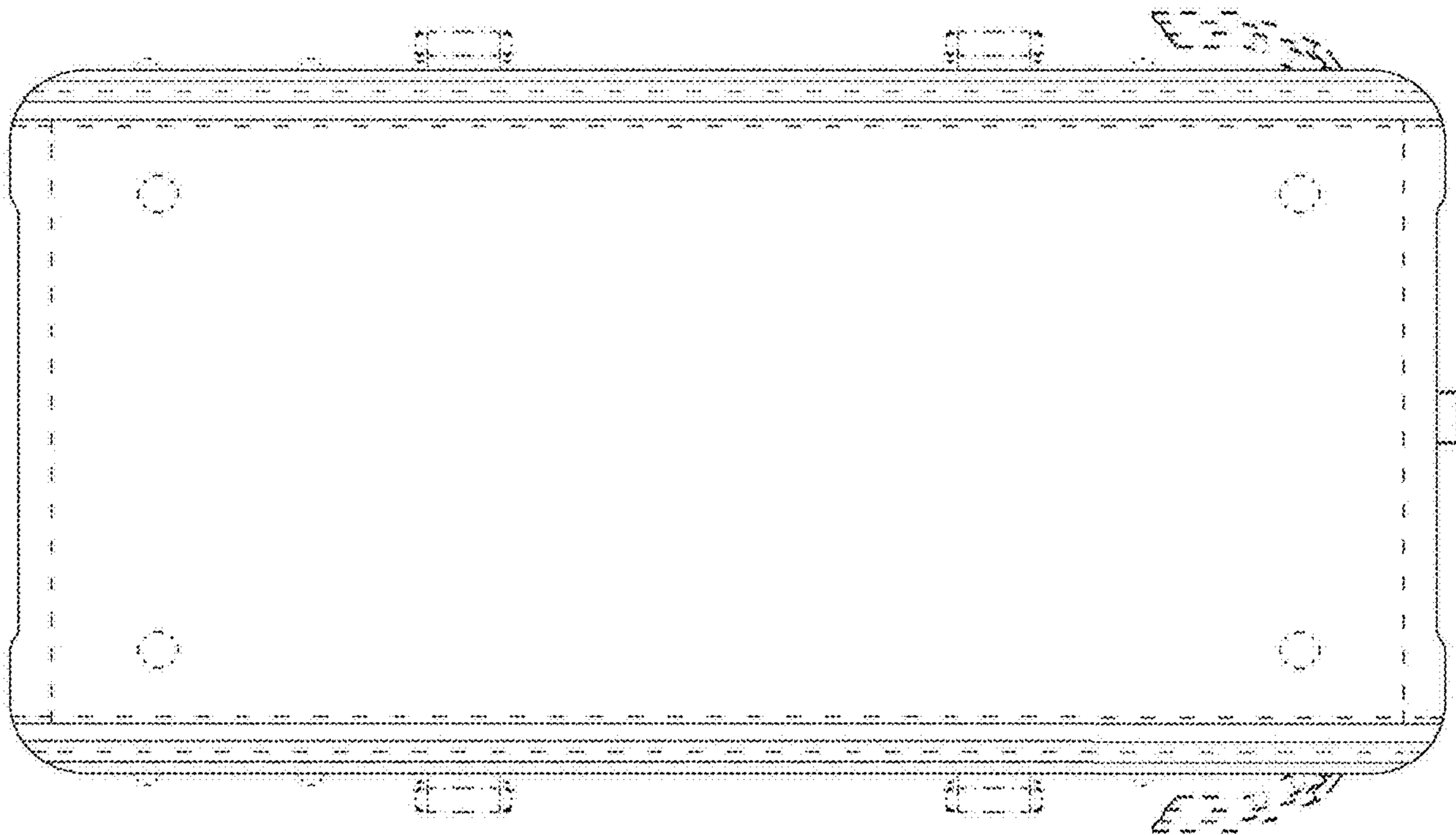

FIG. 8