



US00D952256S

(12) **United States Design Patent**  
**Langberg**

(10) **Patent No.:** **US D952,256 S**  
(45) **Date of Patent:** **\*\* May 17, 2022**

- (54) **GUARD FOR HAIR REMOVAL DEVICE**
- (71) Applicant: **Church & Dwight Co., Inc.**, Princeton, NJ (US)
- (72) Inventor: **Eric Langberg**, Milford, PA (US)
- (73) Assignee: **Church & Dwight Co., Inc.**, Princeton, NJ (US)
- (\*\*) Term: **15 Years**
- (21) Appl. No.: **29/810,008**
- (22) Filed: **Sep. 30, 2021**

4,996,772	A	3/1991	Iten	
6,185,823	B1	2/2001	Brown et al.	
6,418,623	B1	7/2002	Marcarelli	
7,681,314	B2	3/2010	Follo	
D624,242	S	9/2010	Bridges et al.	
D790,769	S *	6/2017	Drori	D28/54
9,751,226	B2	9/2017	Psimadas et al.	
9,919,441	B2	3/2018	Drori	
10,780,596	B2	9/2020	Squires et al.	
D921,293	S *	6/2021	Langberg	D28/47
2008/0216320	A1	9/2008	Royle et al.	
2012/0324737	A1	12/2012	Howell et al.	
2017/0305022	A1	10/2017	Bamundaga	
2018/0161999	A1	6/2018	Depaz	
2019/0118397	A1 *	4/2019	Drori	B26B 21/4037
2019/0299439	A1	10/2019	Park et al.	
2019/0351569	A1	11/2019	Squires et al.	
2020/0061856	A1	2/2020	Musallam et al.	
2020/0290223	A1	9/2020	Kole et al.	

**Related U.S. Application Data**

- (62) Division of application No. 29/712,099, filed on Nov. 5, 2019, now Pat. No. Des. 935,095.
- (51) **LOC (13) Cl.** ..... **28-03**
- (52) **U.S. Cl.**  
USPC ..... **D28/47; D28/54**
- (58) **Field of Classification Search**  
USPC ..... D28/49-54, 47  
CPC . B26B 21/42; B26B 21/4018; B26B 21/4025;  
B26B 21/4012; B26B 21/4037; B26B  
19/38; B26B 19/3806-388; B26B  
19/3886  
See application file for complete search history.

**References Cited**

**U.S. PATENT DOCUMENTS**

- (56) 2,608,756 A \* 9/1952 Jepson ..... B26B 19/3846  
30/540
- 3,388,468 A 6/1968 Hamill
- 3,408,737 A 11/1968 Steere, Jr. et al.
- 3,530,574 A 9/1970 Patterson
- 3,648,367 A 3/1972 Tolmie

\* cited by examiner

*Primary Examiner* — Jennifer Rivard

(74) *Attorney, Agent, or Firm* — Womble Bond Dickinson (US) LLP

(57) **CLAIM**

The ornamental design for a guard for hair removal device, as shown and described.

**DESCRIPTION**

FIG. 1 is a front perspective view of an embodiment of a guard for hair removal device of the present invention showing our new design;  
 FIG. 2 is a front view thereof;  
 FIG. 3 is a rear view thereof;  
 FIG. 4 is a side view thereof, the opposing side view being a mirror image thereof;  
 FIG. 5 is a top plan view thereof; and,  
 FIG. 6 is a bottom plan view thereof.

**1 Claim, 4 Drawing Sheets**

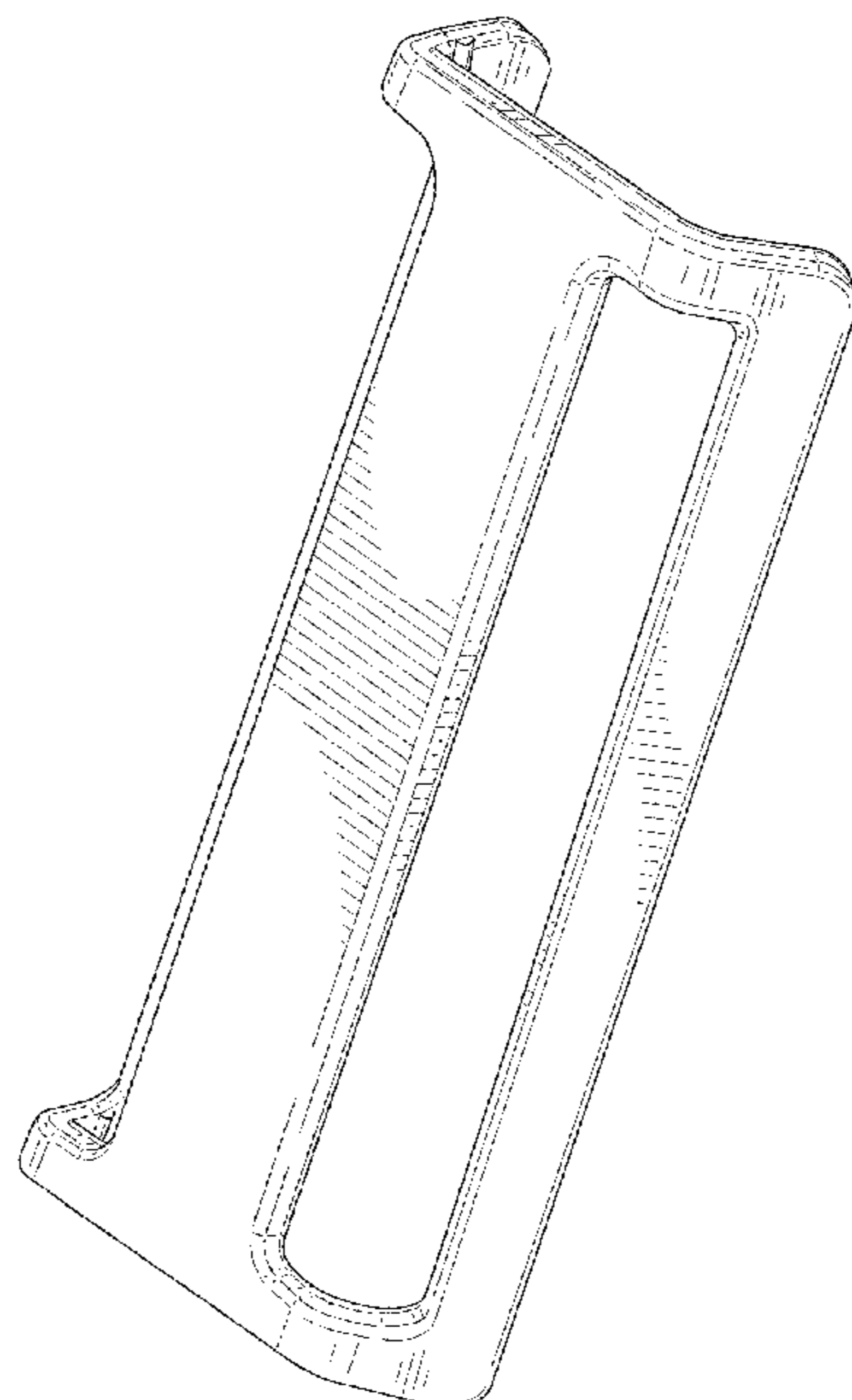

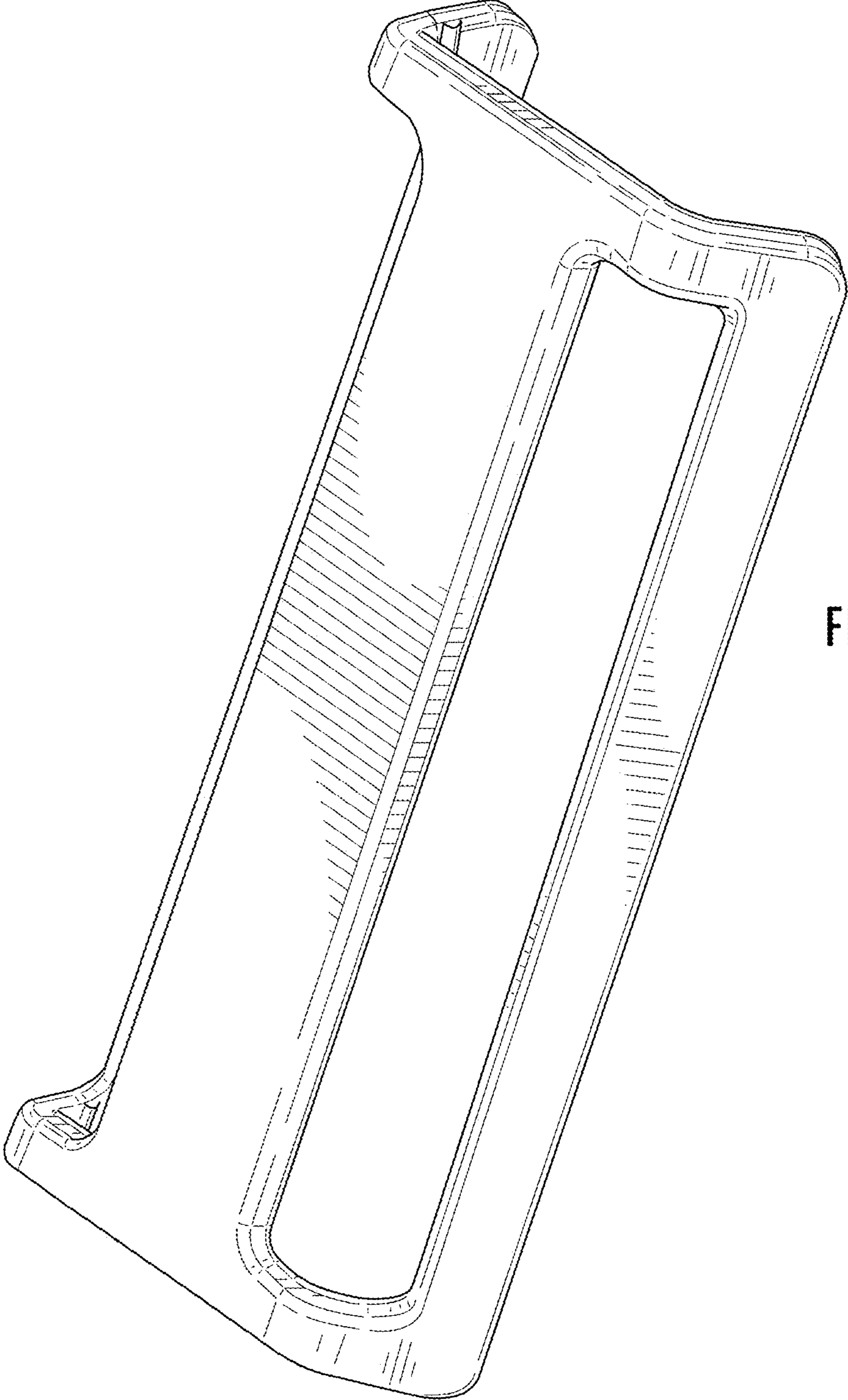

FIG. 1

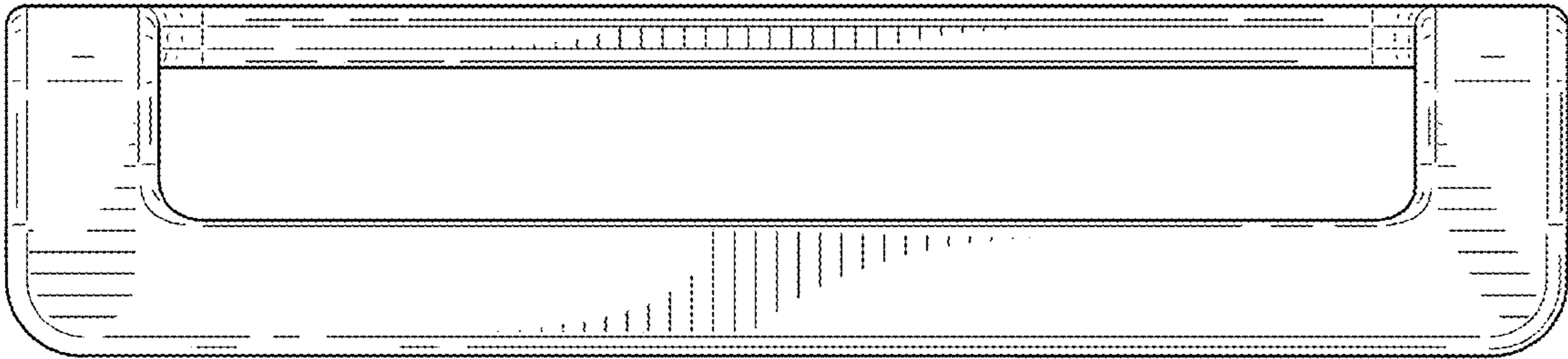

FIG. 2

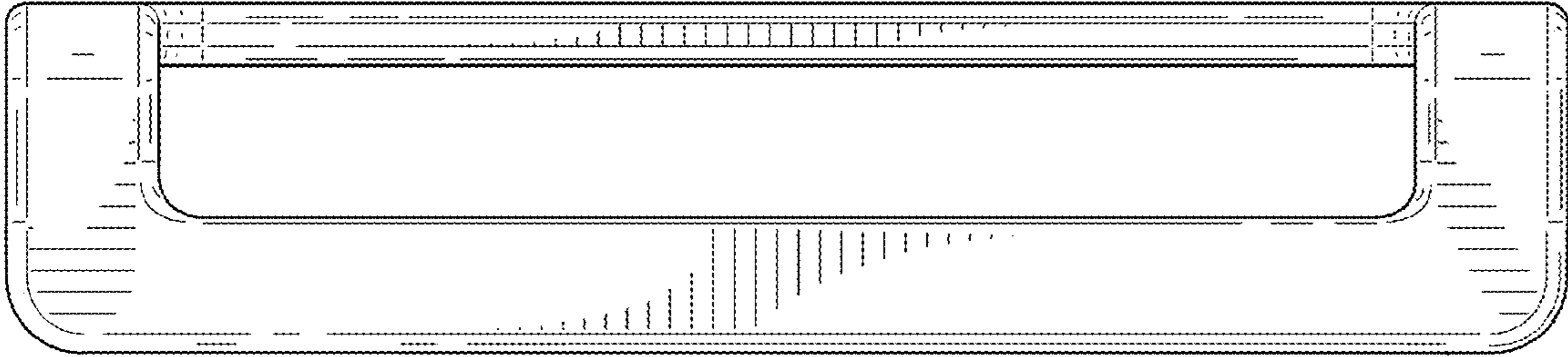

FIG. 3

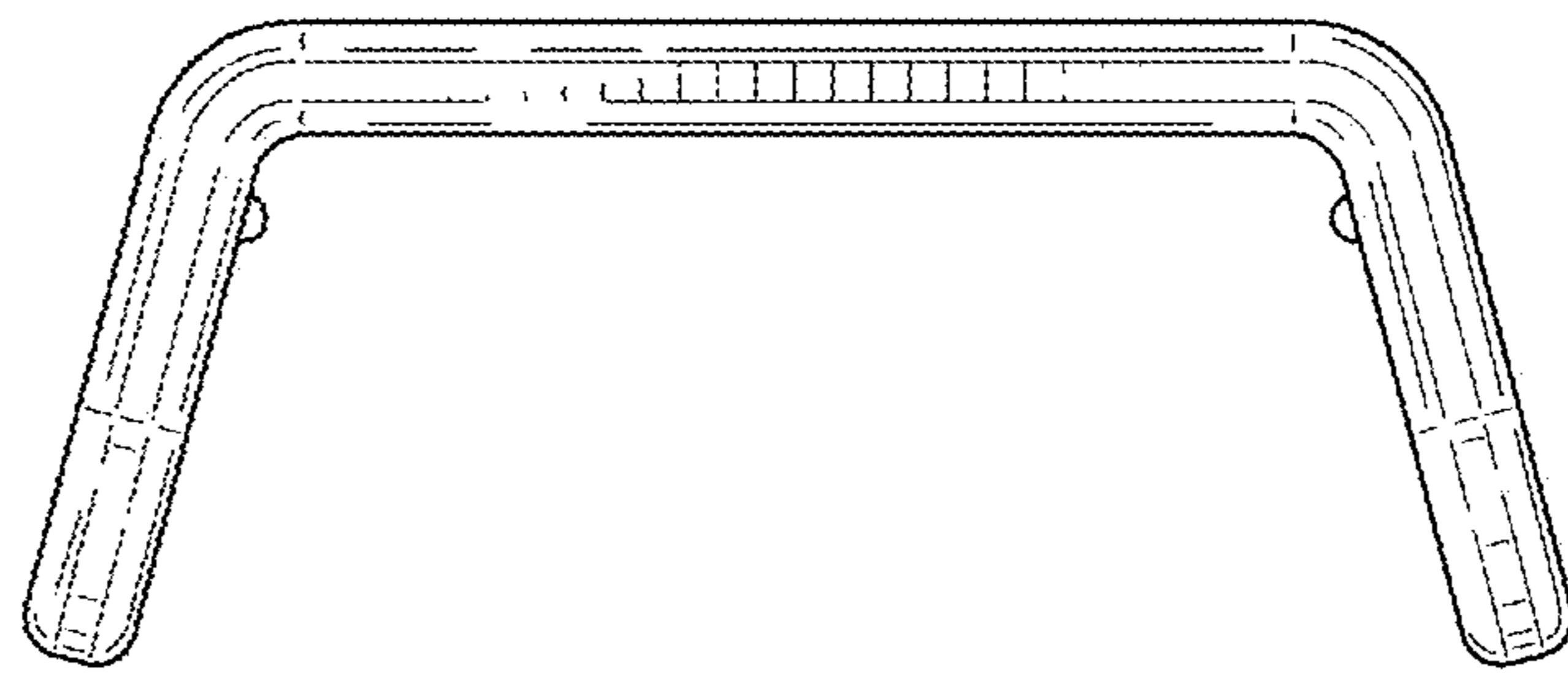

FIG. 4

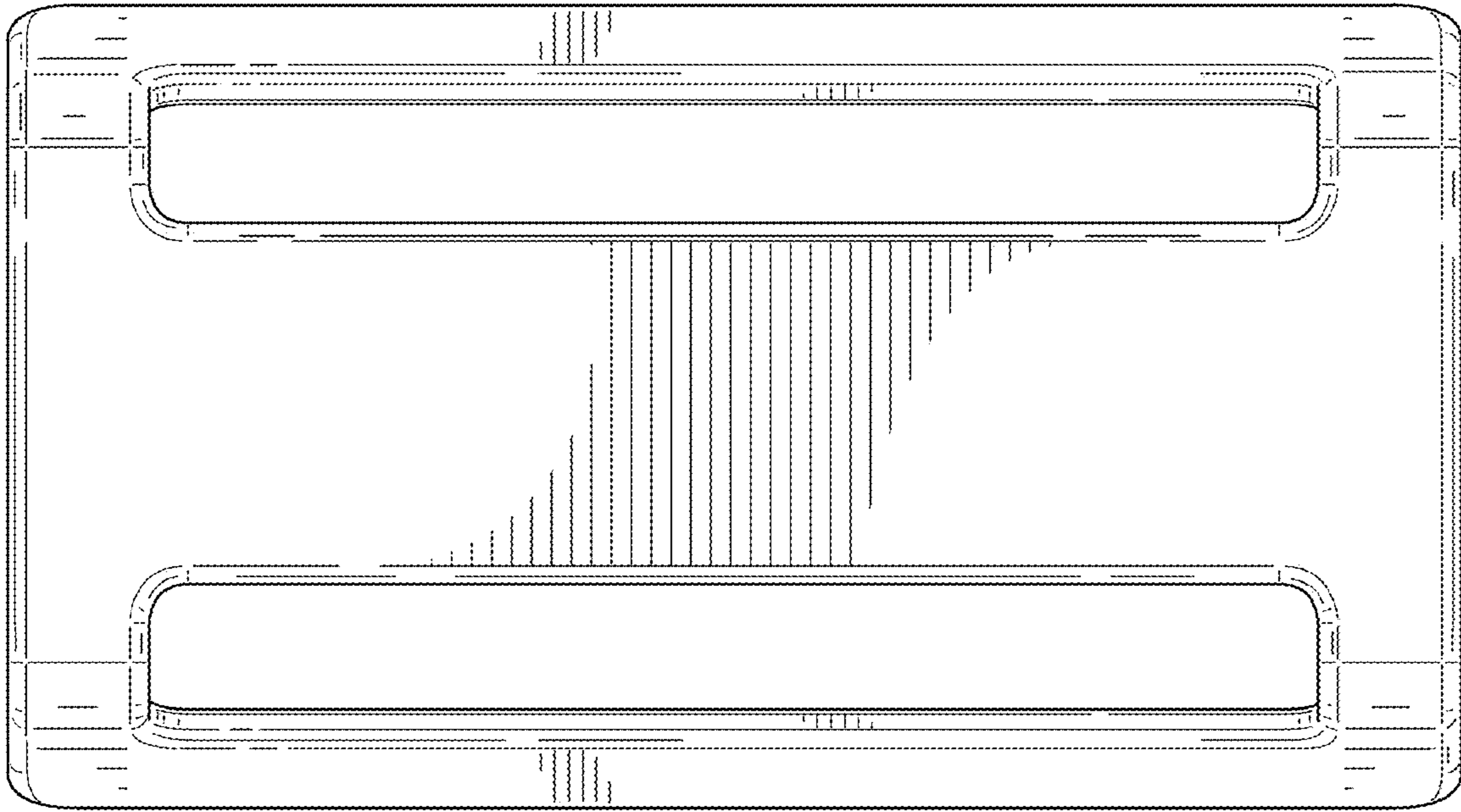

FIG. 5

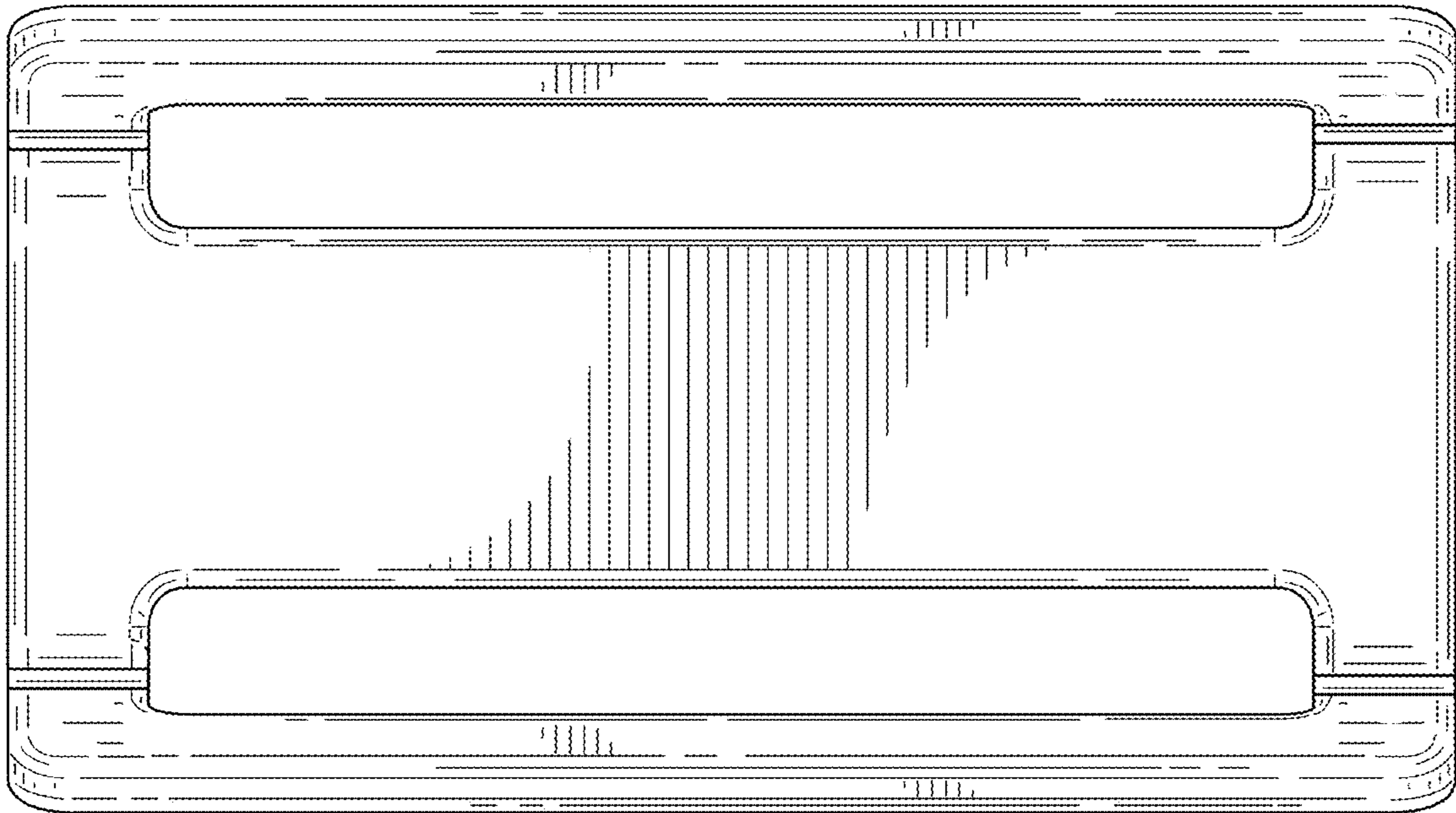

FIG. 6