



US00D952247S

(12) **United States Design Patent**
Gautier et al.

(10) **Patent No.:** **US D952,247 S**

(45) **Date of Patent:** **** May 17, 2022**

(54) **DEVICE FOR APPLYING COSMETIC PRODUCTS**

1/0223; B65D 1/0292; B65D 1/0207;
B65D 43/16; B65D 85/00

See application file for complete search history.

(71) Applicant: **PARFUMS CHRISTIAN DIOR**, Paris (FR)

(56) **References Cited**

(72) Inventors: **François Gautier**, Colombes (FR);
Clémence Dardenne, Paris (FR)

U.S. PATENT DOCUMENTS

(73) Assignee: **PARFUMS CHRISTIAN DIOR**, Paris (FR)

D708,783	S	*	7/2014	Kim	D28/7
D730,743	S	*	6/2015	Kim	D9/695
D830,627	S	*	10/2018	Duquet	D28/7
D849,555	S	*	5/2019	Jung	D9/723
D910,236	S	*	2/2021	Thorpe	D28/7
2016/0249726	A1	*	9/2016	Jung	B65D 41/165 401/261
2017/0143096	A1	*	5/2017	Zembrod	A45D 40/26
2017/0295905	A1	*	10/2017	Kim	B65D 41/005

(**) Term: **15 Years**

(21) Appl. No.: **35/511,381**

* cited by examiner

(22) Filed: **Dec. 2, 2020**

(80) **Hague Agreement Data**

Primary Examiner — Michael A. Pratt

Int. Filing Date: **Dec. 2, 2020**

(74) *Attorney, Agent, or Firm* — IpHorgan Ltd.

Int. Reg. No.: **DM/212542**

Int. Reg. Date: **Dec. 2, 2020**

Int. Reg. Pub. Date: **Feb. 12, 2021**

(57) **CLAIM**

The ornamental design for a device for applying cosmetic products, as shown and described.

(30) **Foreign Application Priority Data**

DESCRIPTION

Sep. 8, 2020 (EM) 008162945-0001

(51) **LOC (13) Cl.** **28-02**

(52) **U.S. Cl.**
USPC **D28/7**

(58) **Field of Classification Search**
USPC D28/4, 7; D9/723-727, 695, 697, 711,
D9/440, 442

CPC A45D 40/265; A45D 34/04; A45D
2200/1018; A45D 40/267; A45D 34/046;
A45D 2200/10; A45D 34/041; B65D

1. Device for applying cosmetic products
- 1.1 : Perspective
- 1.2 : Front
- 1.3 : Back
- 1.4 : Right
- 1.5 : Left
- 1.6 : Top
- 1.7 : Bottom

1 Claim, 7 Drawing Sheets

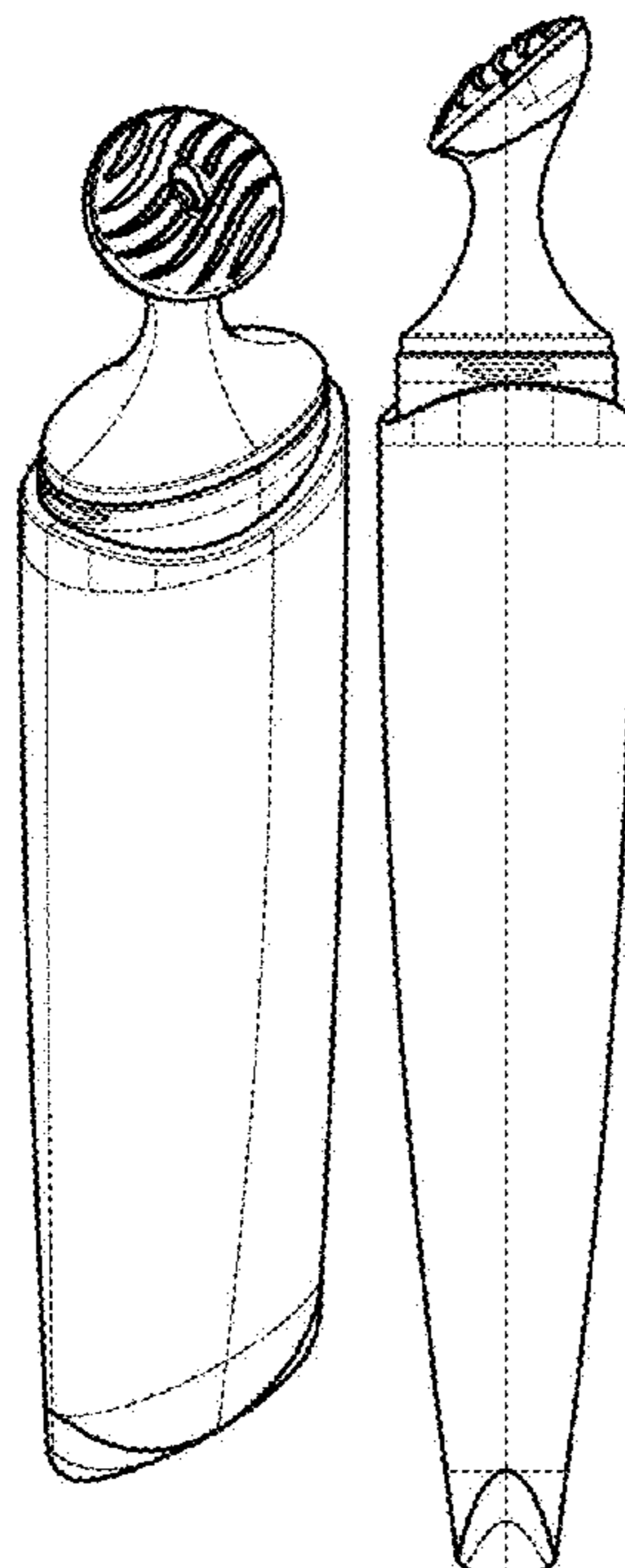

1.1

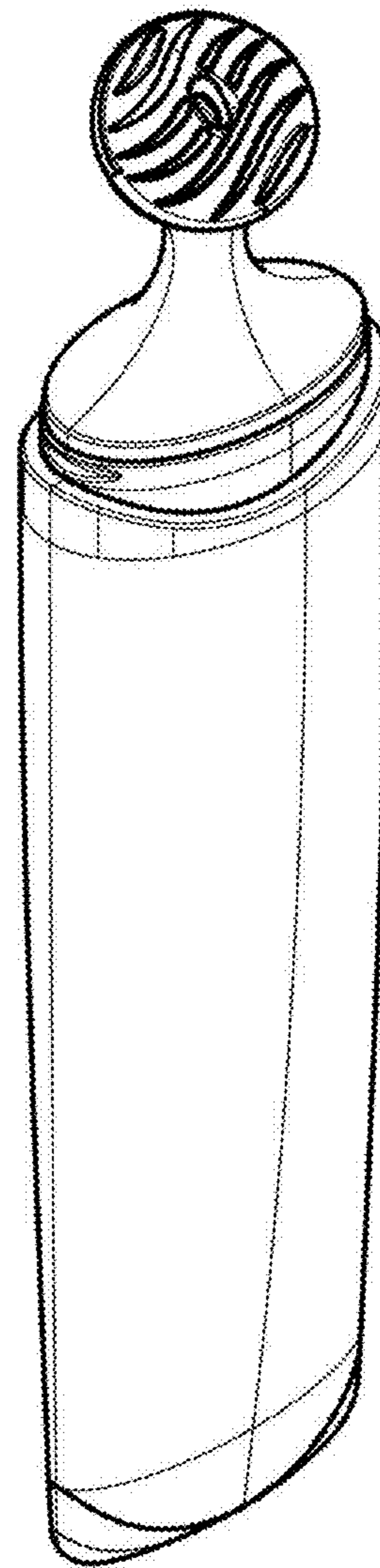

1.2

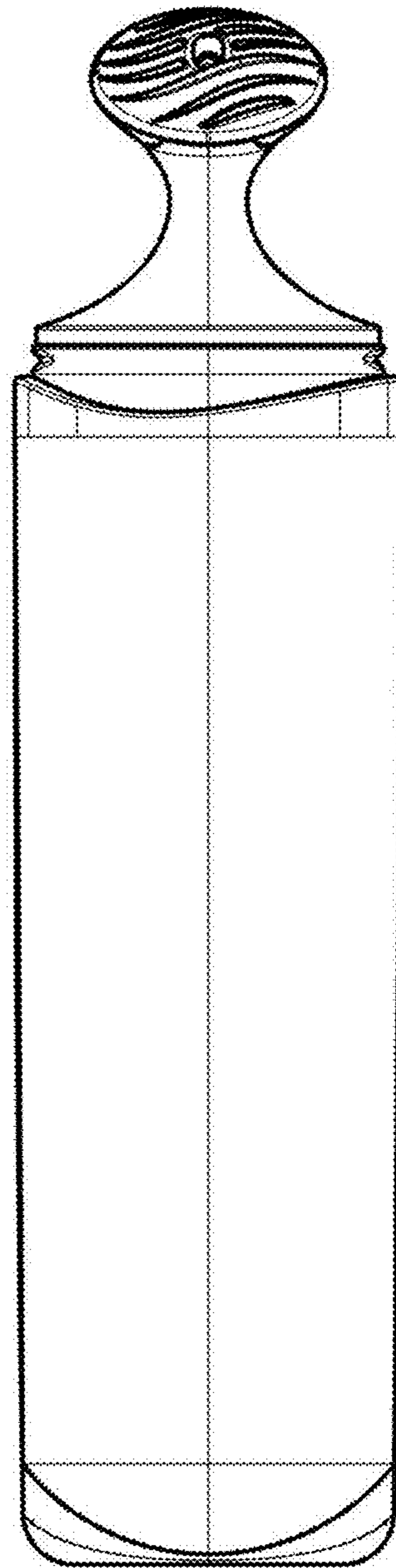

1.3

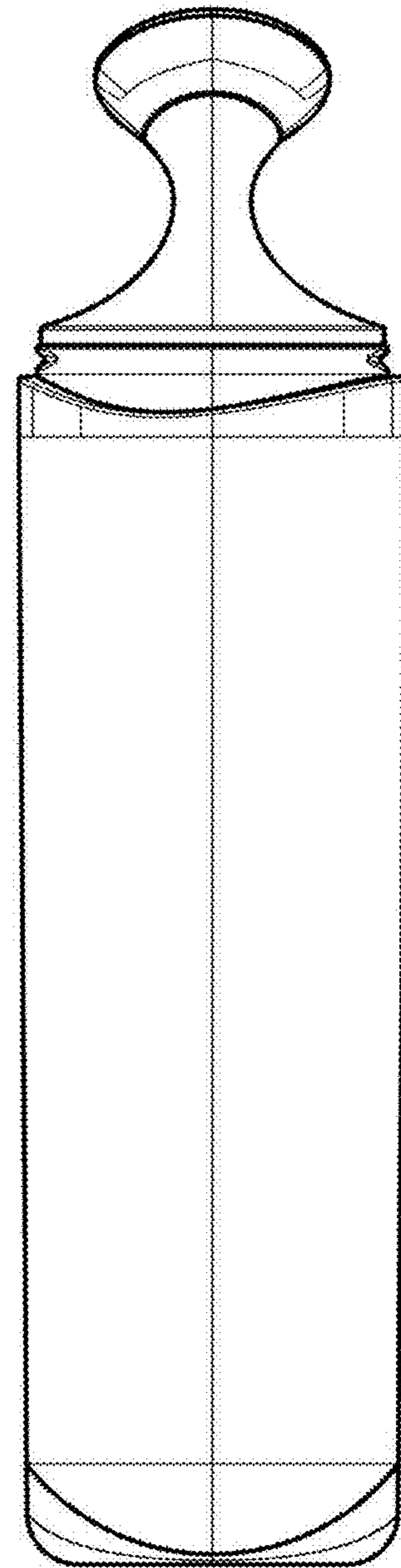

1.4

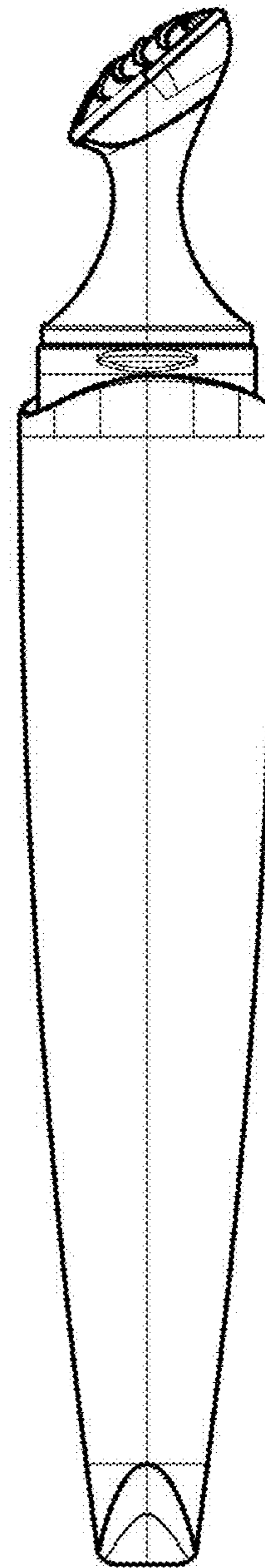

1.5

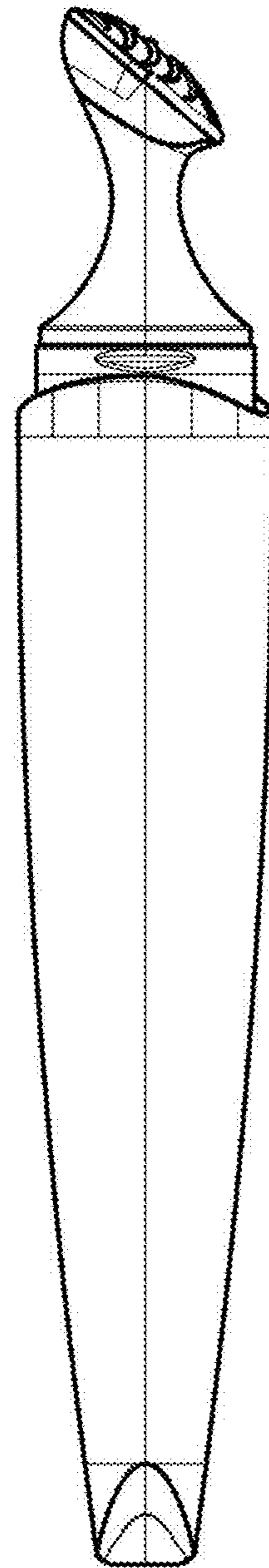

1.6

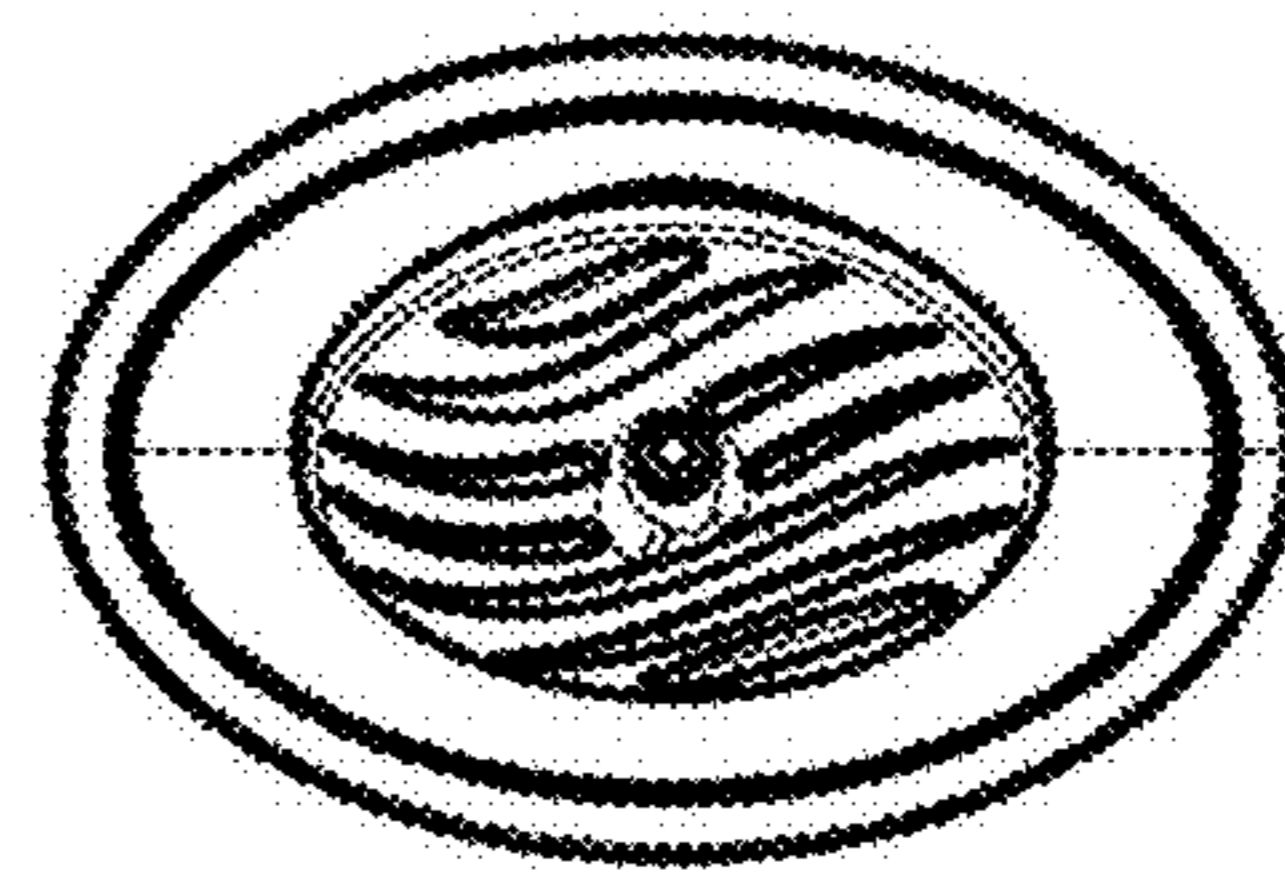

1.7

