



US00D952177S

(12) **United States Design Patent** (10) **Patent No.:** **US D952,177 S**  
**Jiang** (45) **Date of Patent:** **\*\* May 17, 2022**

(54) **SEX TOY**  
(71) Applicant: **SHENZHEN KOALA CROSS-BORDER E-COMMERCE CO., LTD.**, Shenzhen (CN)  
(72) Inventor: **Changbing Jiang**, Wugang (CN)  
(73) Assignee: **SHENZHEN KOALA CROSS-BORDER E-COMMERCE CO., LTD.**, Shenzhen (CN)  
(\*\*) Term: **15 Years**  
(21) Appl. No.: **29/787,077**  
(22) Filed: **Jun. 4, 2021**  
(51) **LOC (13) Cl.** ..... **28-03**  
(52) **U.S. Cl.**  
USPC ..... **D24/215**  
(58) **Field of Classification Search**  
USPC ..... D24/141, 190, 200, 211, 212, 213, 214, D24/215; D30/160  
CPC .. A61H 19/40; A61H 2205/087; A61H 19/34; A61H 21/00  
See application file for complete search history.

(56) **References Cited**  
U.S. PATENT DOCUMENTS  
D681,219 S \* 4/2013 Chen ..... D24/215  
D681,224 S \* 4/2013 Chen ..... D24/215  
D685,917 S \* 7/2013 Chen ..... D24/215  
D685,918 S \* 7/2013 Chen ..... D24/215  
D854,181 S \* 7/2019 Wei ..... D24/215  
D879,990 S \* 3/2020 Qiu ..... D24/215

D879,992 S \* 3/2020 Li ..... D24/215  
D882,109 S \* 4/2020 Qiu ..... D24/215  
D882,813 S \* 4/2020 Lee ..... D24/215  
D884,914 S \* 5/2020 Gao ..... D24/215  
D893,739 S \* 8/2020 Li ..... D24/215  
D908,909 S 1/2021 Huang  
D911,544 S 2/2021 Zhou  
D920,530 S \* 5/2021 Sedic ..... D24/215  
D925,757 S \* 7/2021 Zhou ..... D24/215  
D936,853 S \* 11/2021 Dumler ..... D24/215  
D938,606 S \* 12/2021 Dumler ..... D24/215  
D941,483 S \* 1/2022 Lee ..... D24/215  
2017/0027809 A1\* 2/2017 Lenke ..... A61H 23/0263  
2018/0140504 A1\* 5/2018 Chang ..... A61H 99/00

\* cited by examiner

*Primary Examiner* — Michael A Maharajh

(57) **CLAIM**

The ornamental design for a sex toy, as shown and described.

**DESCRIPTION**

FIG. 1 is a perspective view of a sex toy showing my new design;  
FIG. 2 is another perspective view thereof;  
FIG. 3 is a front elevational view thereof;  
FIG. 4 is a rear elevational view thereof;  
FIG. 5 is a left side elevational view thereof;  
FIG. 6 is a right side elevational view thereof;  
FIG. 7 is a top plan view thereof; and,  
FIG. 8 is a bottom plan view thereof.  
The broken lines in the drawings depict portions of the sex toy that form no part of the claimed design.

**1 Claim, 8 Drawing Sheets**

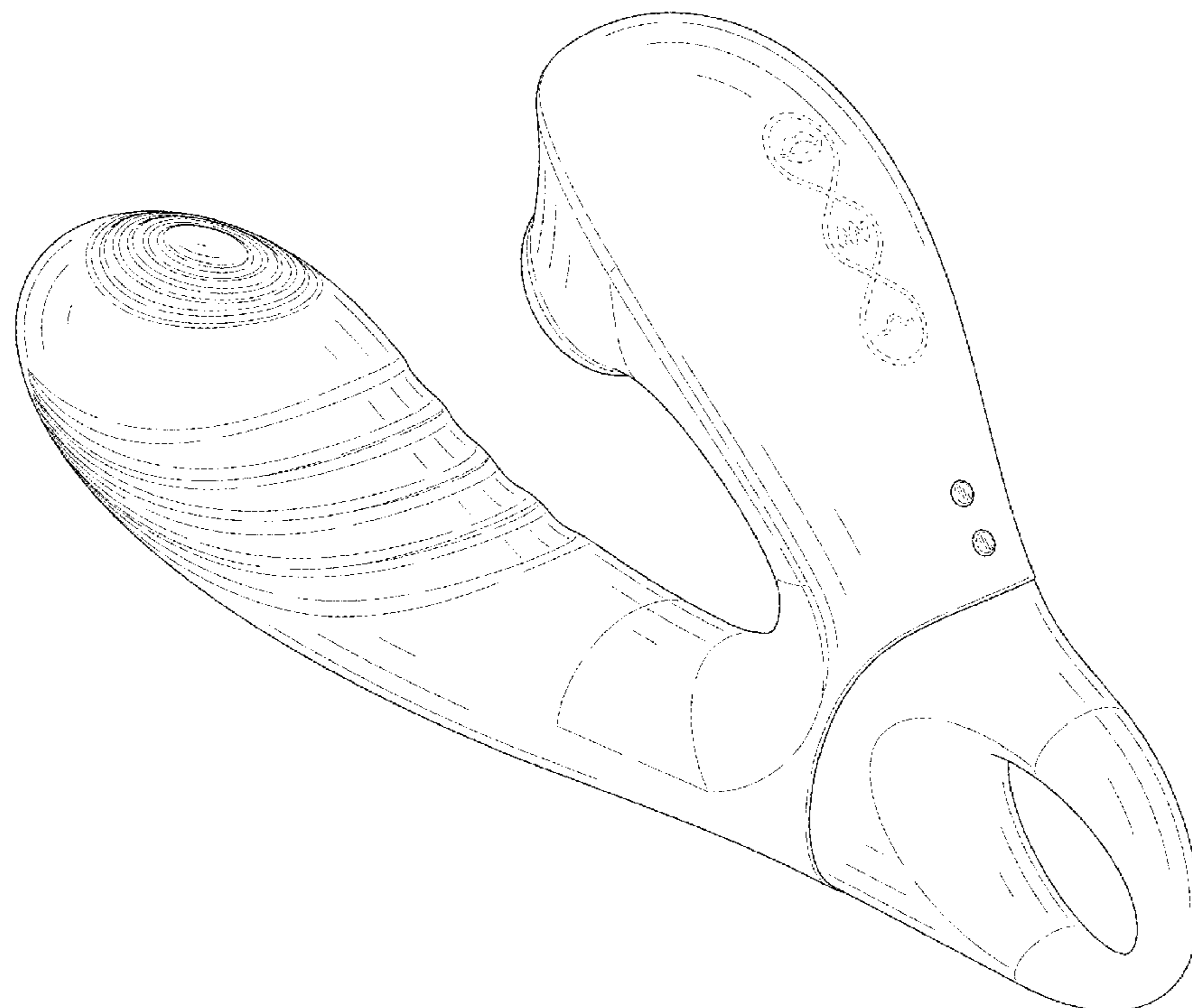

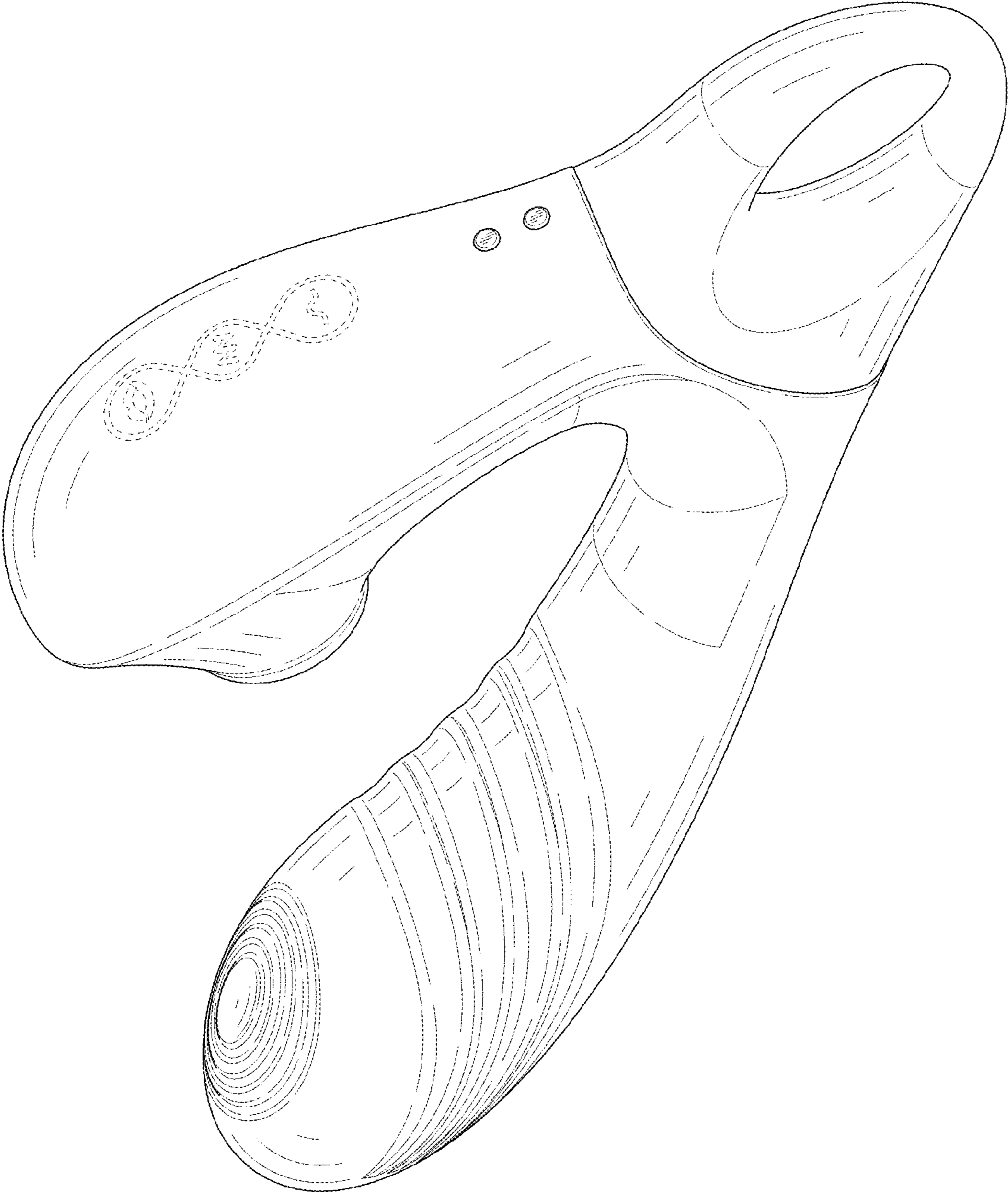

FIG. 1

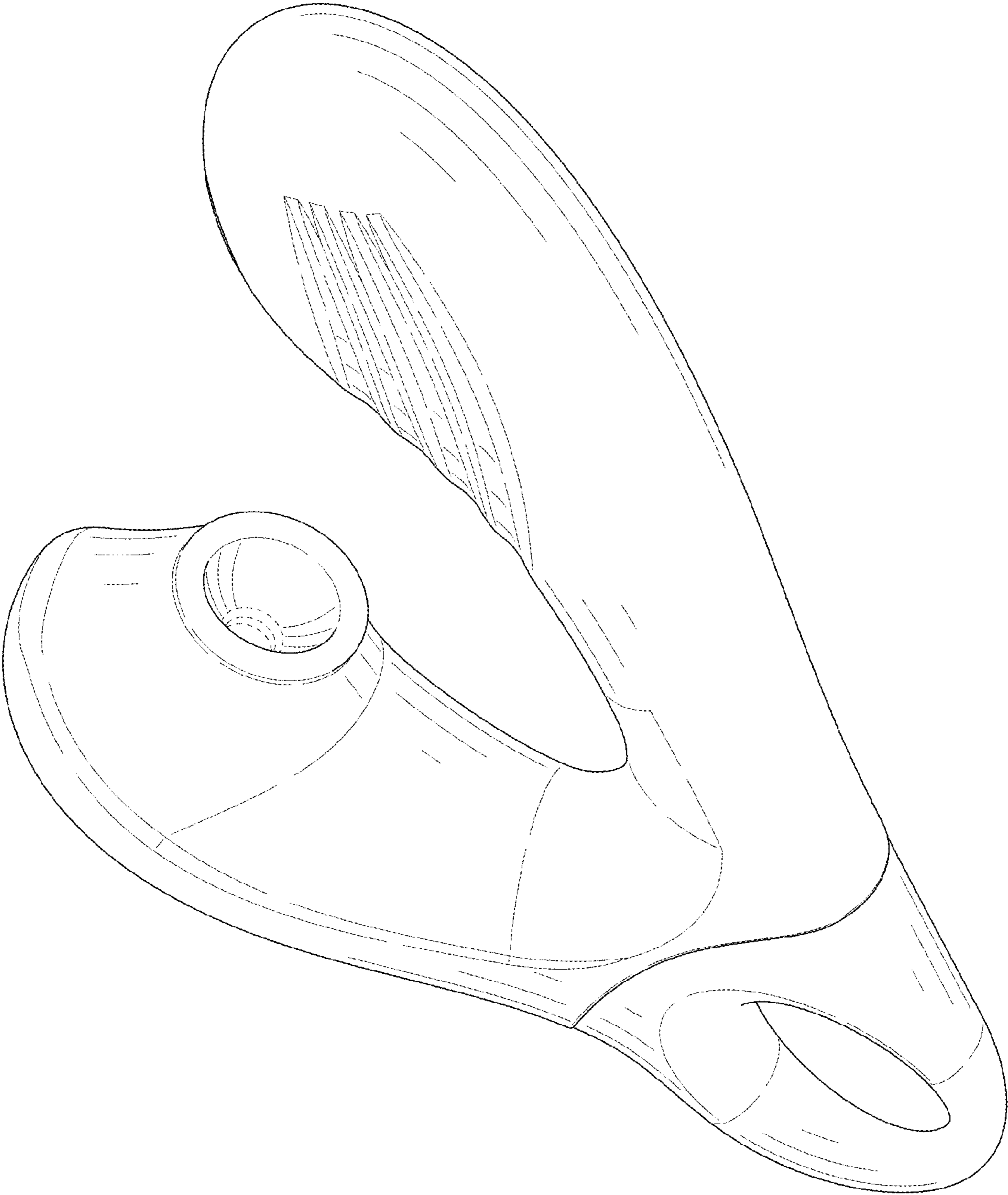

FIG. 2

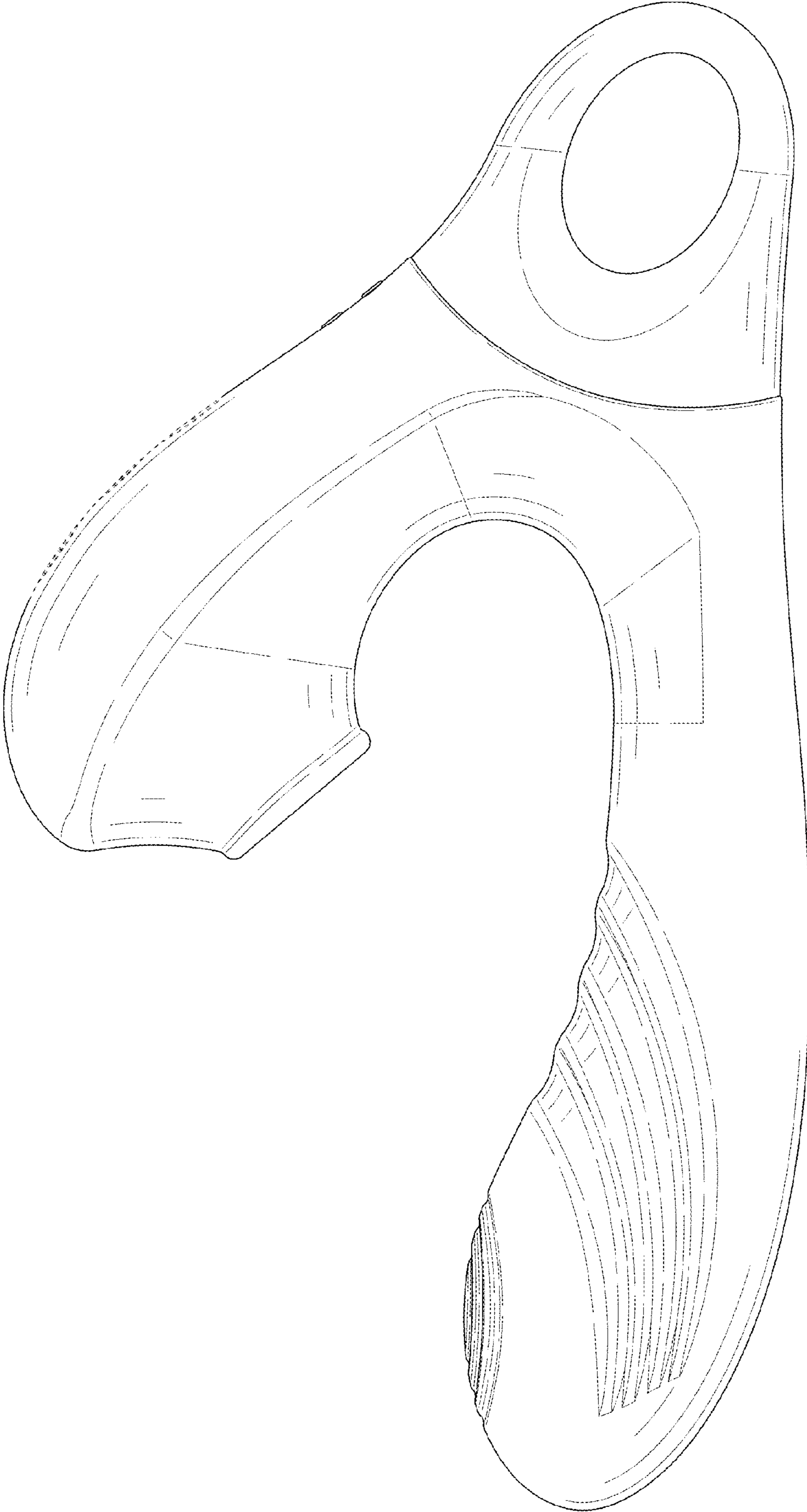

FIG. 3

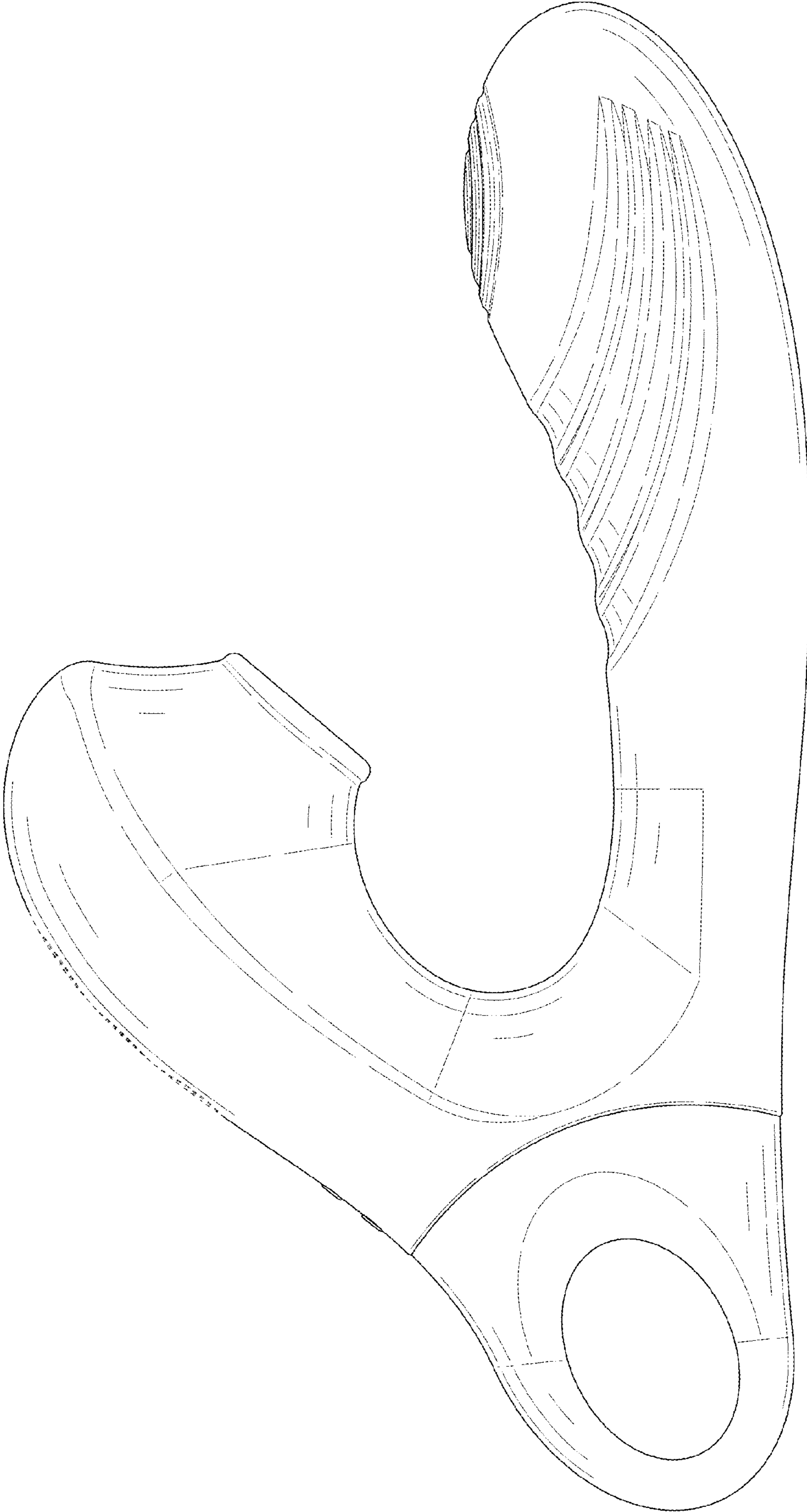

FIG. 4

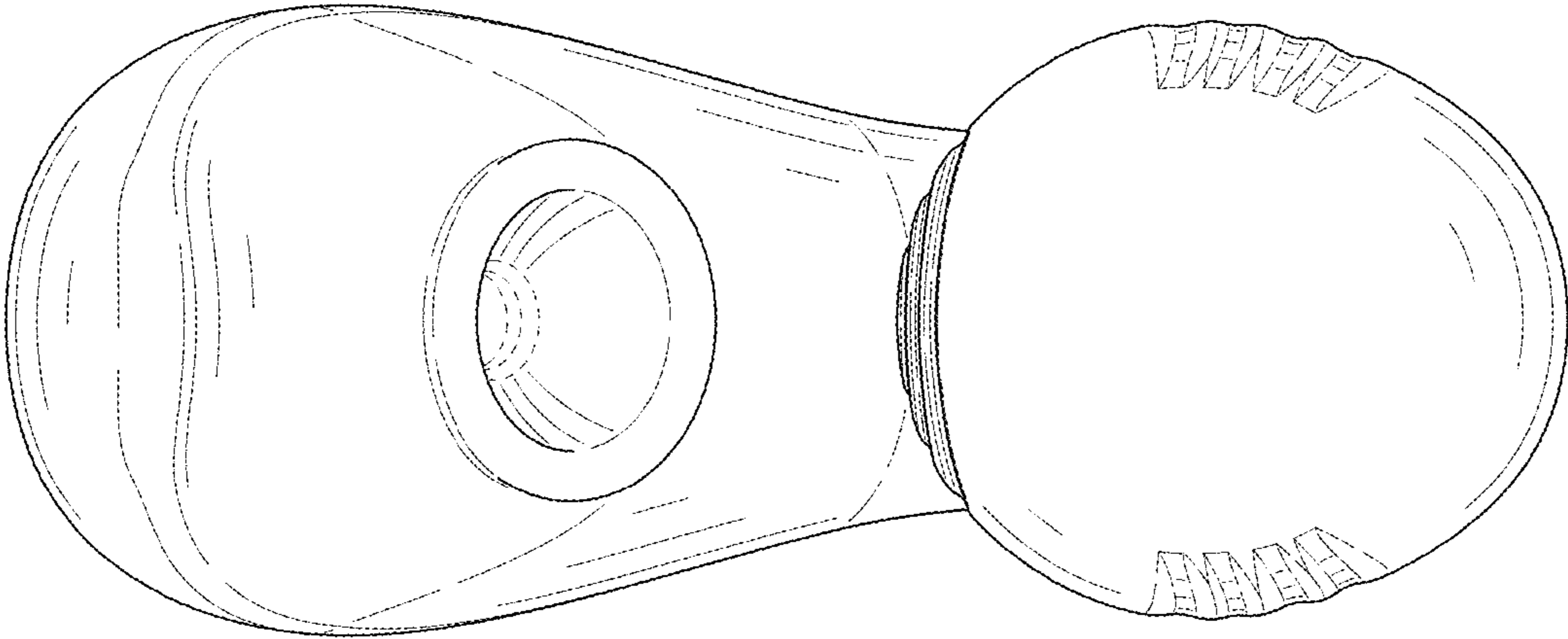

FIG. 5

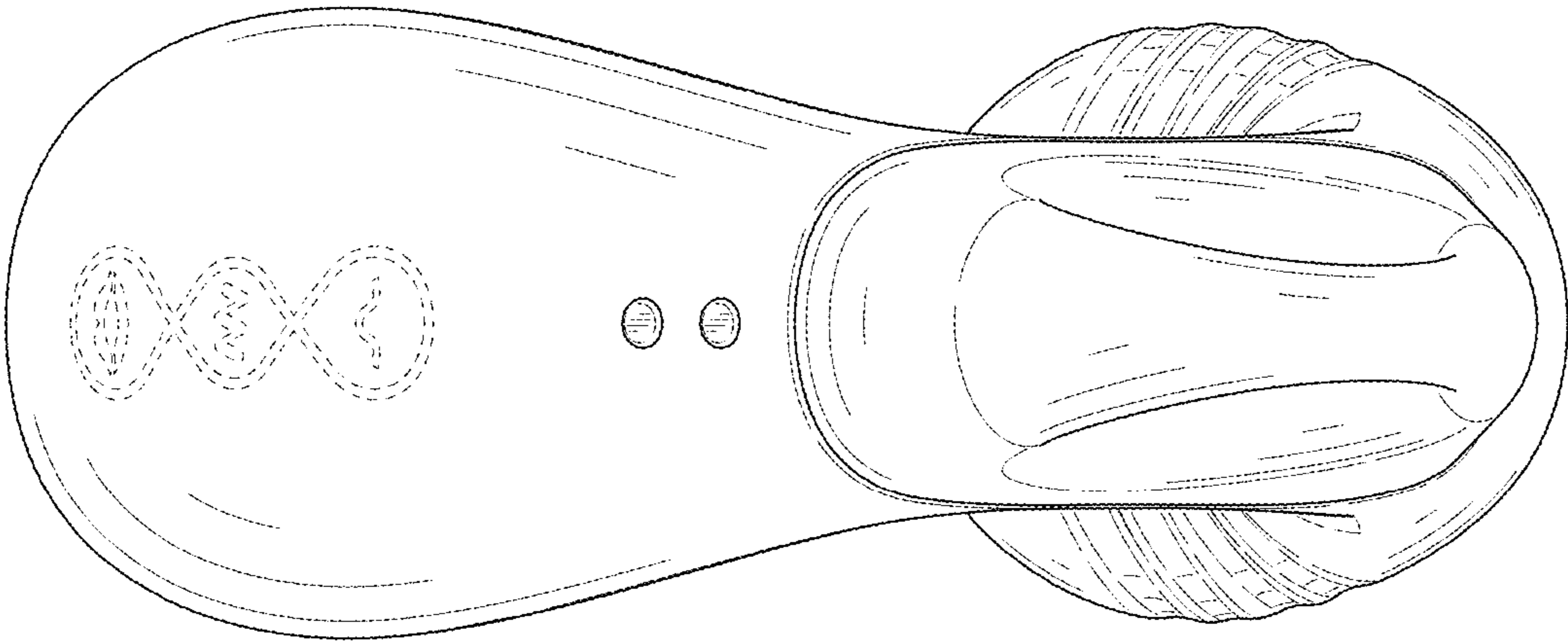

FIG. 6

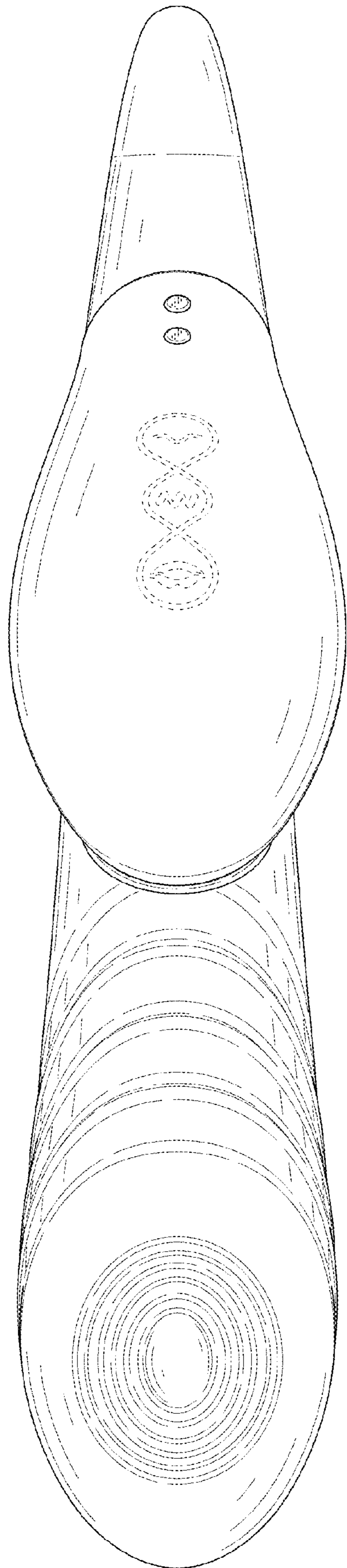

FIG. 7



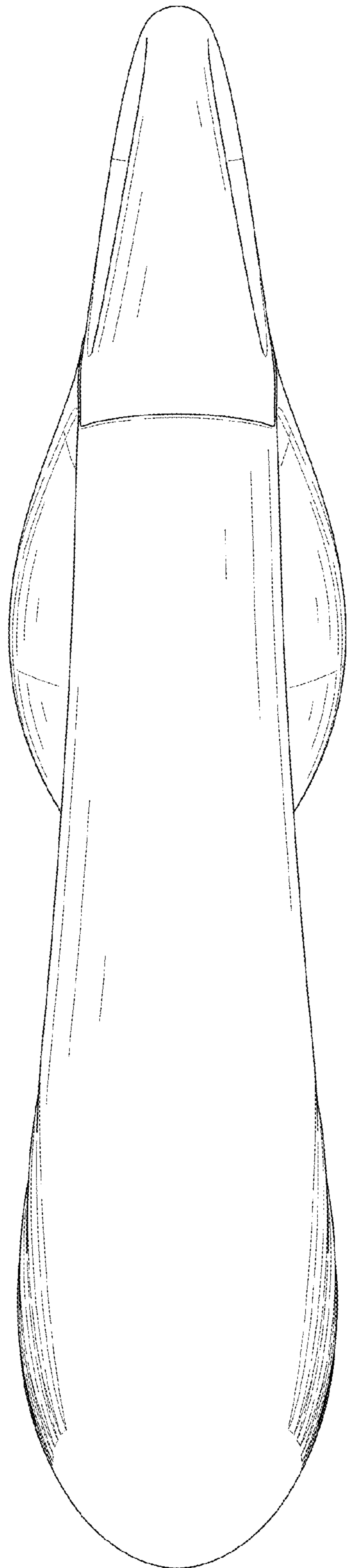

FIG. 8