



US00D952093S

(12) **United States Design Patent** (10) **Patent No.:** **US D952,093 S**
Kielsmeier et al. (45) **Date of Patent:** **** May 17, 2022**

(54) **AMMUNITION MAGAZINE**

- (71) Applicant: **Magpul Industries Corp.**, Austin, TX (US)
- (72) Inventors: **Nicholas Kielsmeier**, Denver, CO (US); **Michael T. Mayberry**, Denver, CO (US); **Cristopher McRae**, Austin, TX (US)
- (73) Assignee: **Magpul Industries Corp.**, Austin, TX (US)

(**) Term: **15 Years**

(21) Appl. No.: **29/676,808**

(22) Filed: **Jan. 15, 2019**

(51) **LOC (13) Cl.** **22-01**

(52) **U.S. Cl.**
USPC **D22/108**

(58) **Field of Classification Search**
USPC D22/100, 101, 102, 103, 104, 108–111;
D21/574
CPC F41A 11/00; F41A 11/02
See application file for complete search history.

(56) **References Cited**

U.S. PATENT DOCUMENTS

D616,057 S *	5/2010	Fitzpatrick	D22/108
D620,544 S *	7/2010	Fitzpatrick	D22/108
D620,545 S *	7/2010	Fitzpatrick	D22/108
D633,164 S *	2/2011	Fitzpatrick	D22/108
D680,613 S *	4/2013	Fitzpatrick	D22/108
D681,151 S *	4/2013	Fitzpatrick	D22/108
D688,766 S *	8/2013	Fitzpatrick	D22/108
D691,233 S *	10/2013	Bennett	D22/108
D695,378 S *	12/2013	Fitzpatrick	D22/108
D705,886 S *	5/2014	Kielsmeier	D22/108
D707,783 S *	6/2014	Kielsmeier	D22/108
D710,479 S *	8/2014	Nakayama	D22/108
D712,500 S *	9/2014	Nakayama	D22/108

(Continued)

OTHER PUBLICATIONS

Magpul Website, pmag-35-ev9-cz-scorpion, Earliest date on Internet Archive Jul. 9, 2021, [site visited Aug. 26, 2021], Available on the Internet URL https://web.archive.org/web/20210709224314/https://magpul.com/firearm-accessories/pmags/cz-scorpionr-evo-3/pmag-35-ev9-cz-scorpion.html?mp_global_color=118 (Year: 2021).*

(Continued)

Primary Examiner — S. Bryan Reinholdt, Jr.

(74) *Attorney, Agent, or Firm* — Neugeboren O'Dowd PC

(57) **CLAIM**

The ornamental design for an ammunition magazine, as shown and described.

DESCRIPTION

FIG. 1 is a right, rear, top perspective view of the ammunition magazine;
FIG. 2 is a right side elevation view of the ammunition magazine in FIG. 1;
FIG. 3 is a left side elevation view of the ammunition magazine in FIG. 1;
FIG. 4 is a front elevation view of the ammunition magazine in FIG. 1;
FIG. 5 is a rear elevation view of the ammunition magazine in FIG. 1;
FIG. 6 is a top view of the ammunition magazine in FIG. 1;
and,
FIG. 7 is a bottom view of the ammunition magazine in FIG. 1.

The shade lines in the Figures show contour and not surface ornamentation.

The evenly spaced broken lines and the areas within them in the Figures depict portions of the ammunition magazine that form no part of the claimed design. The dot-dash-dot broken lines depict the boundaries to the claim and form no part thereof.

1 Claim, 7 Drawing Sheets

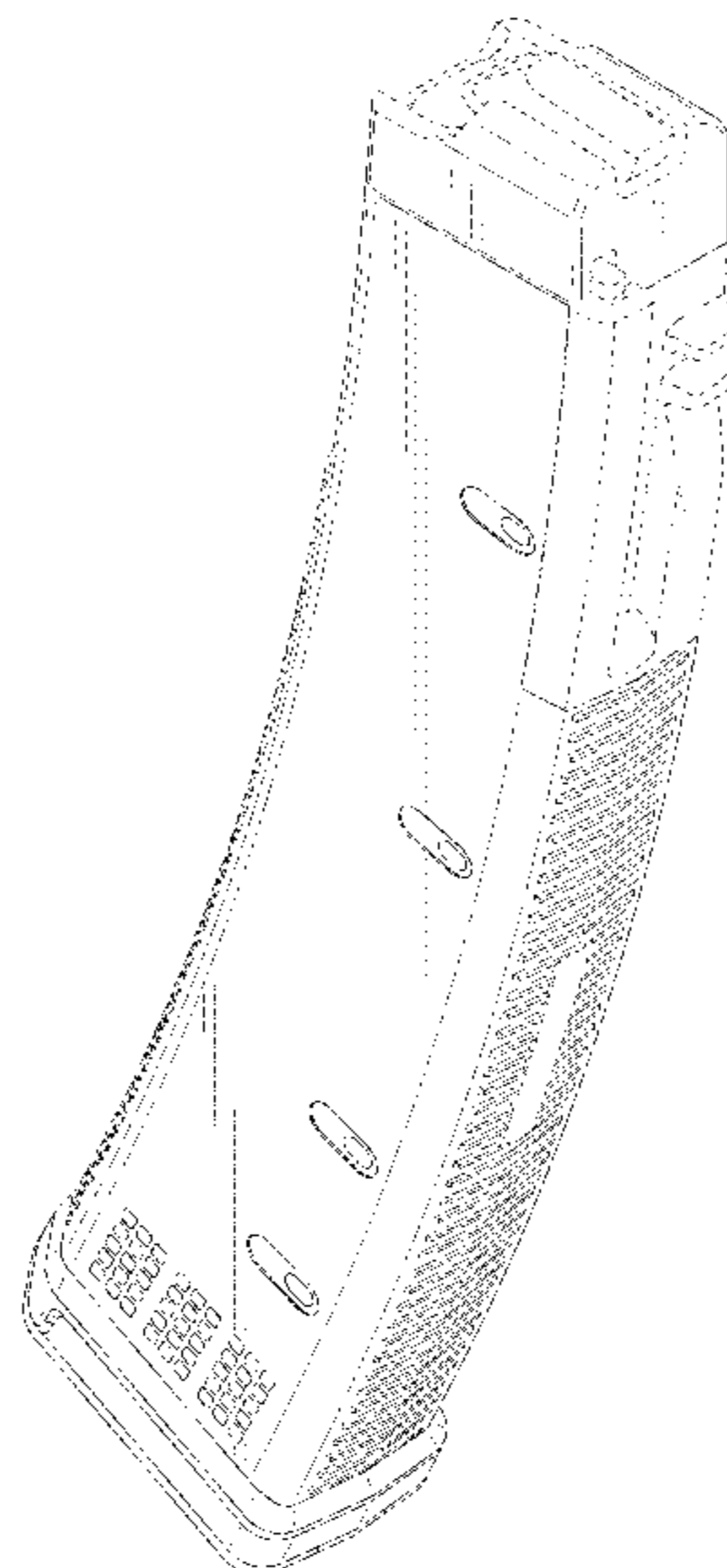

(56)

References Cited

U.S. PATENT DOCUMENTS

D736,337	S *	8/2015	Kielsmeier	D22/108
D755,336	S *	5/2016	Nakayama	D22/108
9,347,720	B2 *	5/2016	Fitzpatrick	F41A 9/64
D765,812	S *	9/2016	Kielsmeier	D22/108
D804,603	S *	12/2017	Kielsmeier	D22/108
D810,223	S *	2/2018	Kielsmeier	D22/108
D821,533	S *	6/2018	Nuss	D22/108
10,281,226	B2 *	5/2019	Liptak	F41A 9/65
D877,265	S *	3/2020	Hu	D21/573
10,724,824	B1 *	7/2020	Lister	F41C 23/12
2013/0180146	A1 *	7/2013	Fitzpatrick	F41A 9/64
					42/50

OTHER PUBLICATIONS

YouTube website, MagPul PMAG EV9 for CZ Scorpion Evo 3—Tabletop first look, Published Oct. 19, 2019, [site visited Aug.

26, 2021], Available on the Internet URL <https://www.youtube.com/watch?v=jlwtY0M1HNg> (Year: 2019).*

Arms Rock website, Shotshow CZ Scorpion EVO3, Published Jan. 27, 2019, [site visited Aug. 26, 2021], Available on the Internet URL <http://www.armsrock.com/topic/647> (Year: 2019).*

Surplus Ammo.com, Magpul PMAG EV9 CZ Scorpion EVO-3, Publication date unknown, [site visited Aug. 26, 2021], Available on the Internet URL <https://www.surplusammo.com/products/magpul-pmag-ev9-cz-scorpion-evo-3-9mm-luger-magazine-35-rounds-single-mag.html> (Year: 2021).*

Palmetto State Armory, “PSA AK-V 9X19MM 35 Round Patterned Magazine—5165448274”, “Retrieved from <https://palmettostatearmory.com/psa-ak-v-9x19mm-35-round-u9-pattened-magazine-5165448274.html>”, Known to exist as early as Dec. 5, 2018, p. 1.

CZ-USA, “Scorpion Evo 3 S1 Pistol Magazines”, “Retrieved from <https://shop.cz-usa.com/cz-products/scorpion-evo-3-s1-pistol/magazines>”, Known to exist as early as Dec. 5, 2018, p. 1.

* cited by examiner

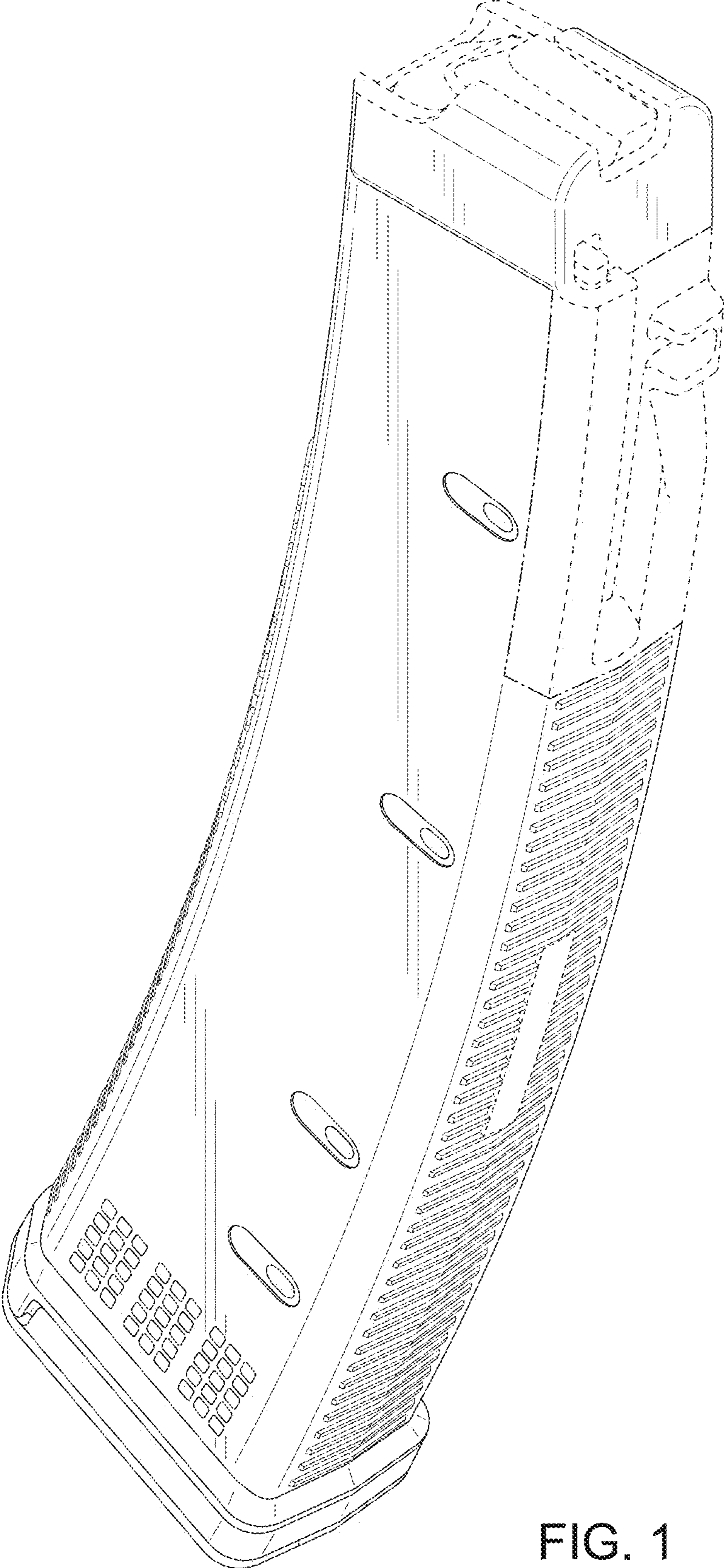

FIG. 1

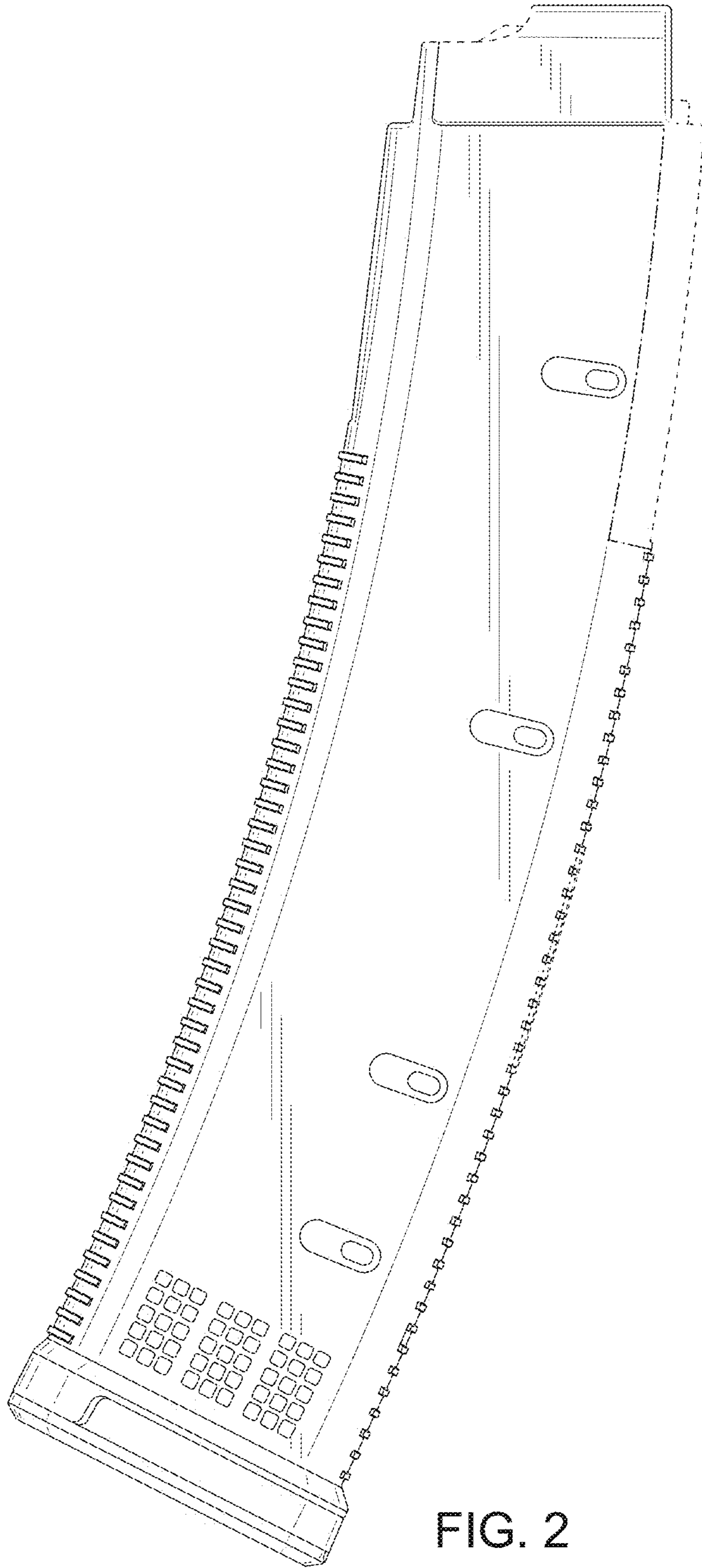

FIG. 2

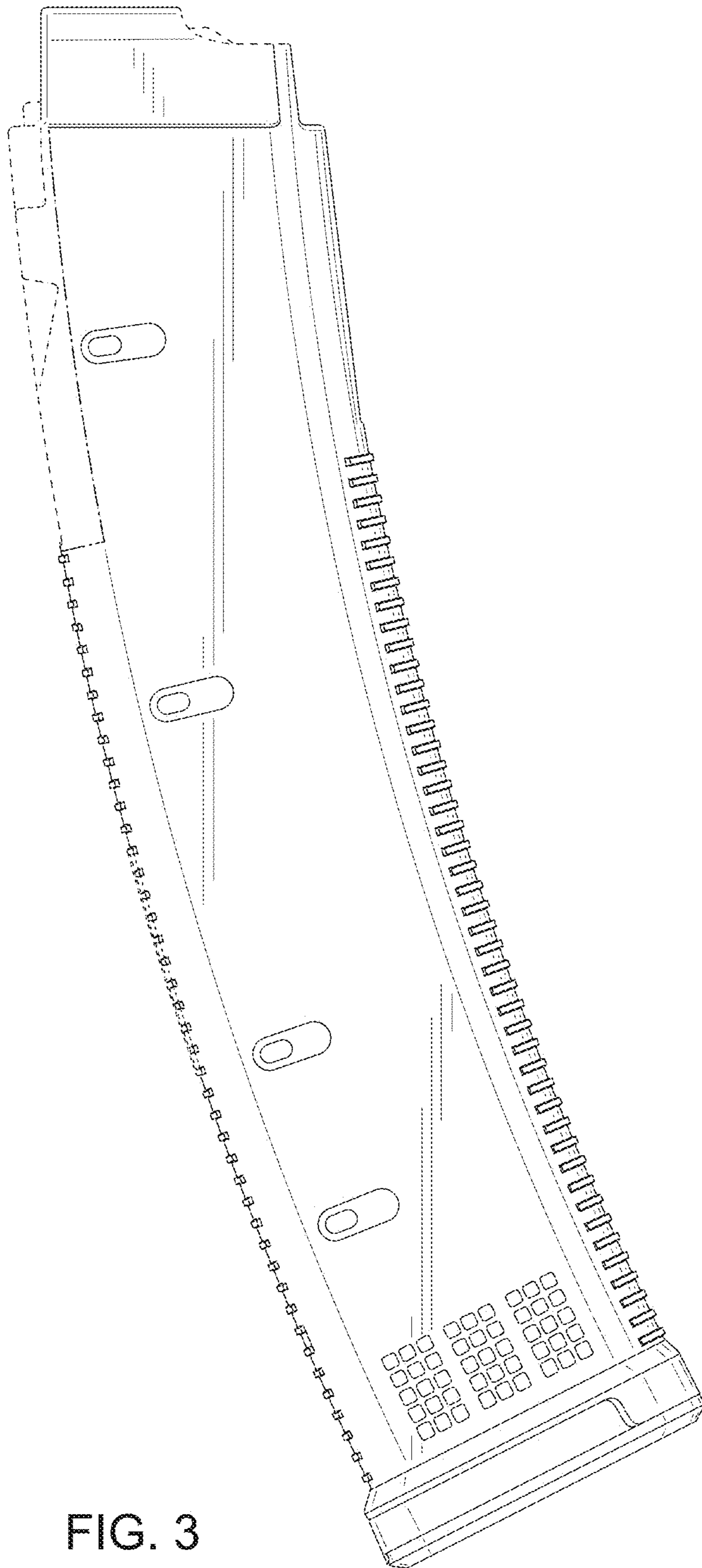

FIG. 3

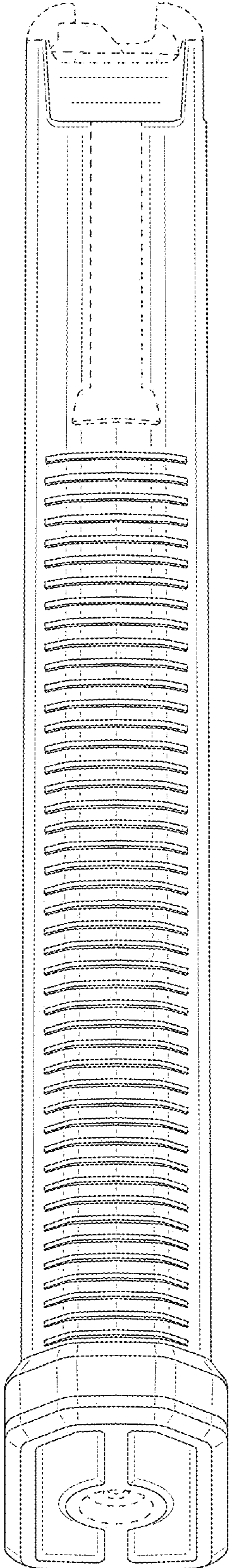

FIG. 4

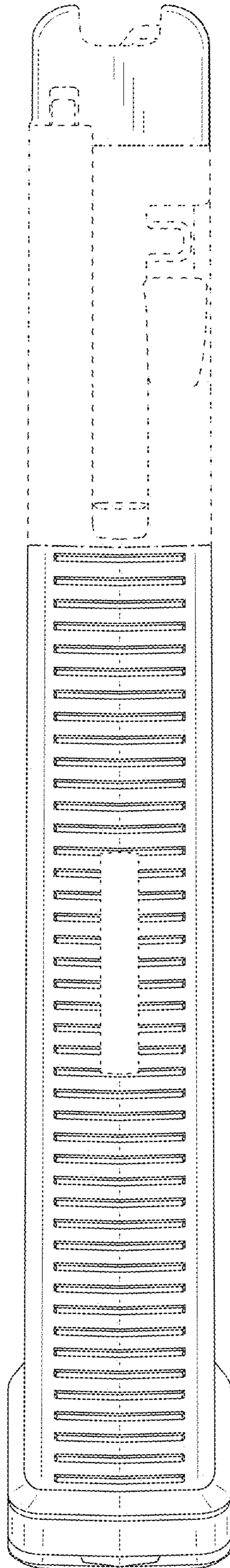

FIG. 5

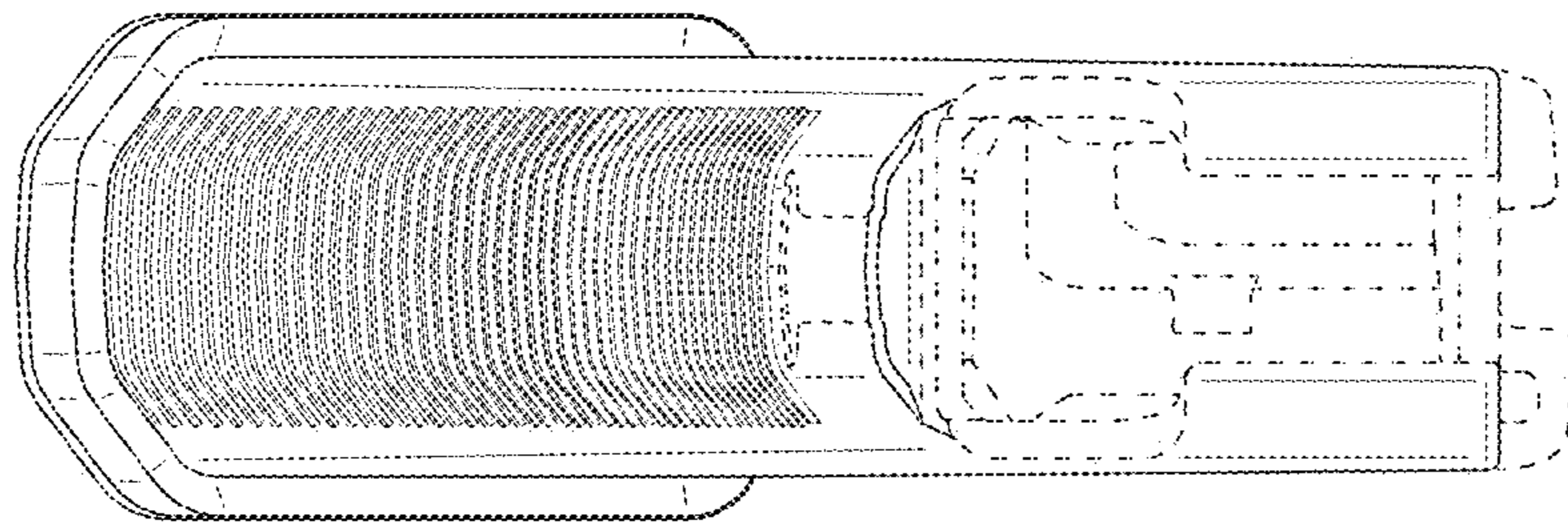

FIG. 6

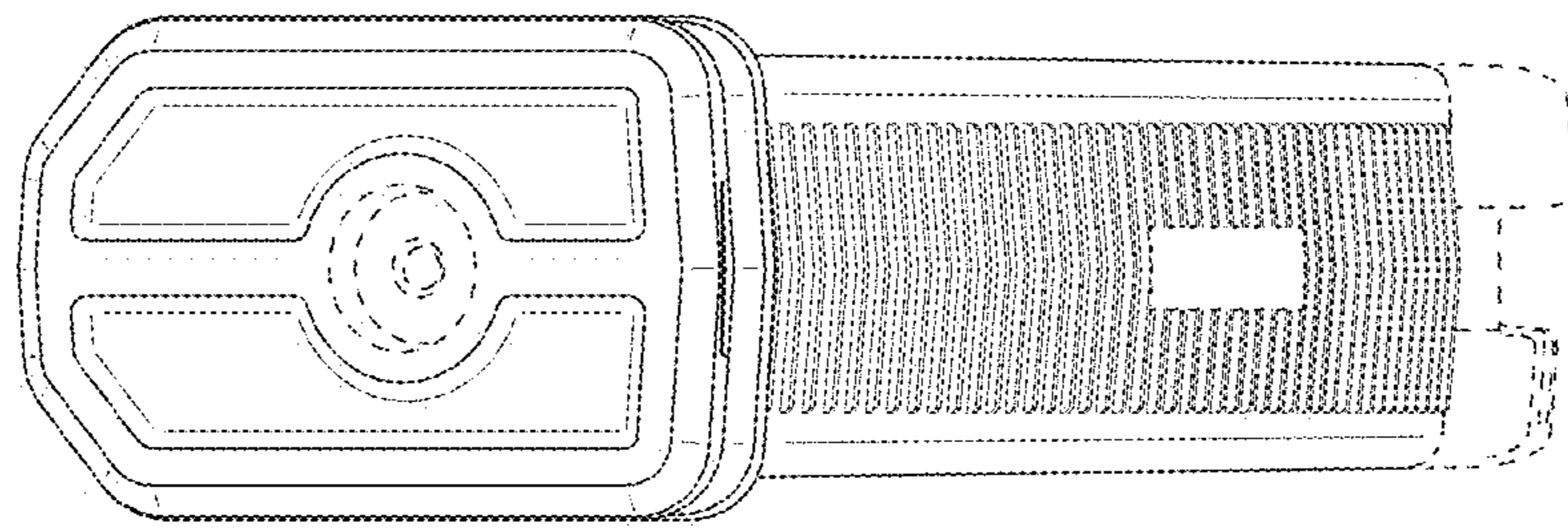

FIG. 7