



US00D952059S

(12) **United States Design Patent**
Zheng

(10) **Patent No.:** **US D952,059 S**

(45) **Date of Patent:** **** May 17, 2022**

- (54) **TOY GUN**
- (71) Applicant: **SHANTOU QUANSHENG TOY FACTORY**, Shantou (CN)
- (72) Inventor: **Wenjie Zheng**, Chaozhou (CN)
- (73) Assignee: **SHANTOU QUANSHENG TOY FACTORY**, Shantou (CN)
- (**) Term: **15 Years**
- (21) Appl. No.: **29/749,588**
- (22) Filed: **Sep. 8, 2020**
- (51) **LOC (13) Cl.** **21-01**
- (52) **U.S. Cl.**
USPC **D21/573**
- (58) **Field of Classification Search**
USPC D21/333, 570, 572-575; D14/418;
D22/100, 103
CPC F41B 7/00; F41B 7/003; F41B 7/08; F41B
9/00; F41B 9/0078; F41B 9/0081; F41B
11/89; A63H 5/04
See application file for complete search history.

- D639,352 S * 6/2011 Chan D21/572
- 8,118,637 B2 * 2/2012 De La Torre F41B 7/003
446/473
- D847,913 S * 5/2019 Patel D21/574
- D903,789 S * 12/2020 Zheng D21/572
- 2010/0041310 A1 * 2/2010 Torre F41B 7/08
446/473
- 2011/0186595 A1 * 8/2011 Garces F41B 9/00
222/79
- 2019/0113301 A1 * 4/2019 Ma F41B 9/0071
- 2019/0195592 A1 * 6/2019 Chia F41B 4/00
- 2019/0195593 A1 * 6/2019 Chia F41A 9/01

* cited by examiner

Primary Examiner — Cynthia M. Chin

(57) **CLAIM**

The ornamental design for a toy gun, as shown and described.

DESCRIPTION

FIG. 1 is a perspective view of a toy gun showing my new design;
 FIG. 2 is another perspective view thereof;
 FIG. 3 is a front elevational view thereof;
 FIG. 4 is a rear elevational view thereof;
 FIG. 5 is a left side elevational view thereof;
 FIG. 6 is a right side elevational view thereof;
 FIG. 7 is a top plan view thereof; and,
 FIG. 8 is a bottom plan view thereof.
 The broken lines in the drawings depict portions of the toy gun that form no part of the claimed design.

1 Claim, 8 Drawing Sheets

- (56) **References Cited**
U.S. PATENT DOCUMENTS
- D344,556 S * 2/1994 Liu D21/572
- D354,997 S * 1/1995 Arad D21/574
- D449,659 S * 10/2001 Hornsby D21/574
- D454,926 S * 3/2002 Hornsby D21/574

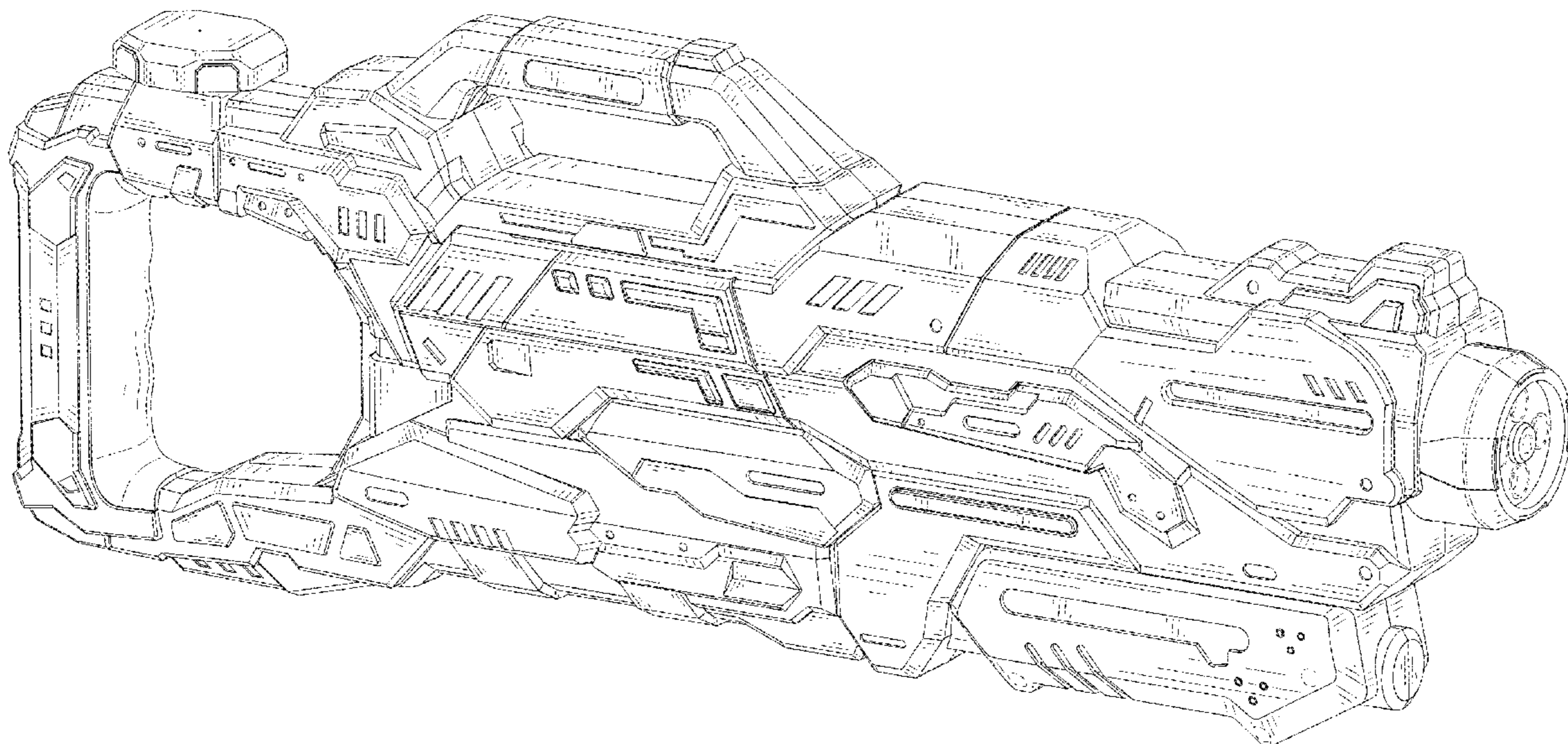

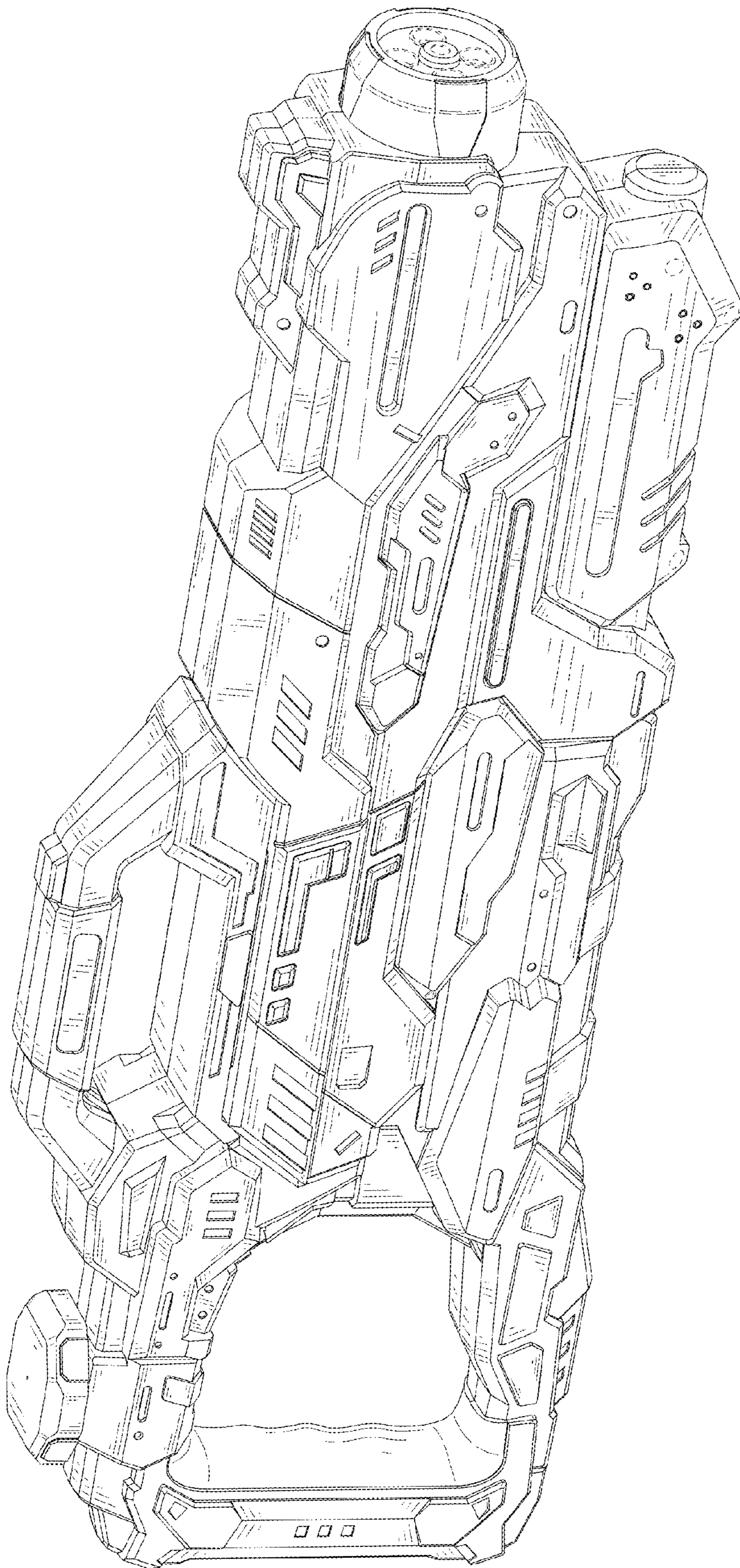

FIG. 1

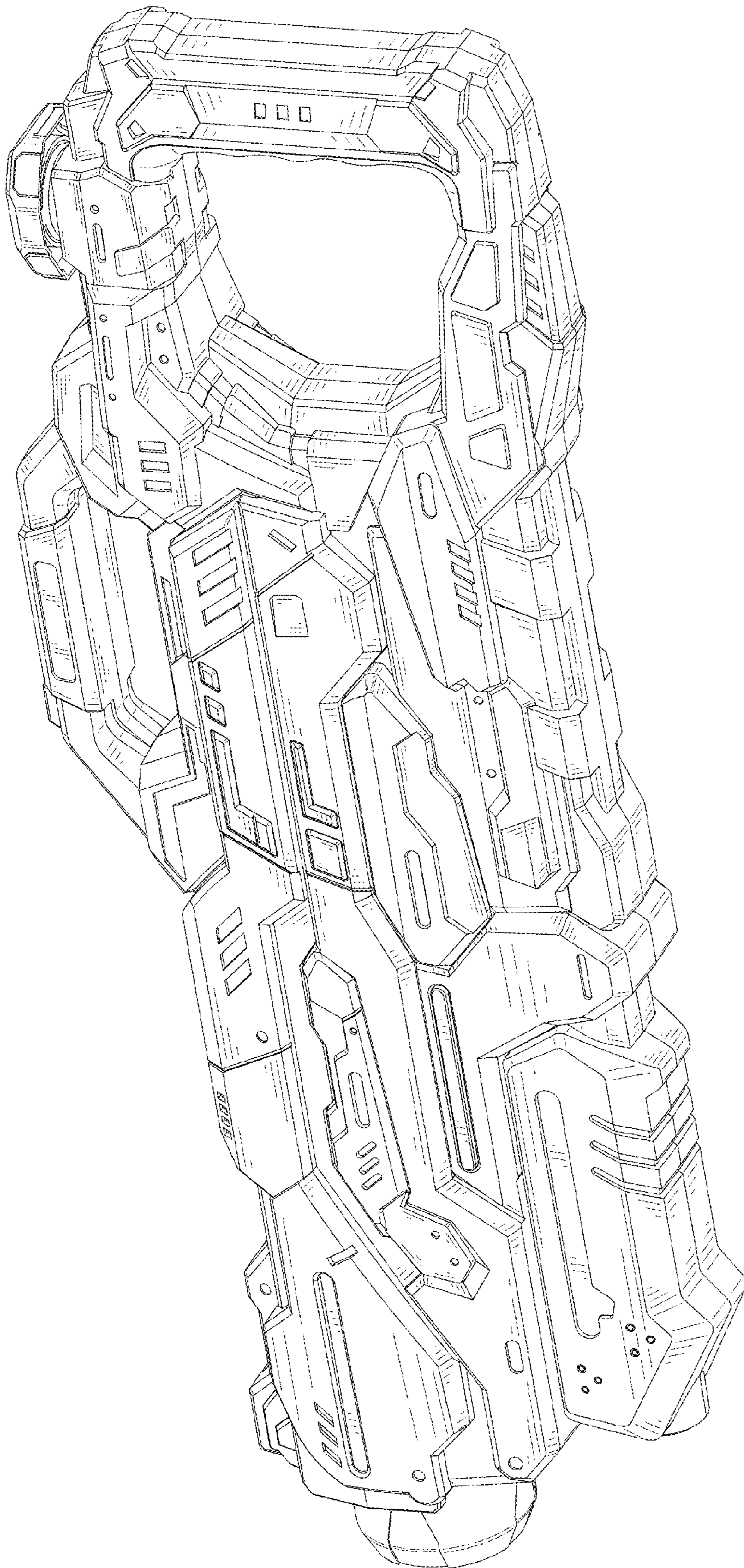

FIG. 2

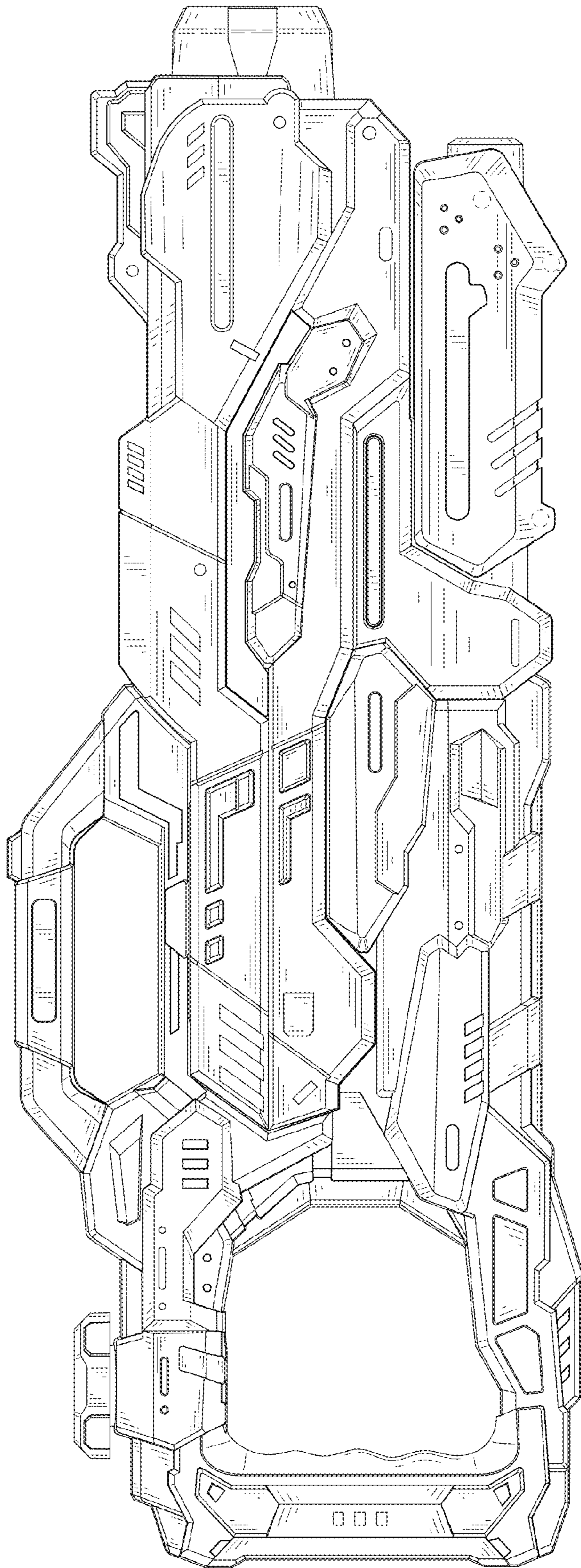

FIG. 3

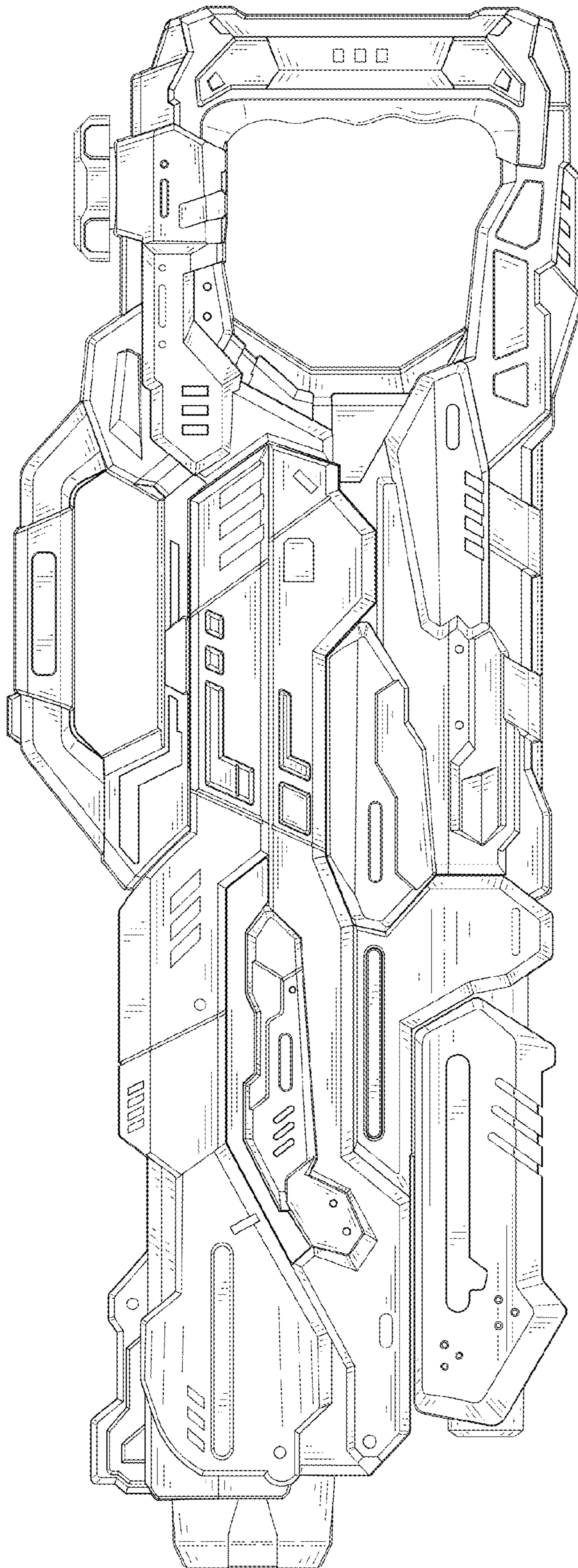

FIG. 4

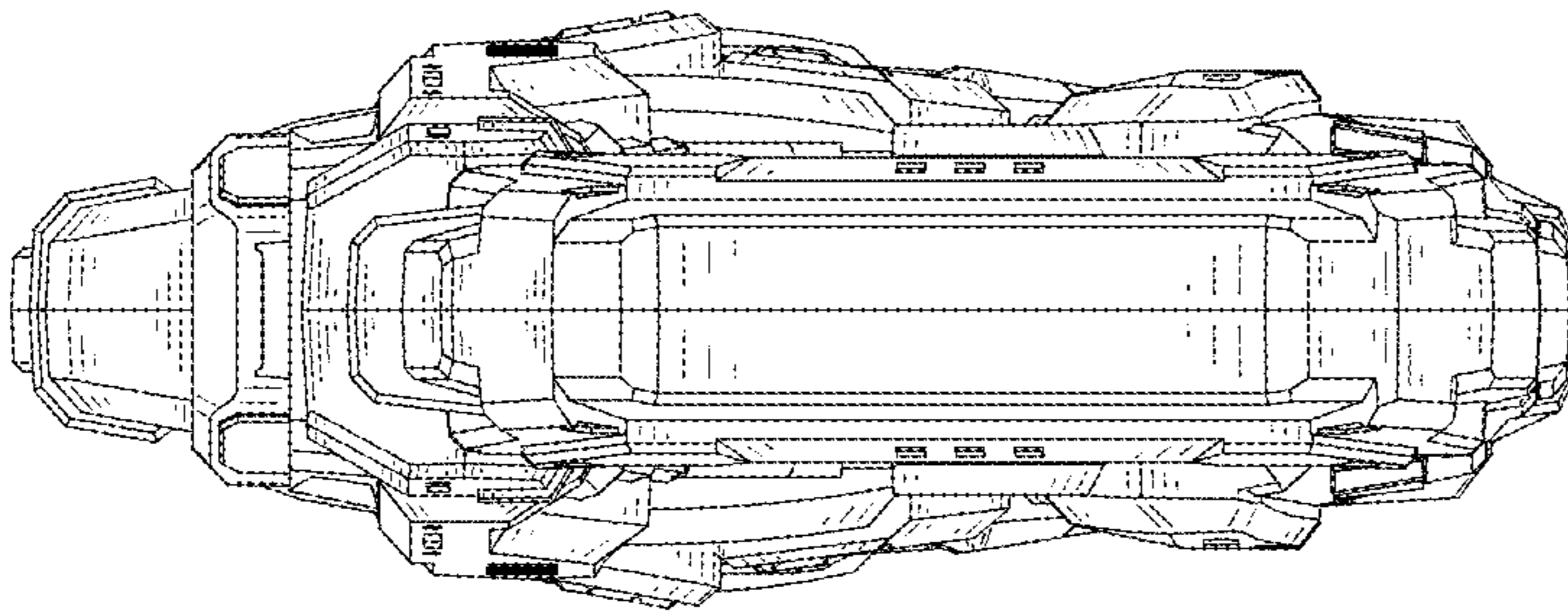

FIG. 5

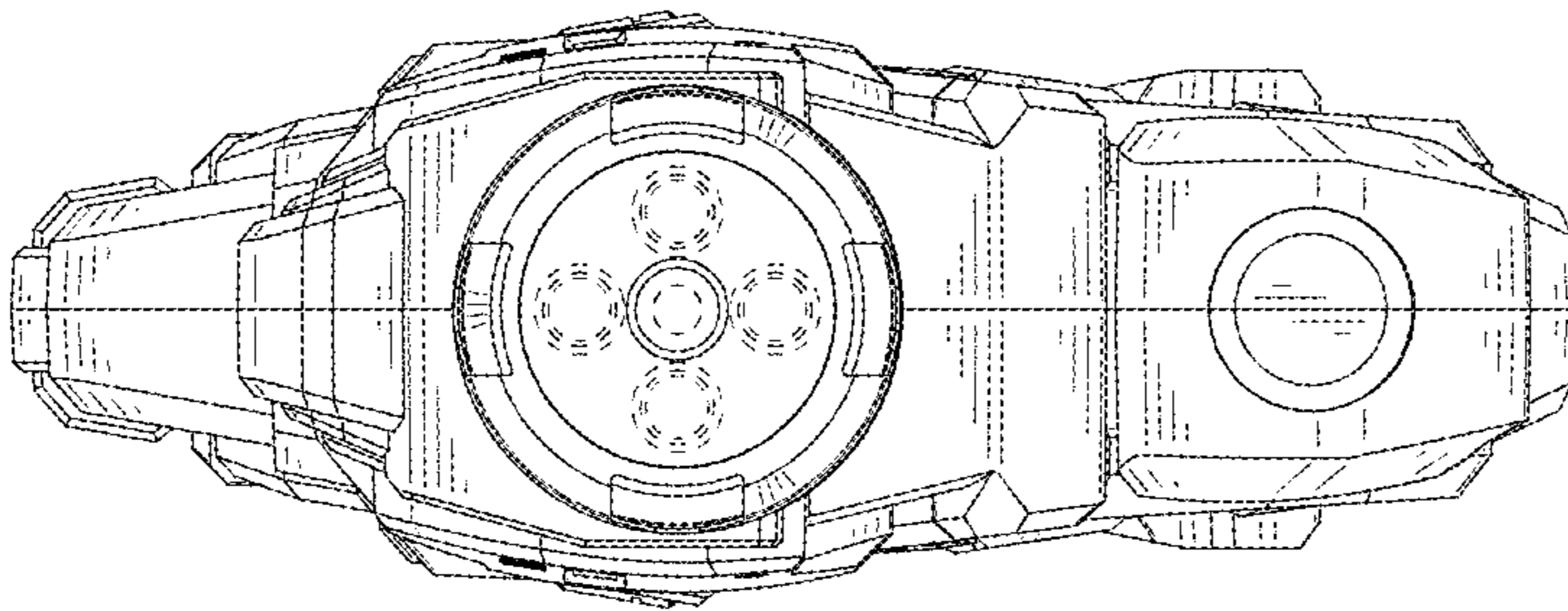

FIG. 6

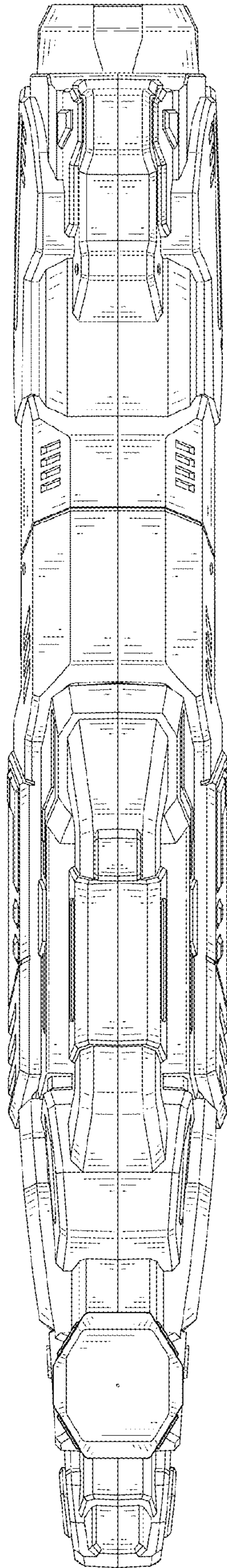

FIG. 7

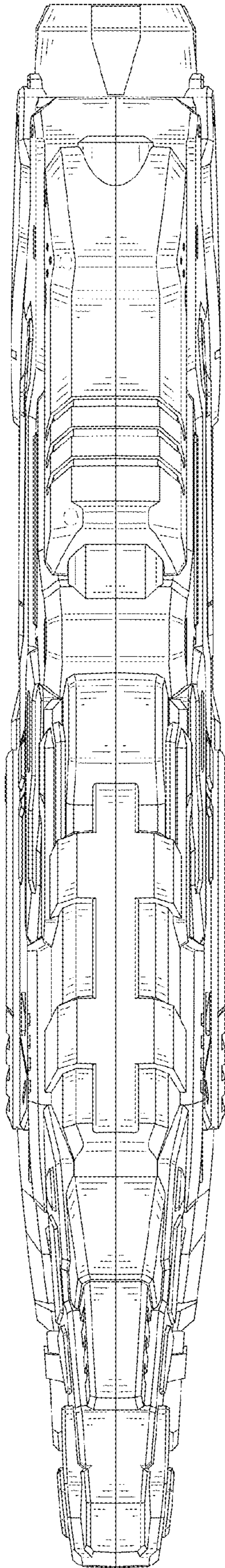

FIG. 8