



US00D951909S

(12) **United States Design Patent**
He

(10) **Patent No.:** **US D951,909 S**

(45) **Date of Patent:** **** May 17, 2022**

(54) **HEADSET**

(71) Applicant: **Liu He**, Guangzhou (CN)

(72) Inventor: **Liu He**, Guangzhou (CN)

(**) Term: **15 Years**

(21) Appl. No.: **29/762,319**

(22) Filed: **Dec. 16, 2020**

(30) **Foreign Application Priority Data**

Jul. 6, 2020 (CN) 202030358813.4

(51) **LOC (13) Cl.** **14-01**

(52) **U.S. Cl.**
USPC **D14/206**; D14/226

(58) **Field of Classification Search**
USPC D14/206, 226, 205, 372; D29/112;
2/209; 381/380, 381, 374; 455/90.3,
455/575.1, 569.1
CPC H04R 25/00; H04R 25/02; H04R 1/1066;
H04R 1/1016; H04R 5/033; H04R
5/0335; H04R 19/04; H04R 11/04; H04R
1/1091; G09G 5/00

See application file for complete search history.

(56) **References Cited**

U.S. PATENT DOCUMENTS

- 7,388,960 B2 * 6/2008 Kuo H04R 1/1041
379/430
- D609,694 S * 2/2010 Komiyama D14/205
- D617,781 S * 6/2010 Kallas D14/226
- D620,474 S * 7/2010 Komiyama D14/205
- D620,482 S * 7/2010 Chen D14/225
- D635,959 S * 4/2011 Hutchieson D14/205
- D637,176 S * 5/2011 Brunner D14/205
- D641,003 S * 7/2011 Alden D14/205
- D642,554 S * 8/2011 Schaal D14/205
- D652,405 S * 1/2012 Lee D14/205

- D674,767 S * 1/2013 Brunner D14/205
- 8,363,877 B2 * 1/2013 Morisawa H04R 5/0335
381/383
- D684,559 S * 6/2013 Groset D14/205
- D686,593 S * 7/2013 Larsen D14/205
- D691,113 S * 10/2013 Gougherty D14/206
- D691,984 S * 10/2013 Wang D14/205
- D696,226 S * 12/2013 Brunner H04R 5/033
D14/205
- D699,702 S * 2/2014 Chen D14/205
- 8,767,996 B1 * 7/2014 Lin G06F 3/165
381/380
- D716,762 S * 11/2014 Greve D14/206
- D728,512 S * 5/2015 Nakagawa D14/205
- D736,174 S * 8/2015 Levine D14/205

(Continued)

FOREIGN PATENT DOCUMENTS

EM 008464721-0001 * 3/2021

Primary Examiner — Paula Allen Greene

(74) *Attorney, Agent, or Firm* — Law Offices of Steven W. Weinrieb

(57) **CLAIM**

The ornamental design for a headset, as shown and described.

DESCRIPTION

FIG. 1 is a front, right side, top perspective view of a headset showing my new design;
 FIG. 2 is a rear, left side, bottom perspective view thereof;
 FIG. 3 is a front elevational view thereof;
 FIG. 4 is a rear elevational view thereof;
 FIG. 5 is a left side elevational view thereof;
 FIG. 6 is a right side elevational view thereof;
 FIG. 7 is a top plan view thereof; and,
 FIG. 8 is a bottom plan view thereof.
 The broken lines depict portions of the headset that form no part of the claimed design.

1 Claim, 8 Drawing Sheets



(56)

References Cited

U.S. PATENT DOCUMENTS

D741,842 S * 10/2015 Levine D14/226
 D750,041 S * 2/2016 Birger D14/205
 D766,208 S * 9/2016 Paterson D14/205
 D766,870 S * 9/2016 Catalano D14/205
 D768,110 S * 10/2016 Suzuki D14/205
 D782,999 S * 4/2017 Spio D14/206
 D786,824 S * 5/2017 Hembrey D14/205
 D795,218 S * 8/2017 Ohmachi D14/205
 D795,835 S * 8/2017 Nagamine D14/205
 D800,092 S * 10/2017 Paterson D14/206
 D806,675 S * 1/2018 Fuglsang D14/206
 D810,055 S * 2/2018 Levine D14/226
 D835,080 S * 12/2018 Chen D14/226
 10,178,563 B2 * 1/2019 Tang H04W 24/08
 D840,370 S * 2/2019 Kelly D14/205
 D841,620 S * 2/2019 Liu D14/206
 D855,036 S * 7/2019 Yan D14/206
 D864,155 S * 10/2019 Liu D14/206
 D869,437 S * 12/2019 Hu D14/205
 D870,069 S * 12/2019 Hu D14/206
 D870,696 S * 12/2019 Deng D14/206
 D872,050 S * 1/2020 Liu D14/206
 D875,073 S * 2/2020 Pedersen D14/206
 D877,116 S * 3/2020 Liu D14/206
 D877,715 S * 3/2020 Hu D14/205

D879,742 S * 3/2020 Hu D14/205
 D881,157 S * 4/2020 Chen D14/205
 D881,843 S * 4/2020 Hu D14/206
 D883,949 S * 5/2020 Hu D14/205
 D885,363 S * 5/2020 Li D14/205
 D888,008 S * 6/2020 Yook D14/205
 D890,129 S * 7/2020 Liu D14/206
 D894,867 S * 9/2020 Choe D14/205
 D899,401 S * 10/2020 Smiechowski D14/205
 D900,069 S * 10/2020 Murata D14/225
 D904,338 S * 12/2020 Treski D14/205
 D904,339 S * 12/2020 Wang D14/205
 D907,004 S * 1/2021 Zhou D14/206
 D909,337 S * 2/2021 Liu D14/206
 D915,348 S * 4/2021 He D14/206
 D916,681 S * 4/2021 He D14/205
 D924,842 S * 7/2021 Chan D14/206
 D927,458 S * 8/2021 Su D14/206
 D928,116 S * 8/2021 Su D14/206
 D931,831 S * 9/2021 Liu D14/206
 D935,441 S * 11/2021 Liu D14/206
 2013/0343591 A1 * 12/2013 Brunner H04R 1/1075
 381/371
 2015/0382101 A1 * 12/2015 Dai H04R 1/1091
 381/375
 2016/0198251 A1 * 7/2016 Pan H04R 1/105
 381/74

* cited by examiner

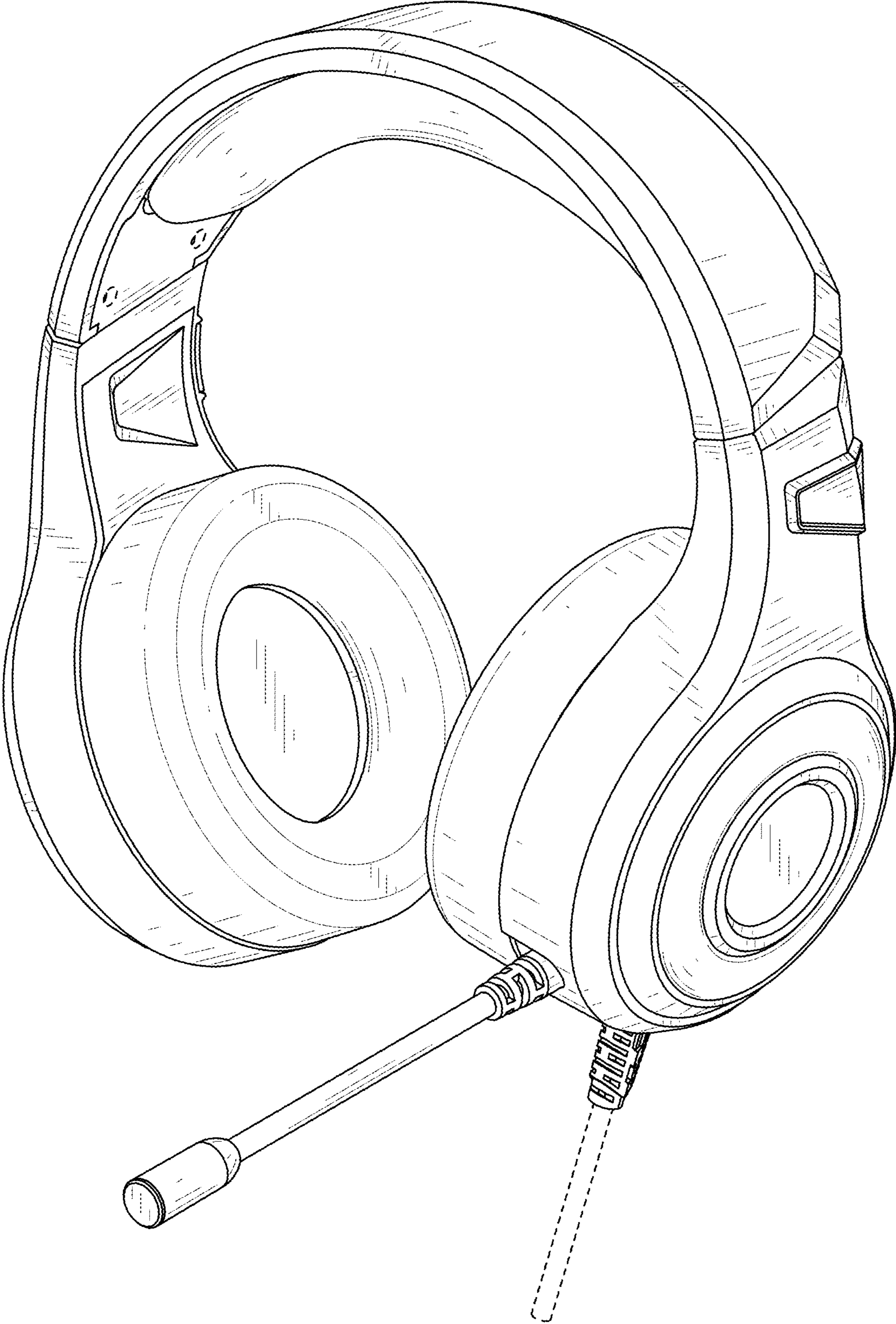

FIG. 1

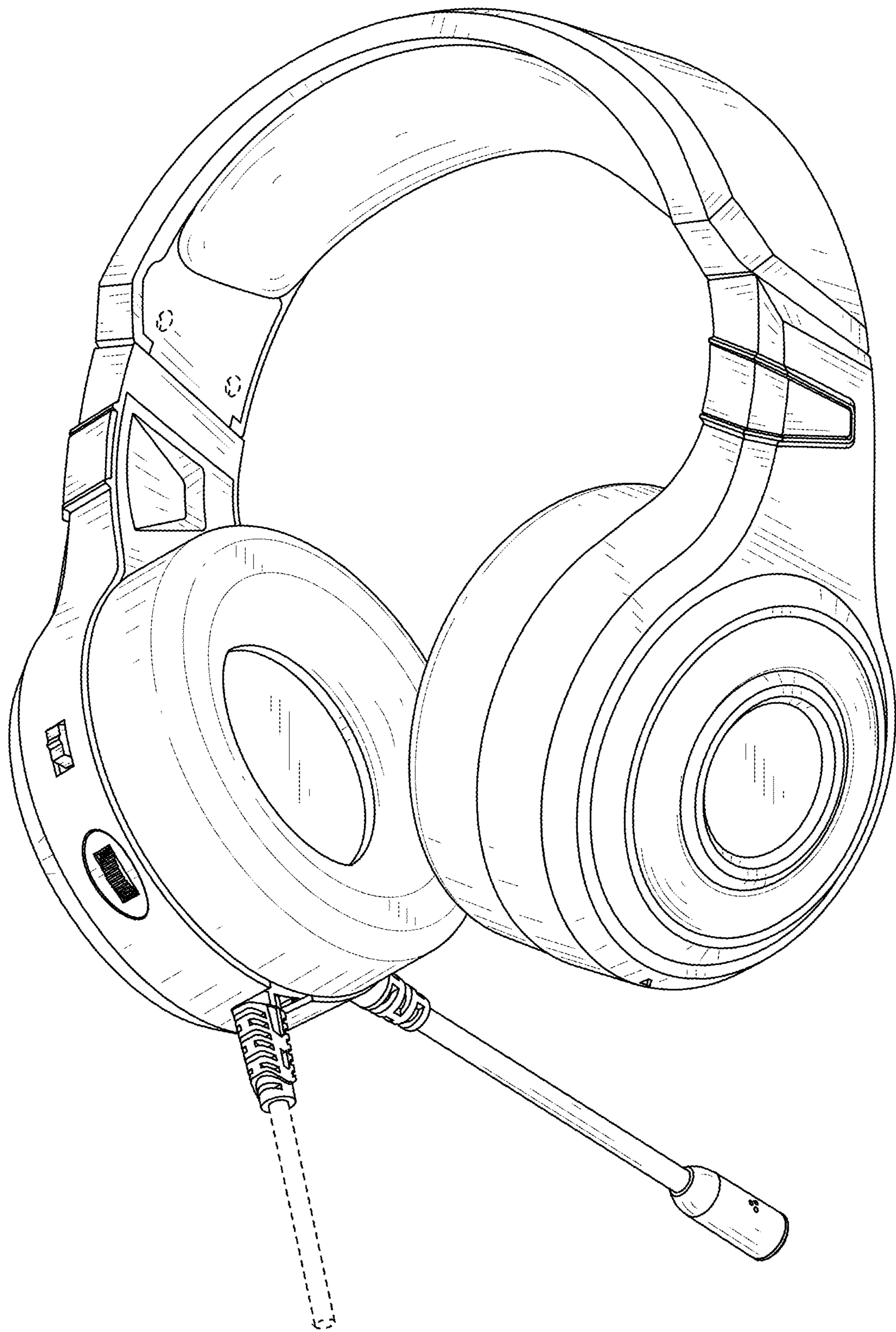

FIG. 2

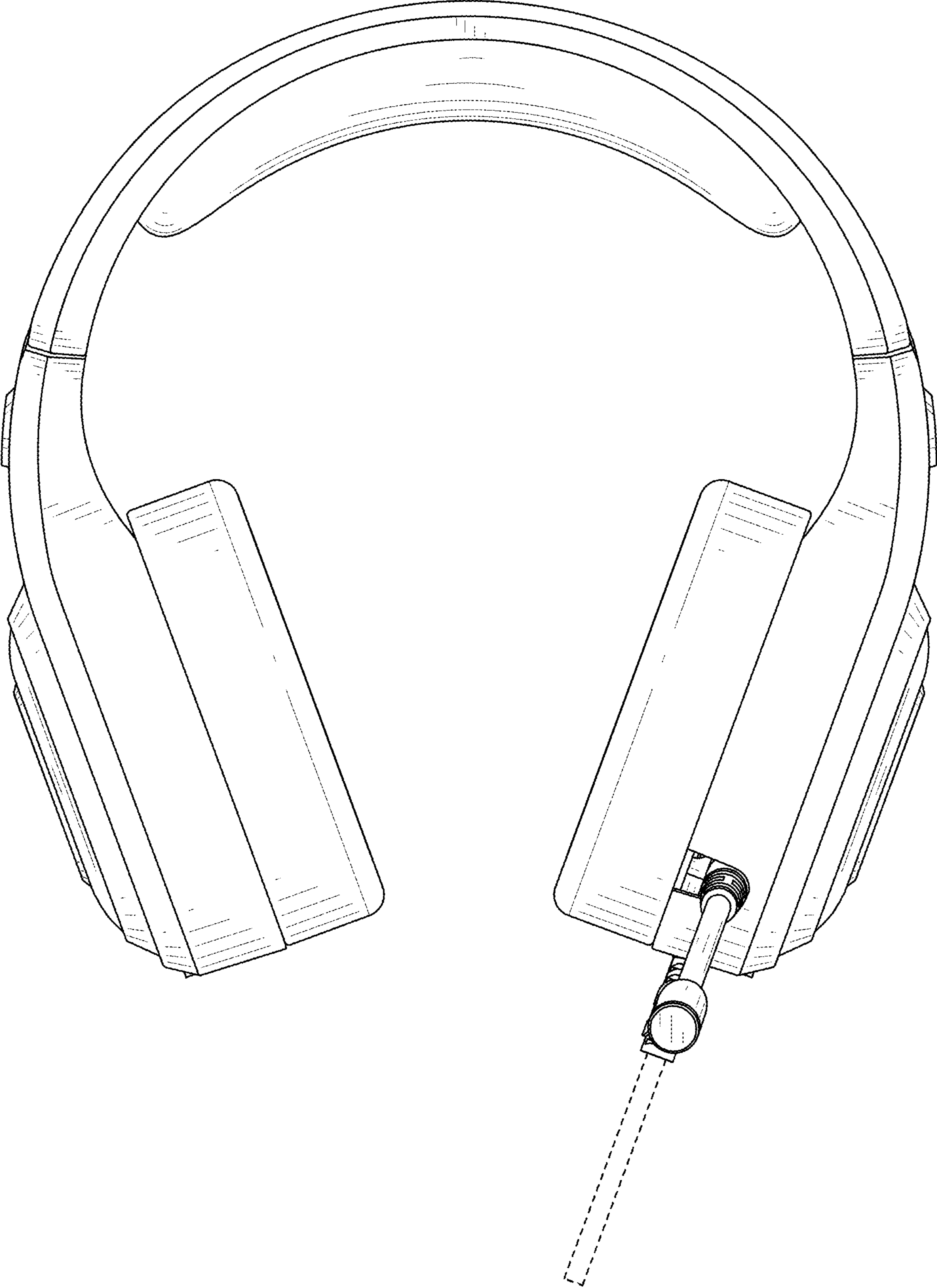

FIG. 3



FIG. 4

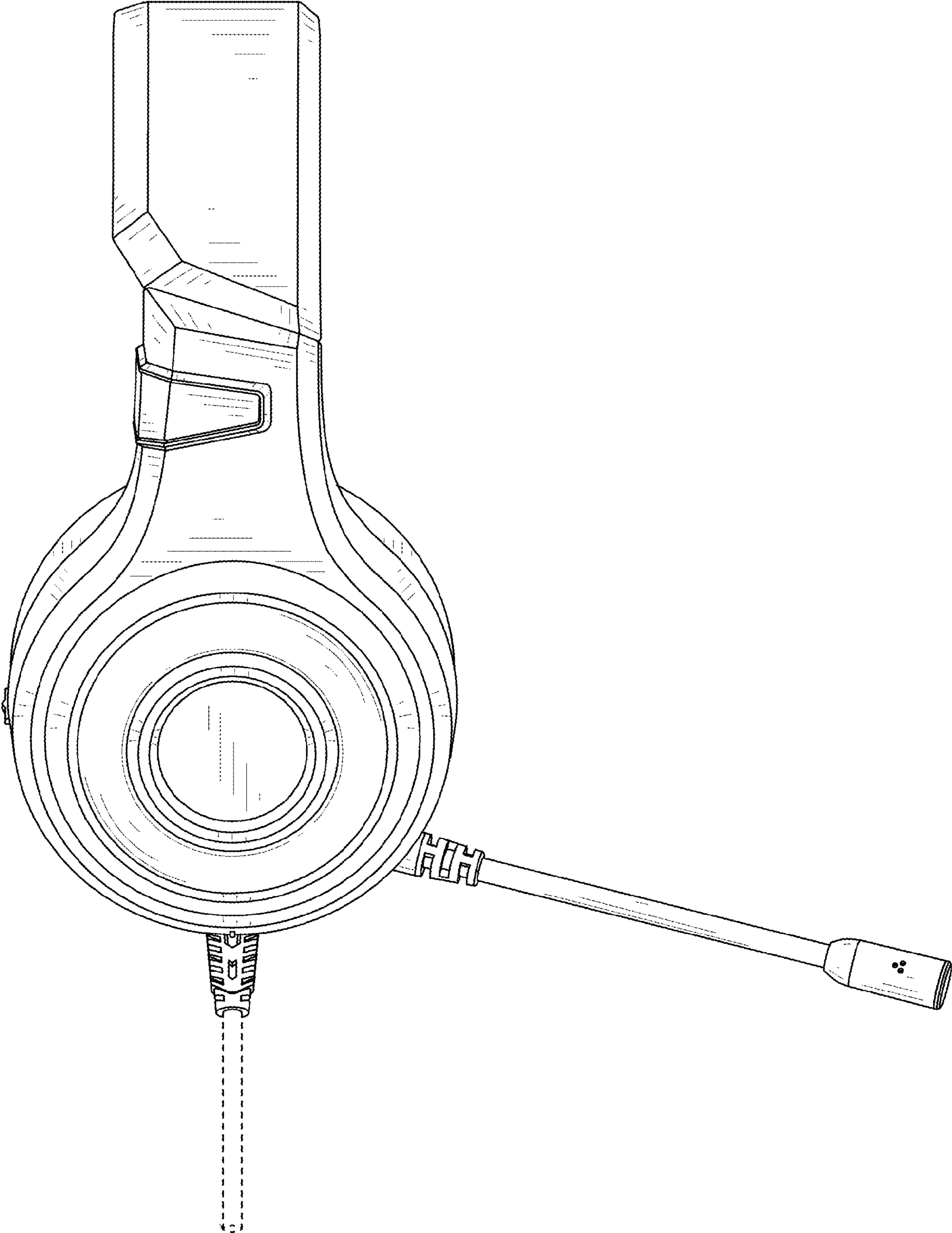

FIG. 5

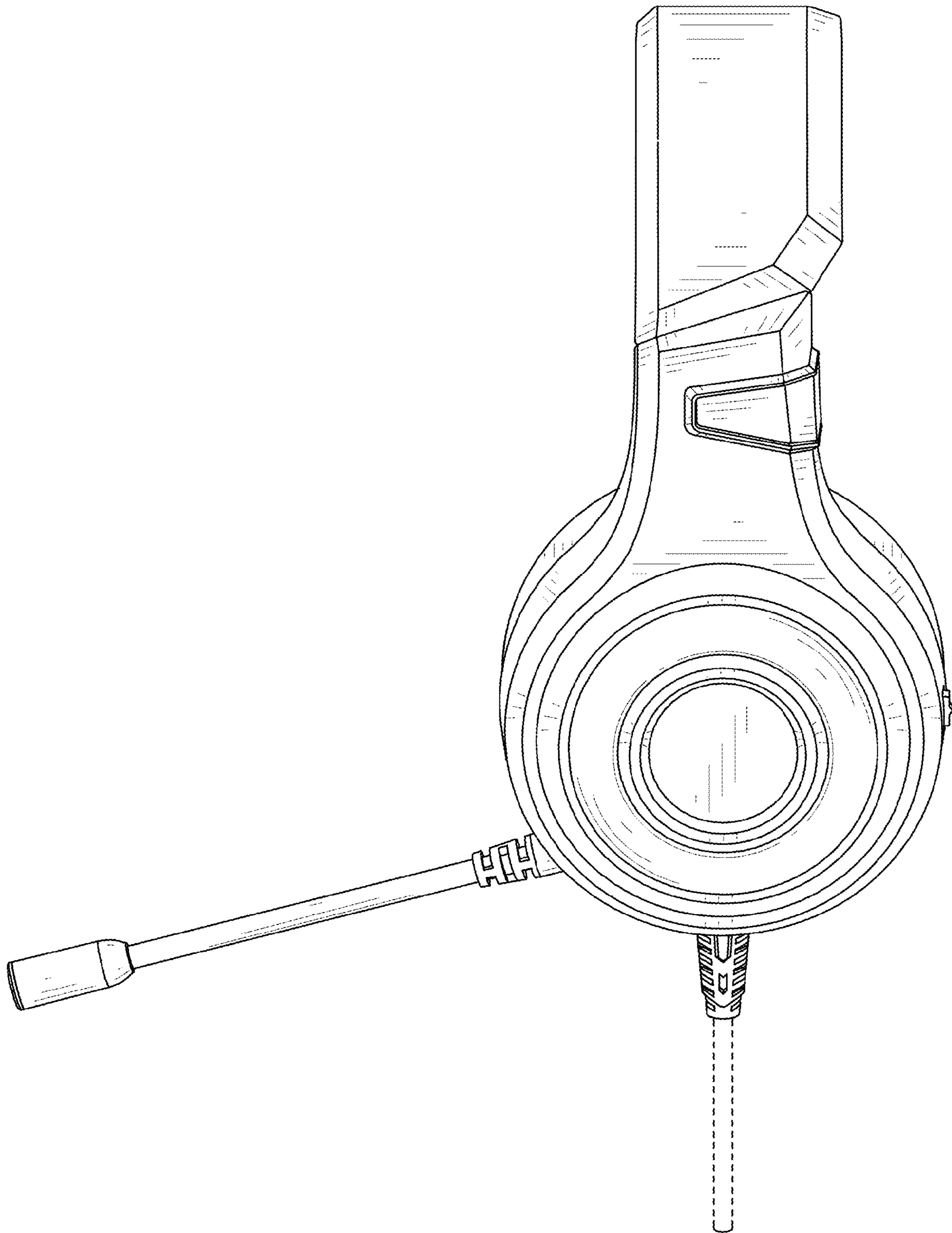

FIG. 6

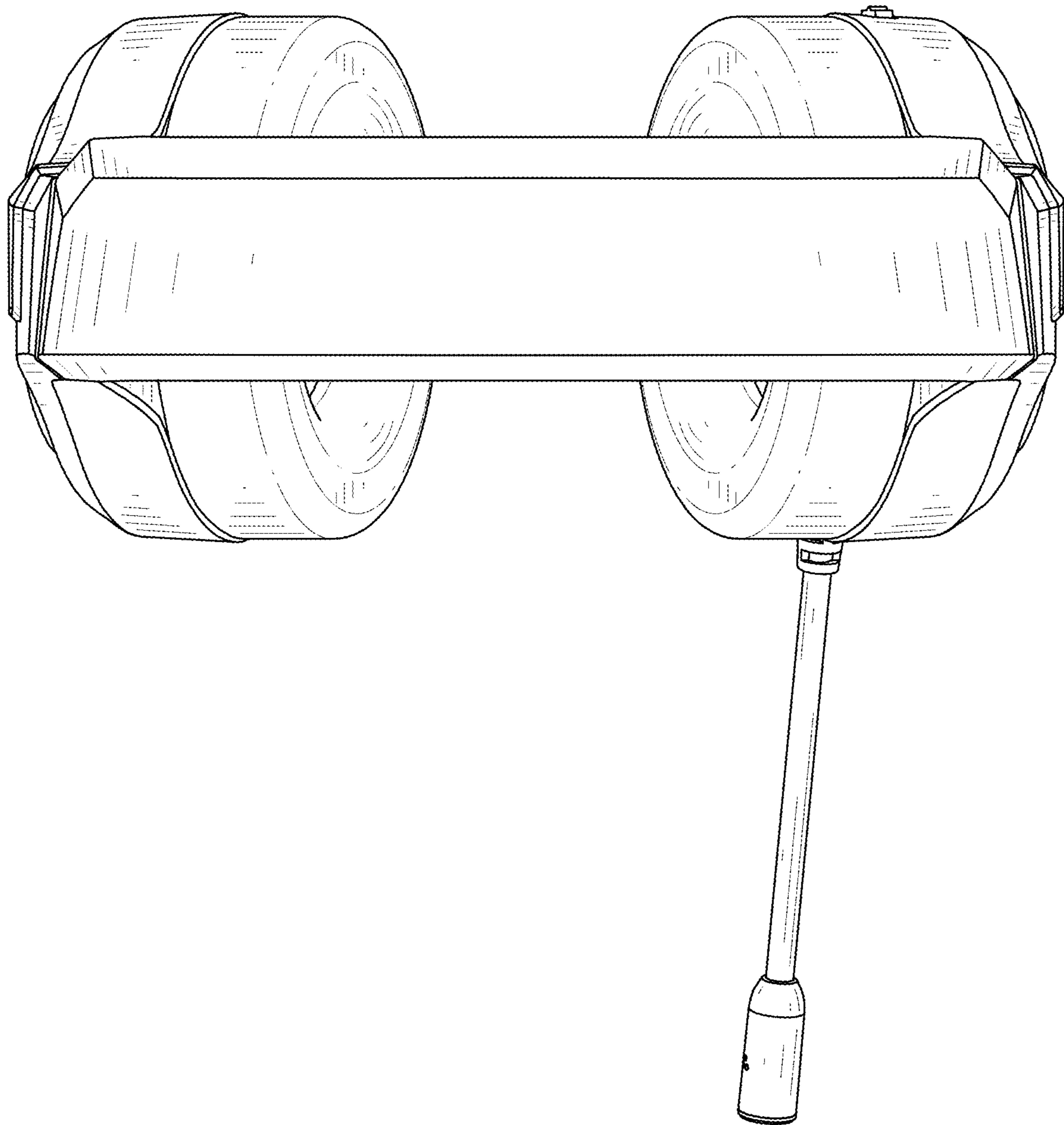

FIG. 7

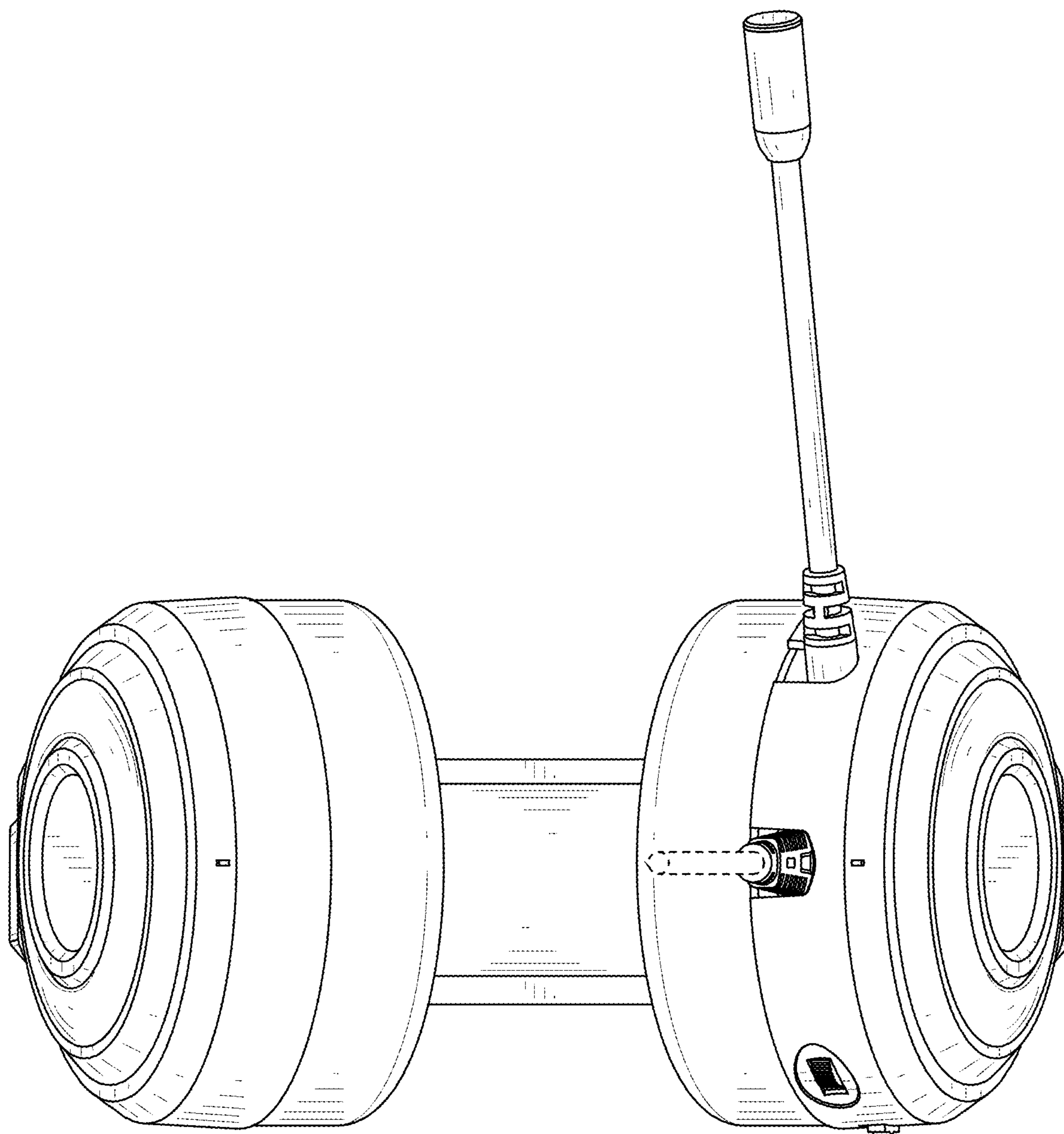

FIG. 8