



US00D951903S

(12) **United States Design Patent**  
**Kim et al.**

(10) **Patent No.:** **US D951,903 S**

(45) **Date of Patent:** **\*\* May 17, 2022**

(54) **SOUND BAR**

(71) Applicant: **Samsung Electronics Co., Ltd.**,  
Suwon-si (KR)

(72) Inventors: **Jun-Pyo Kim**, Suwon-si (KR); **Sung-II Bang**, Suwon-si (KR); **Byung Wook Kang**, Suwon-si (KR)

(73) Assignee: **Samsung Electronics Co., Ltd.**,  
Suwon-si (KR)

(\*\*) Term: **15 Years**

(21) Appl. No.: **29/723,191**

(22) Filed: **Feb. 5, 2020**

(30) **Foreign Application Priority Data**

Aug. 23, 2019 (KR) ..... 30-2019-0040376

(51) **LOC (13) Cl.** ..... **14-01**

(52) **U.S. Cl.**  
USPC ..... **D14/204**

(58) **Field of Classification Search**  
USPC ..... D14/170-172, 188, 203.1, 203.3, 204,  
D14/348

(Continued)

(56) **References Cited**

**U.S. PATENT DOCUMENTS**

D538,260 S \* 3/2007 Wada ..... D14/188  
D589,519 S \* 3/2009 Smith ..... D14/461

(Continued)

**FOREIGN PATENT DOCUMENTS**

EM 001397657-0002 3/2016  
EM 001397657-0003 3/2016  
KR 30-2014-0063824 8/2015

*Primary Examiner* — Janice Patyk

(74) *Attorney, Agent, or Firm* — NSIP Law

(57) **CLAIM**

We claim the ornamental design for a sound bar, as shown and described.

**DESCRIPTION**

FIG. 1 is a front perspective view of a sound bar showing our new design;

FIG. 2 is a front view thereof;

FIG. 3 is a rear view thereof;

FIG. 4 is a left-side view thereof;

FIG. 5 is a right-side view thereof;

FIG. 6 is a top view thereof;

FIG. 7 is a bottom view thereof;

FIG. 8 is a bottom rear perspective view thereof;

FIG. 9 is a partially enlarged view thereof, taken from FIG. 1;

FIG. 10 is a partially enlarged view thereof, taken from FIG. 1;

FIG. 11 is a partially enlarged view thereof, taken from FIG. 3;

FIG. 12 is a partially enlarged view thereof taken from FIG. 6;

FIG. 13 is a partially enlarged view thereof taken from FIG. 7;

FIG. 14 is a partially enlarged view thereof taken from FIG. 7;

FIG. 15 is a partially enlarged view thereof taken from FIG. 8; and,

FIG. 16 is a partially enlarged view thereof taken from FIG. 8.

The evenly-dashed broken lines in the figures depict portions of the sound bar which form no part of the claimed design.

The dot-dash broken lines of FIGS. 1, 3 and 6-16 are included to show partially enlarged views only and form no part of the claimed design.

The broken lines along the bottom edges of the sound bar of FIGS. 7, 8 and 13 through 16 are included to show unclaimed seam lines on the article.

**1 Claim, 16 Drawing Sheets**

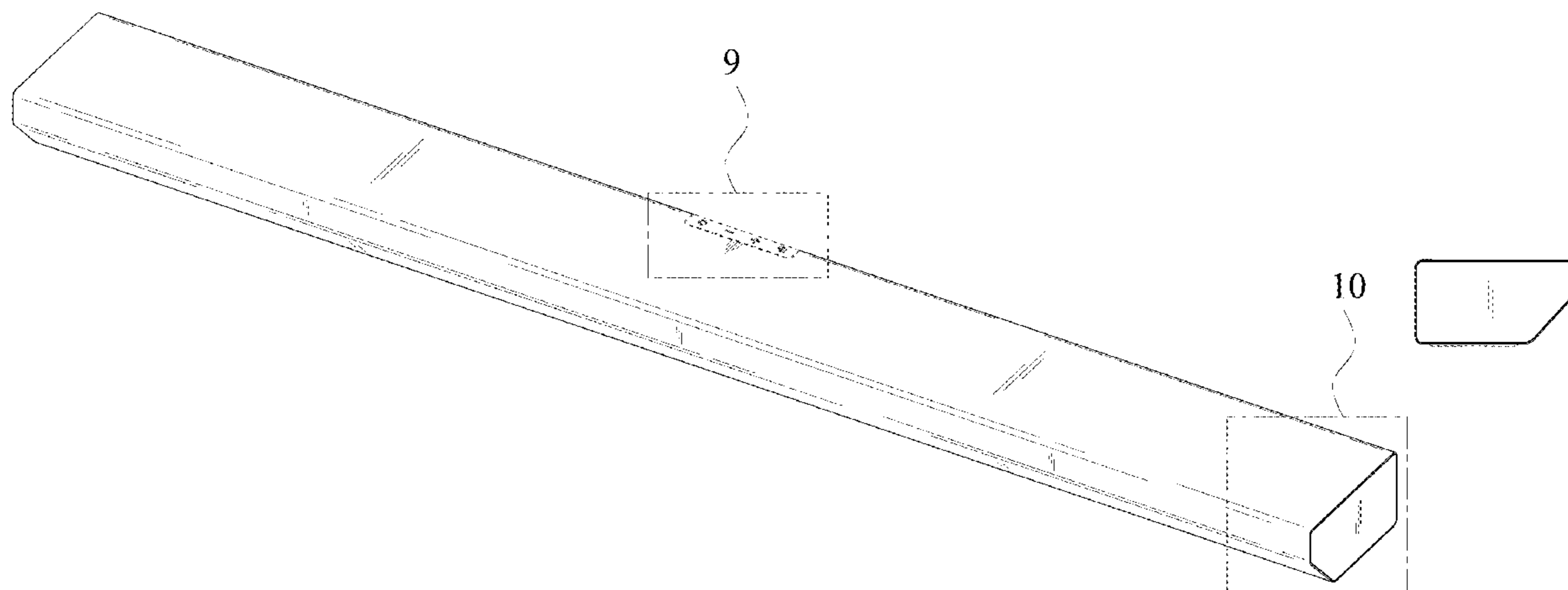

(58) **Field of Classification Search**

CPC . H04R 1/02; H04R 1/023; H04R 5/00; H04R  
7/00; H04R 7/02; H04R 9/06; H04R  
2400/00

See application file for complete search history.

(56) **References Cited**

U.S. PATENT DOCUMENTS

D688,231	S	8/2013	Nishii	
D726,153	S *	4/2015	Chang	D14/215
D738,853	S *	9/2015	Savage	D14/214
D754,629	S *	4/2016	Kim	D14/204
D760,685	S	7/2016	Sugiura	
D800,693	S *	10/2017	Sugiura	D14/214
D842,273	S *	3/2019	Kiong	D14/214
D861,642	S *	10/2019	Werle	D14/214
D894,155	S *	8/2020	Gu	D14/214

\* cited by examiner

FIG. 1

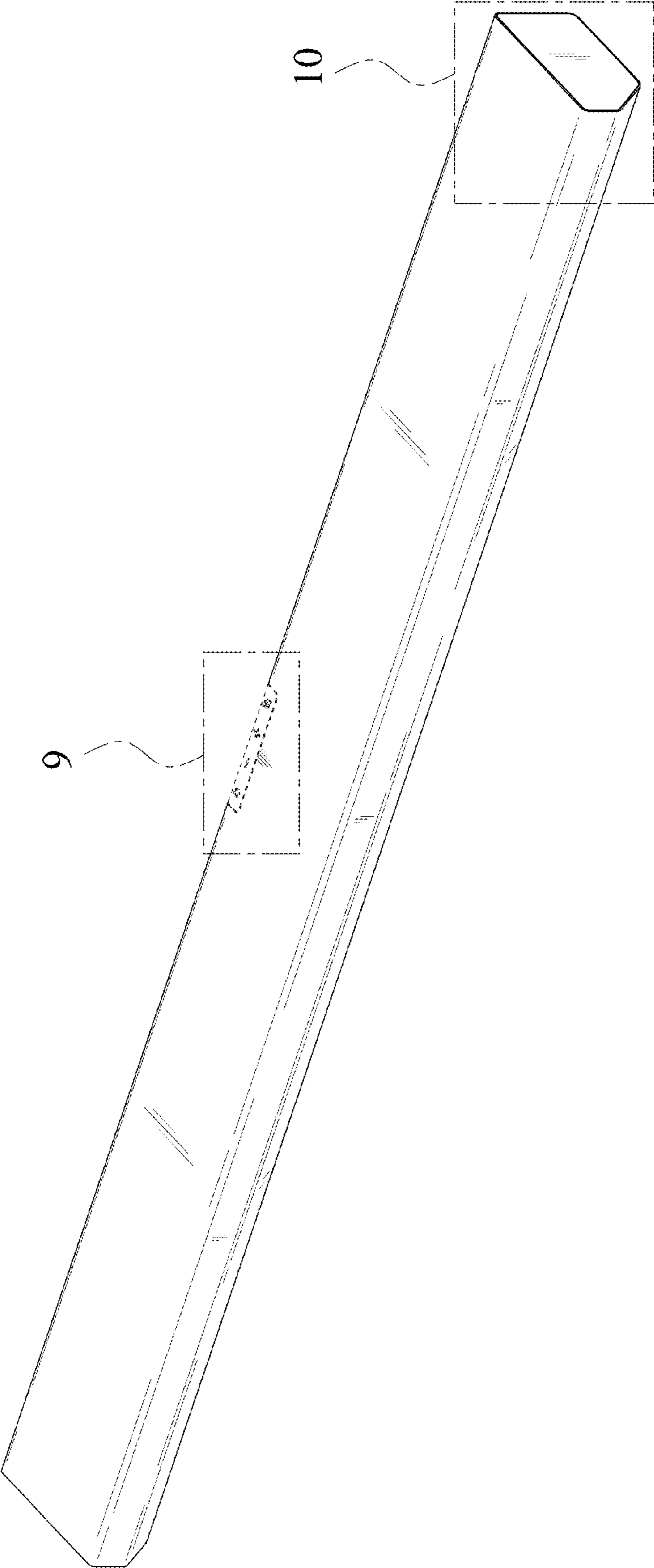

FIG. 2

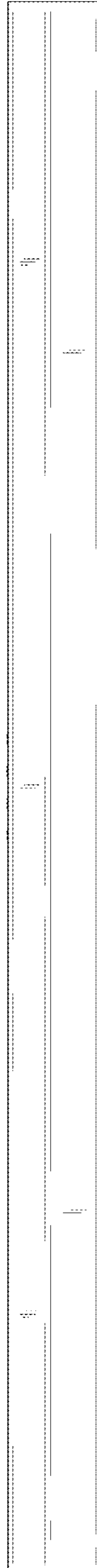

FIG. 3

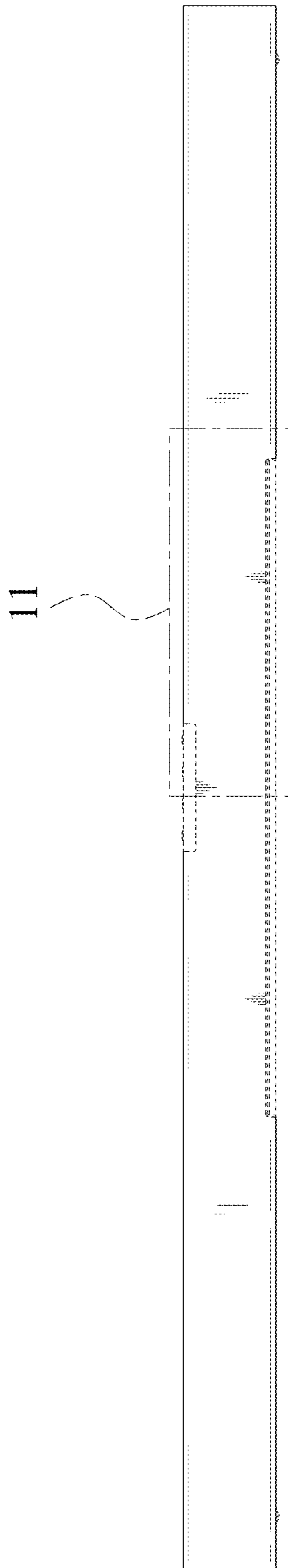

FIG. 4

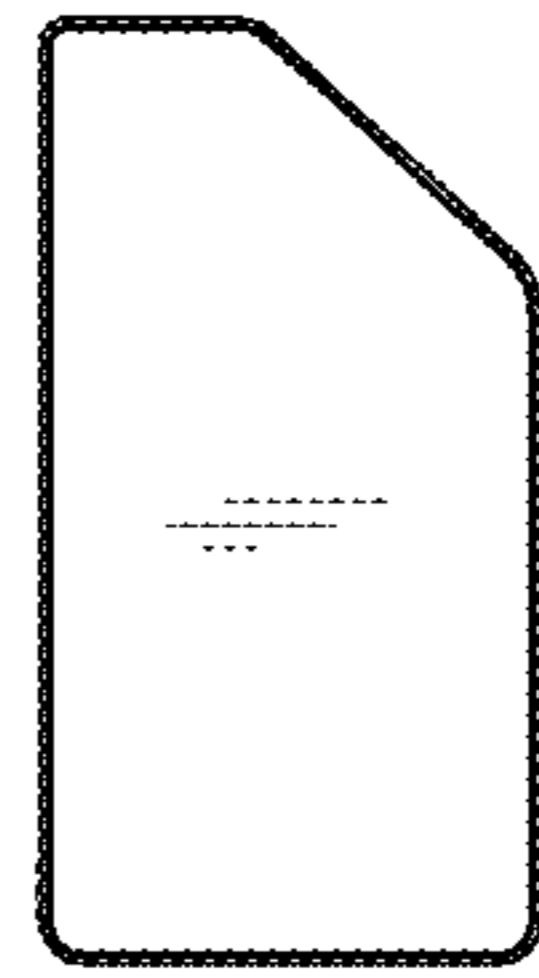

FIG. 5

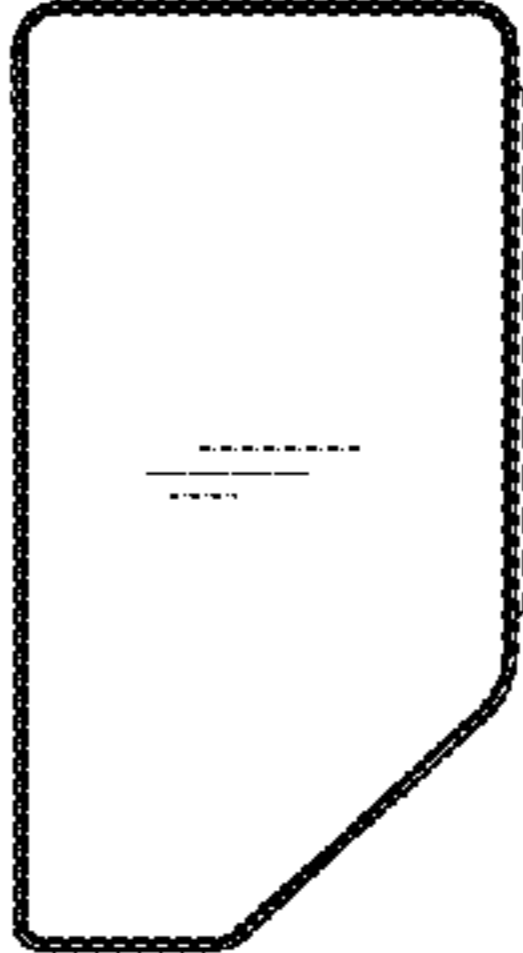

FIG. 6

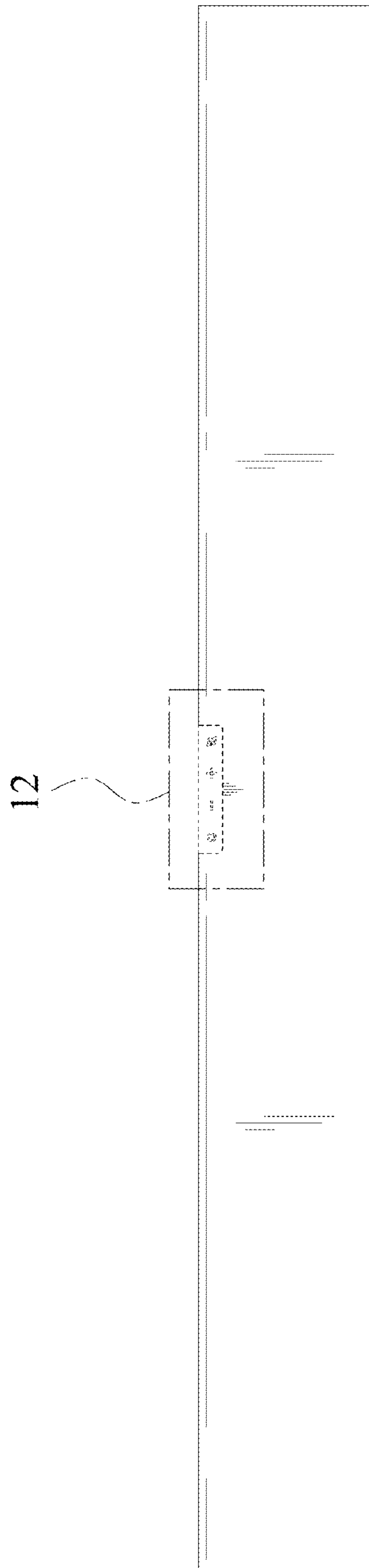



FIG. 7

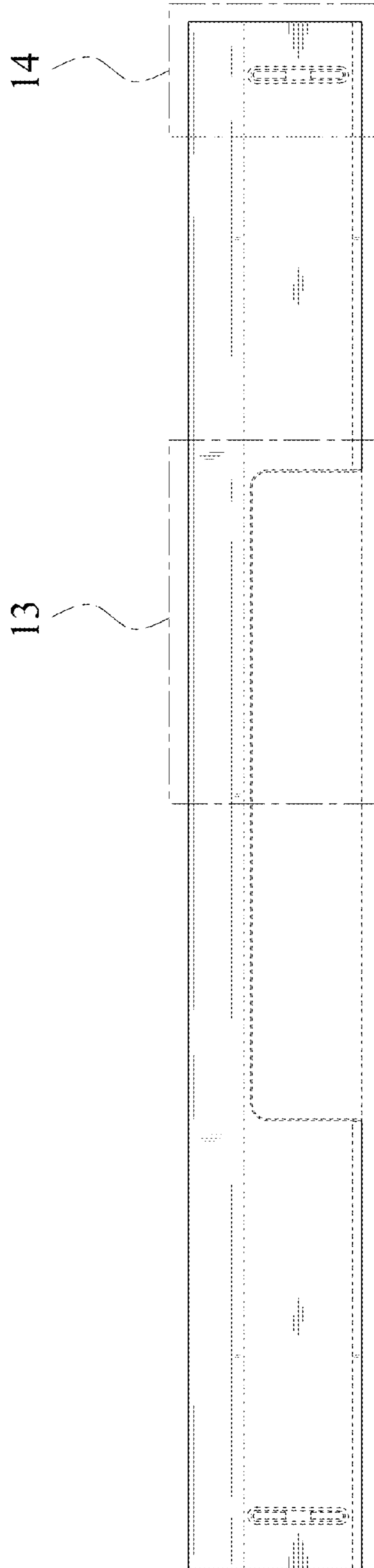

FIG. 8

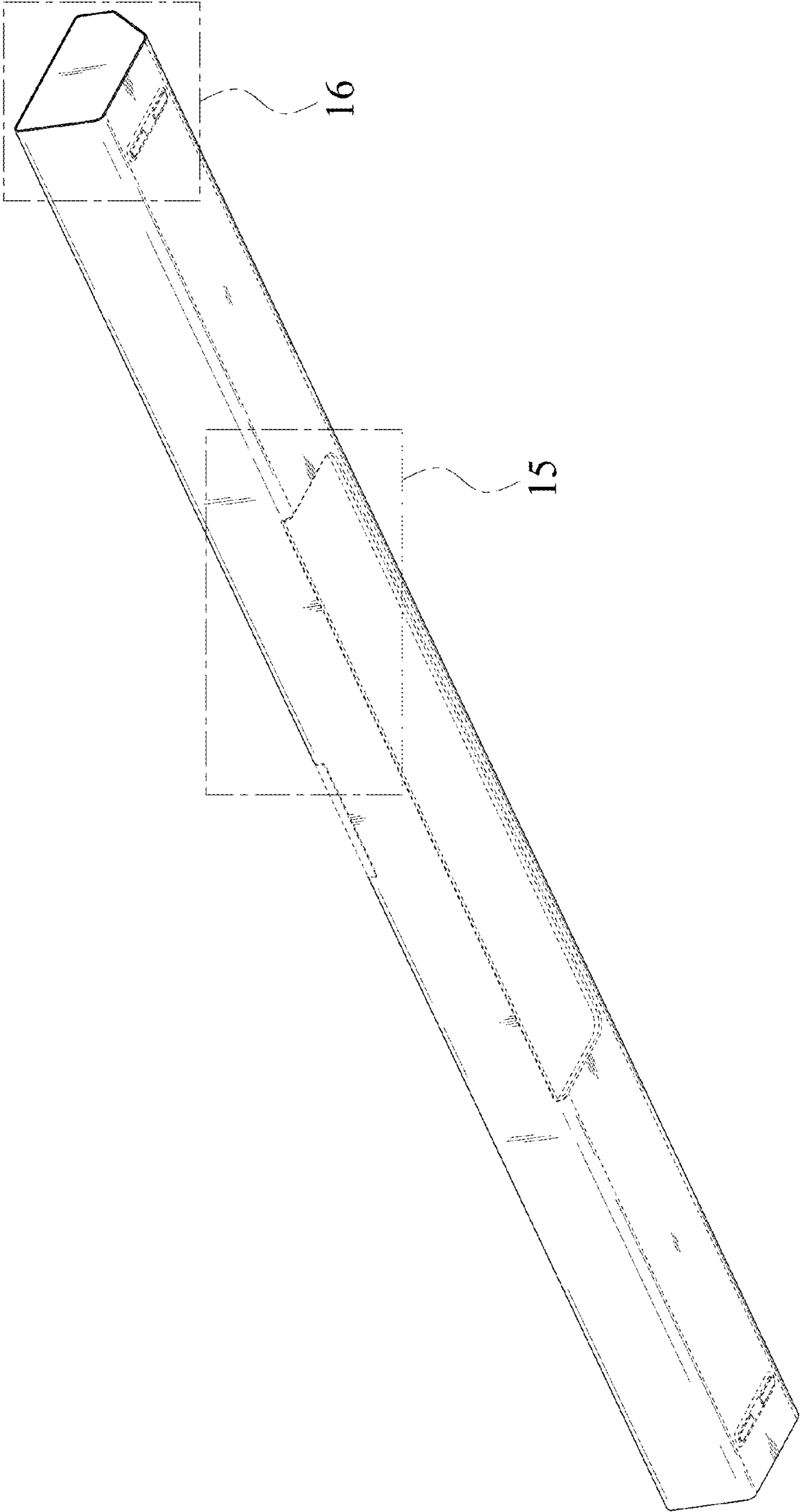

FIG. 9

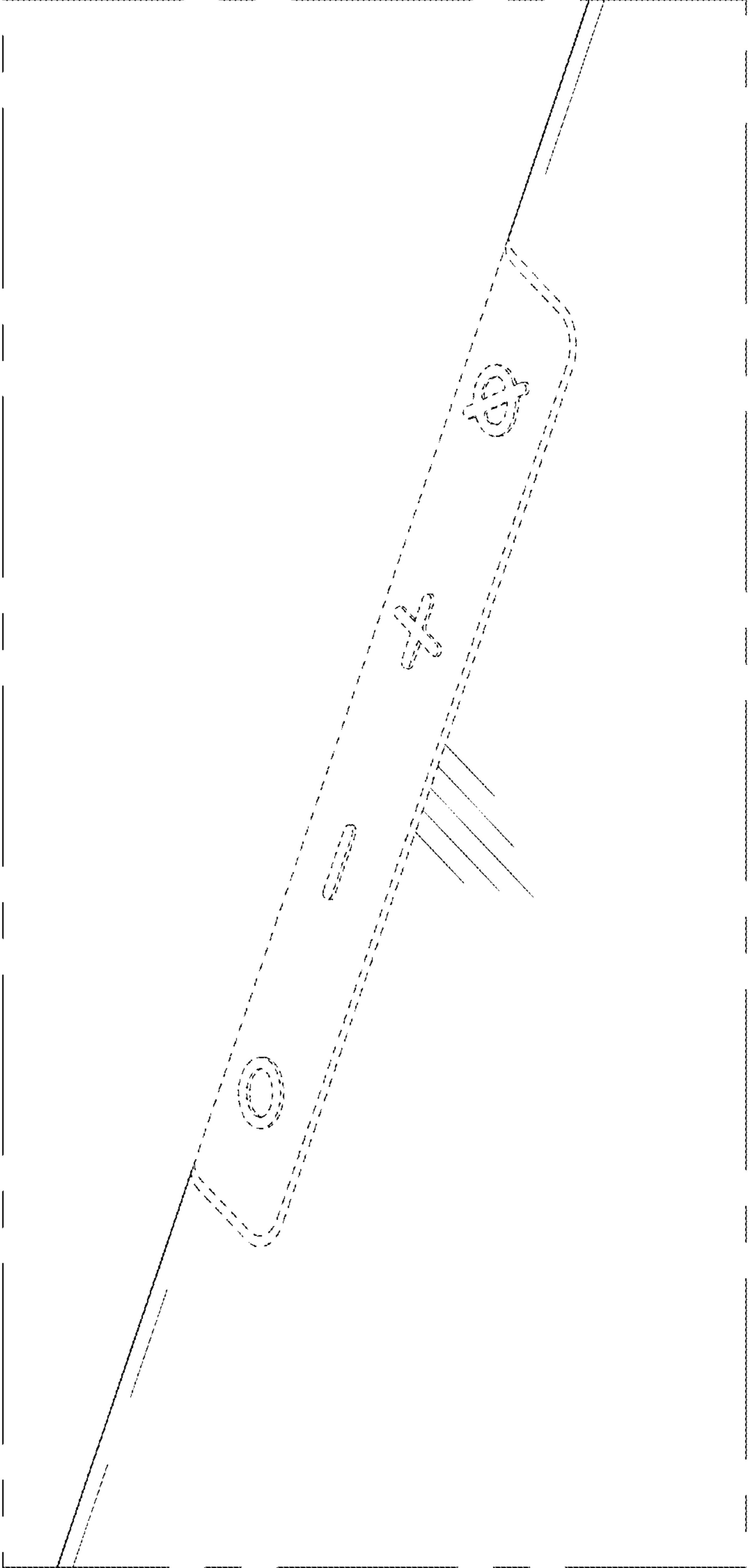

FIG. 10

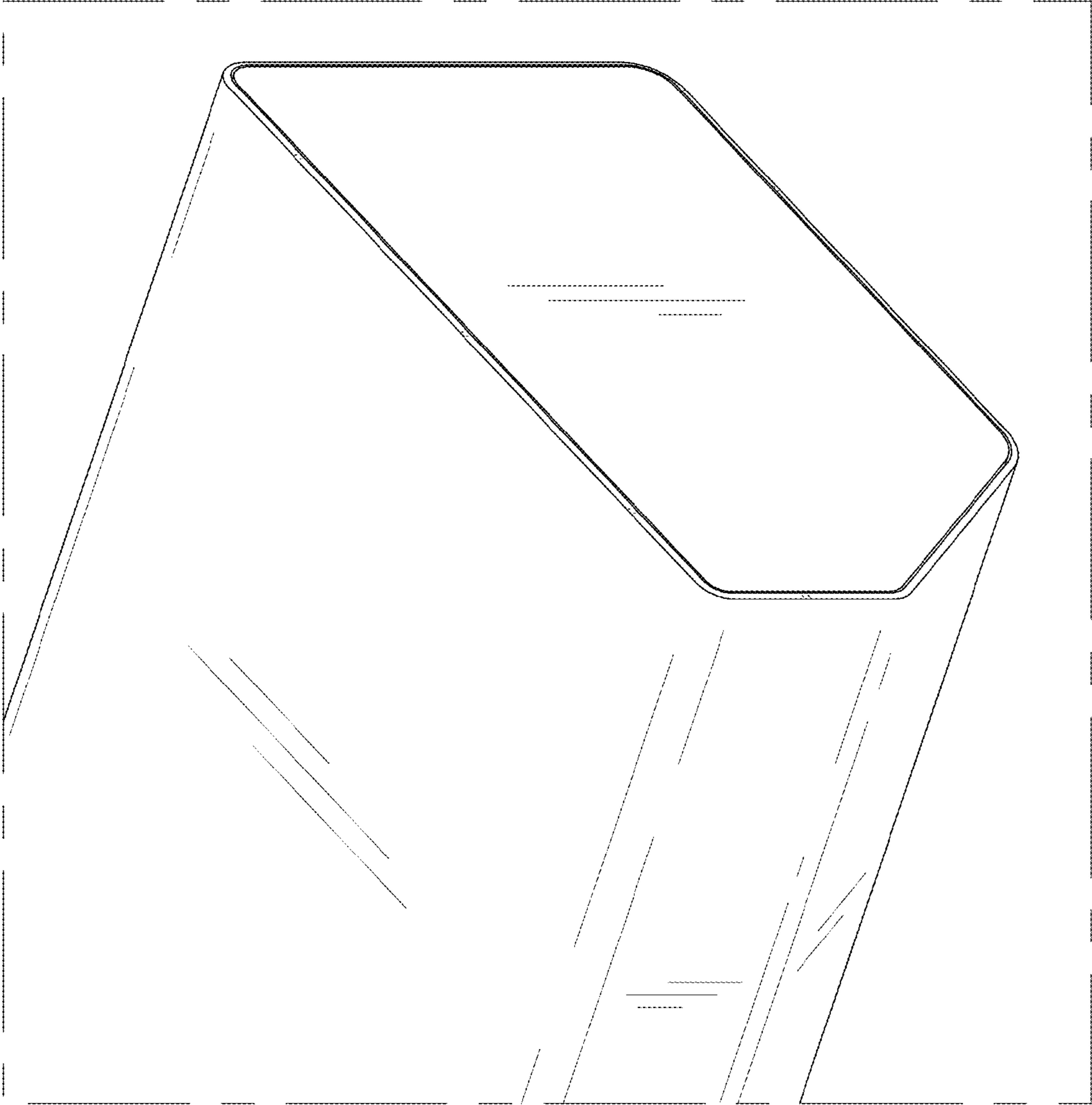

FIG. 11

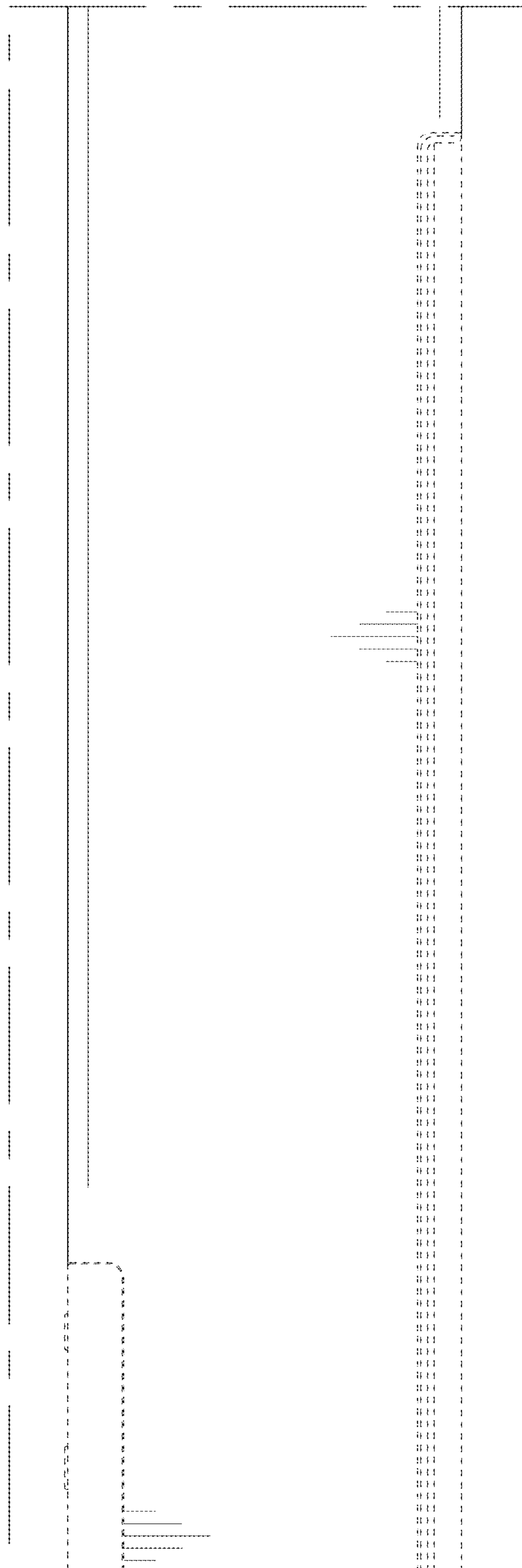

FIG. 12

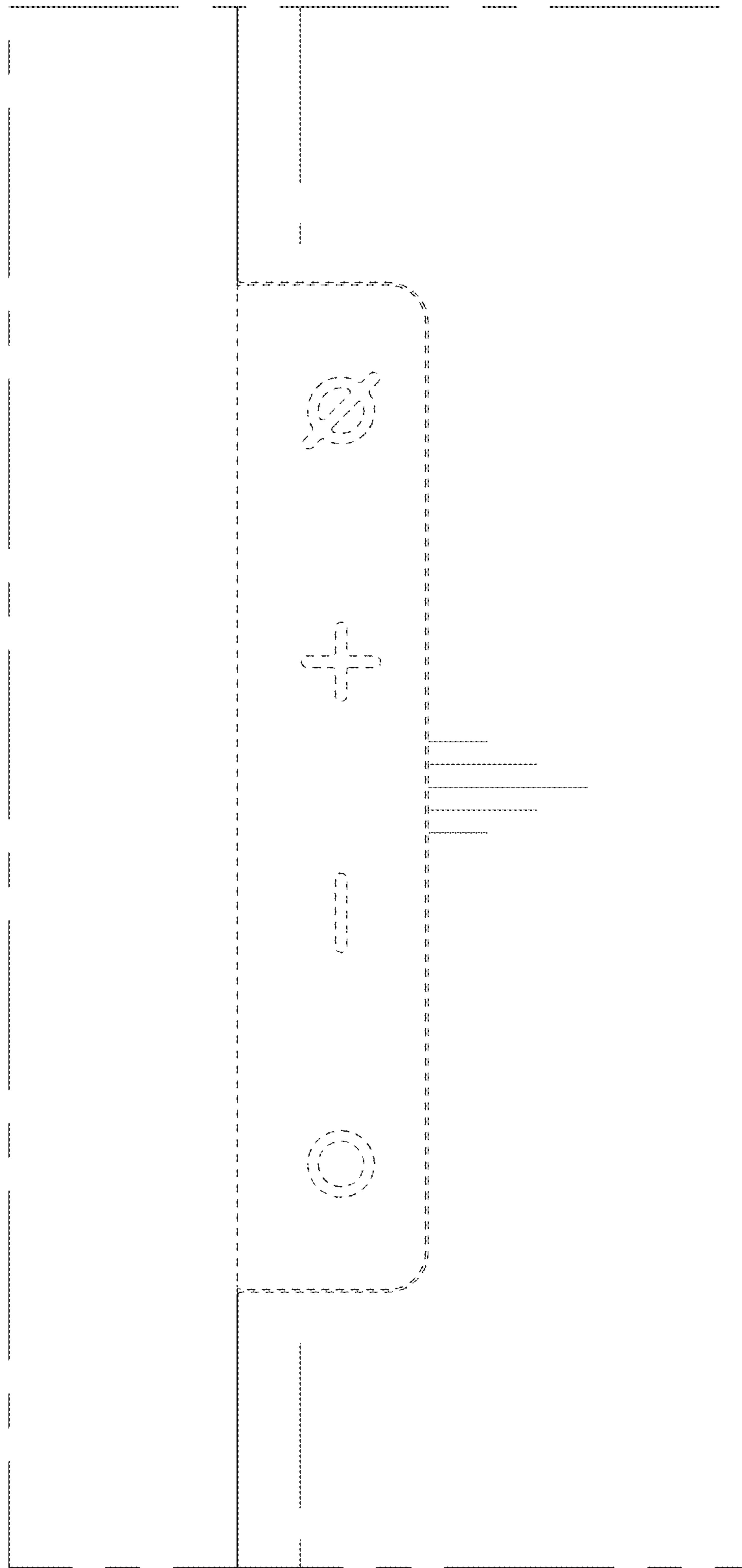

FIG. 13

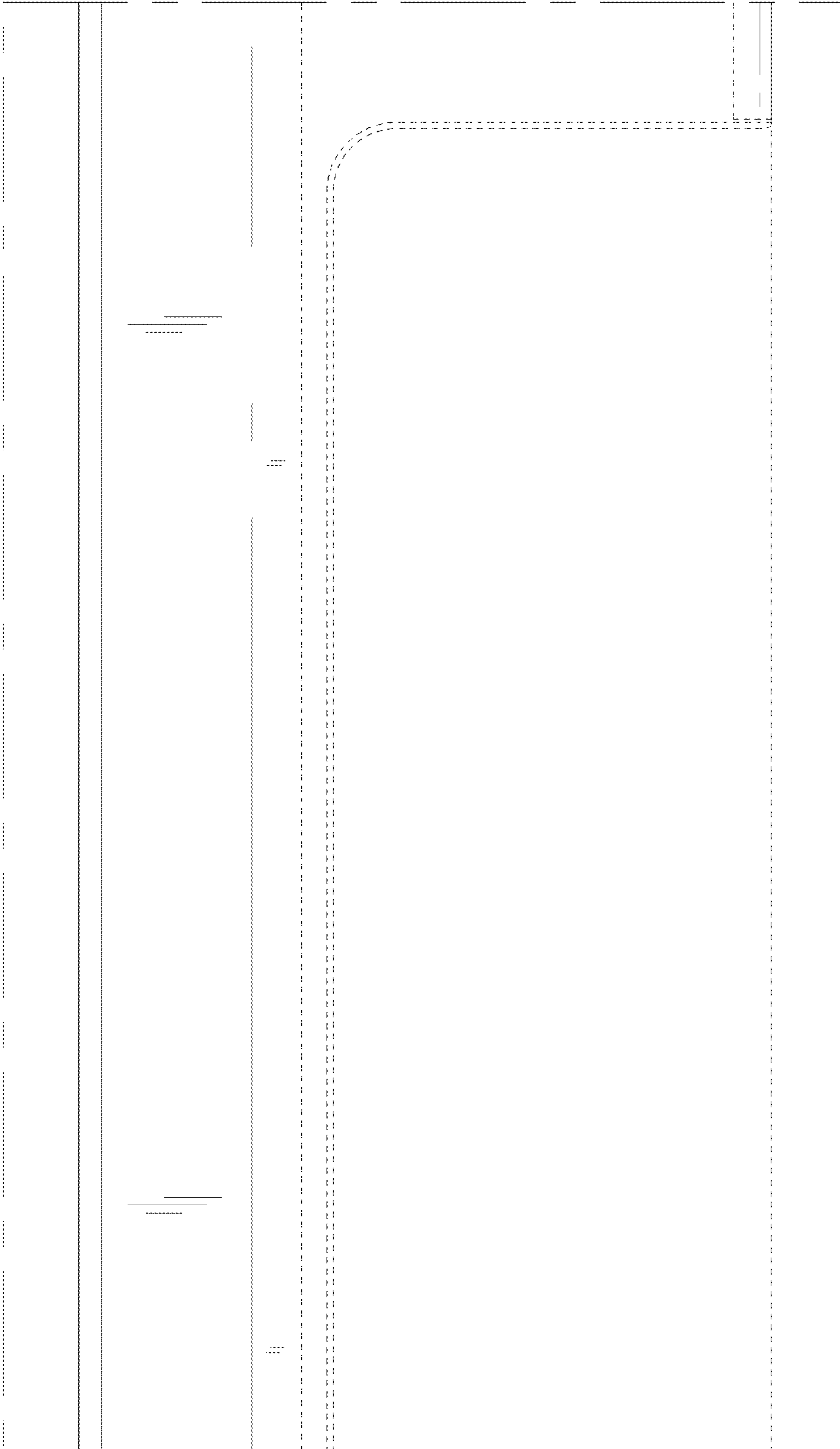

FIG. 14

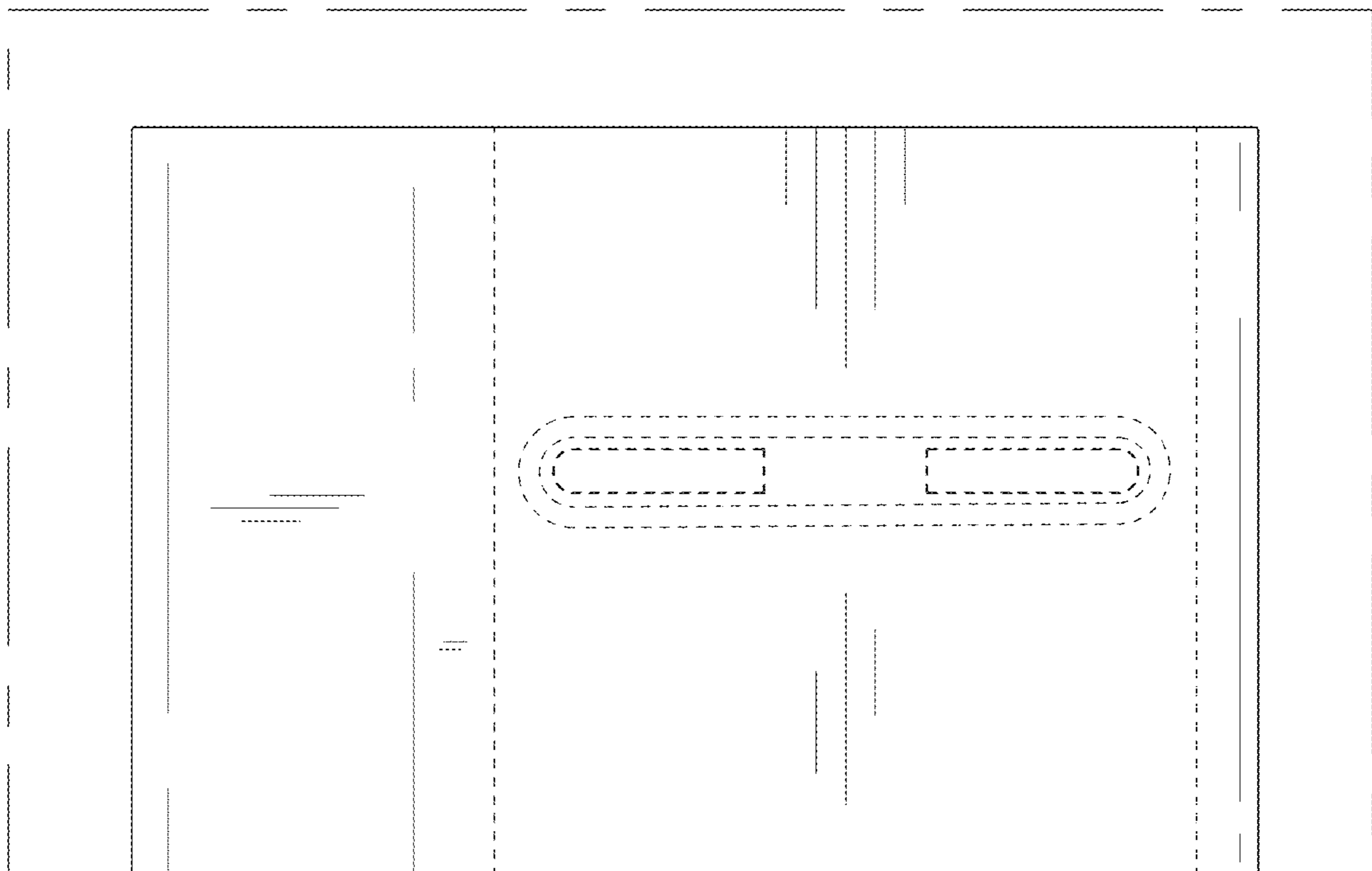



FIG. 15

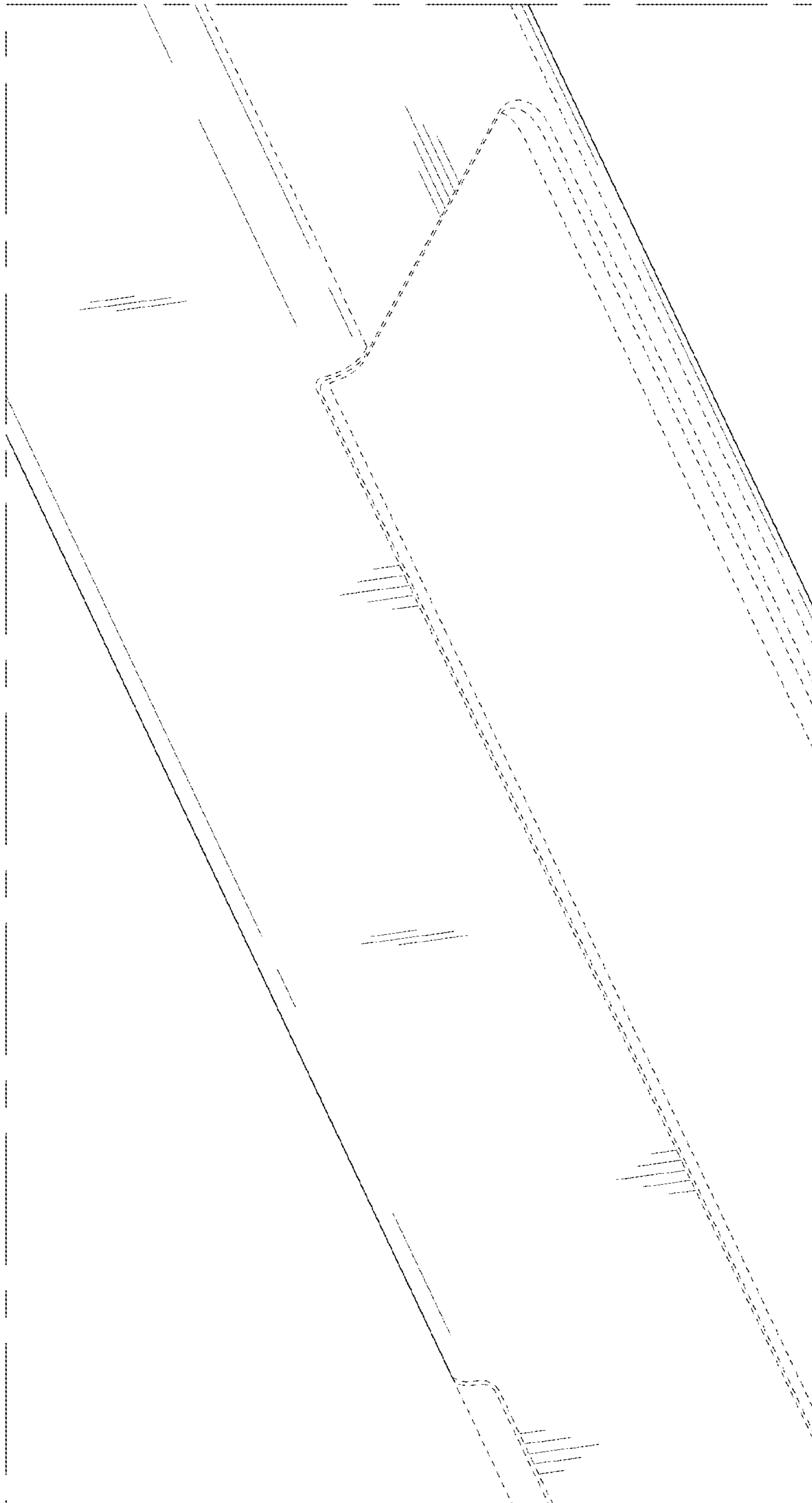

FIG. 16

