



US00D951712S

(12) **United States Design Patent** (10) **Patent No.:** **US D951,712 S**
Bodum (45) **Date of Patent:** **** May 17, 2022**

(54) **DRINKING FLASK**
(71) Applicant: **PI-Design AG**, Triengen (CH)
(72) Inventor: **Jorgen Bodum**, Meggen (CH)
(73) Assignee: **PI-DESIGN AG**
(**) Term: **15 Years**

D375,052 S * 10/1996 Lathrop D9/545
D406,062 S * 2/1999 Brewer D9/520
D422,503 S * 4/2000 Lehn D7/511
D482,607 S * 11/2003 McRae D9/443
(Continued)

(21) Appl. No.: **29/729,328**
(22) Filed: **Mar. 25, 2020**

FOREIGN PATENT DOCUMENTS

CN 302886667 * 7/2014
CN 304424681 * 12/2017
(Continued)

(30) **Foreign Application Priority Data**

Oct. 7, 2019 (WO) WIPO88135

(51) **LOC (13) Cl.** **07-01**

(52) **U.S. Cl.**
USPC **D7/510; D7/511**

(58) **Field of Classification Search**
USPC D7/507, 509, 510, 511, 523, 533, 535,
D7/536, 392.1, 396.1, 396.2, 608, 300.1,
D7/598, 600, 532, 900; D9/443, 446,
D9/449; D3/202; D29/125, 126;
220/713, 715
CPC B65D 1/40; B65D 21/086; A47G 21/18;
A47G 19/22; A47G 19/2288; A47G
19/2205; A45F 2003/205; A47J 41/0055;
A47J 41/0022; A47J 41/00; A47J
41/0077; A47J 41/0088; Y10S 220/903
See application file for complete search history.

OTHER PUBLICATIONS

HD Designs Outdoors Glass Bottle with Bamboo Lid—Jet Black,
17 oz—Kroger [online] URL: <https://www.kroger.com/p/hd-designs-outdoors-glass-bottlewith-bamboo-lid-jet-black/0004122631838?fulfillment=SHIP> (site visited: Sep. 30, 2021) (Year: 2021).*
(Continued)

Primary Examiner — Jae Liang
Assistant Examiner — Tia Ruth-Renee Polidori
(74) *Attorney, Agent, or Firm* — McDonnell Boehnen
Hulbert & Berghoff LLP

(57) **CLAIM**

The ornamental design for a drinking flask, as shown and described.

DESCRIPTION

FIG. 1 is a perspective view of a drinking flask showing my new design;
FIG. 2 is a front view thereof;
FIG. 3 is a rear view thereof;
FIG. 4 is a left side view thereof;
FIG. 5 is a right side view thereof;
FIG. 6 is a top view thereof; and,
FIG. 7 is a bottom view thereof.
The broken lines in the drawings depict portions of the drinking flask that form no part of the claimed design.

(56) **References Cited**

U.S. PATENT DOCUMENTS

D189,406 S * 12/1960 Harlow D9/443
D193,640 S * 9/1962 Deaver D7/608
D243,583 S * 3/1977 Reynolds D9/501
D279,346 S * 6/1985 Ruxton D7/321
D286,604 S * 11/1986 Bierlein D11/152
D307,648 S * 5/1990 Arrington D29/126
D337,527 S * 7/1993 Klapwald D9/449

1 Claim, 7 Drawing Sheets

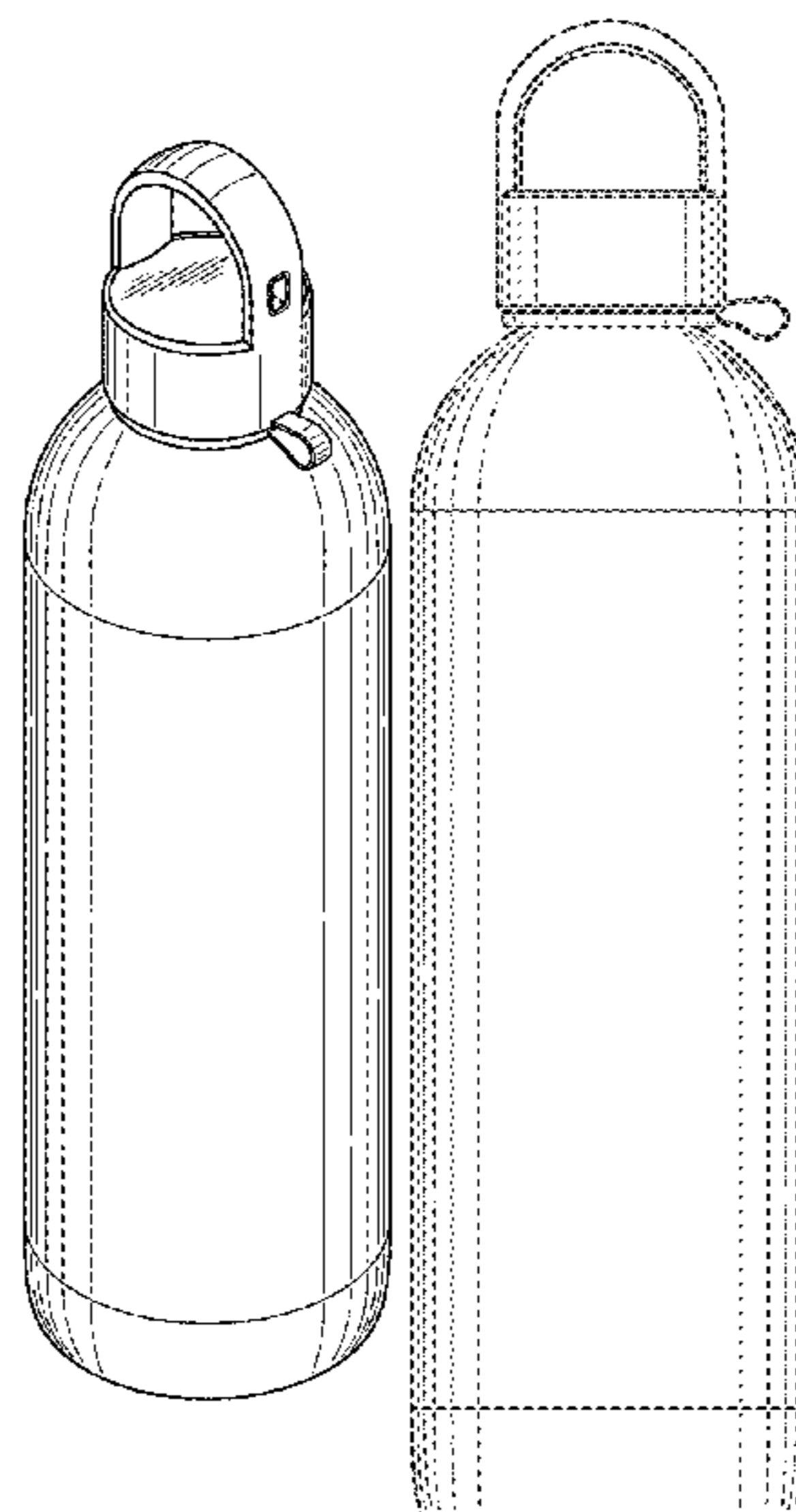

(56)

References Cited

U.S. PATENT DOCUMENTS

D627,601 S * 11/2010 Eyal D7/510
 D635,457 S * 4/2011 Lane D7/511
 D651,086 S * 12/2011 Gullickson D9/504
 8,136,686 B2 * 3/2012 Schlatter A44B 15/005
 220/212.5
 D672,238 S * 12/2012 Aziz D9/443
 D672,609 S * 12/2012 Aziz D7/510
 D675,100 S * 1/2013 Herbst D9/504
 D678,772 S * 3/2013 Johnson D9/500
 D708,954 S * 7/2014 Barnes D9/504
 D712,255 S * 9/2014 Geis D9/436
 D713,365 S * 9/2014 Green D13/183
 D716,657 S * 11/2014 Caneer D9/443
 D724,385 S * 3/2015 Hurley D7/511
 D759,902 S * 6/2016 Kim D29/125
 D805,918 S * 12/2017 Matthieu D9/500
 D806,468 S * 1/2018 Goodwin D7/392.1
 D811,818 S * 3/2018 Wu D7/510
 D812,428 S * 3/2018 Wu D7/510
 D813,613 S * 3/2018 Wall D7/608
 D814,852 S * 4/2018 Melanson D7/391
 D830,128 S * 10/2018 Rohe D7/531
 D830,773 S * 10/2018 Jacobsen D7/511
 D830,774 S * 10/2018 Jacobsen D7/511
 D830,784 S * 10/2018 Moore D7/608
 D848,265 S * 5/2019 Harris D9/500
 D851,494 S * 6/2019 Linderman D9/630
 D855,386 S * 8/2019 Tammen D7/391
 D856,809 S * 8/2019 Gruda D9/558
 D857,456 S * 8/2019 Bell D7/511
 D860,793 S * 9/2019 Cartis D9/503
 D862,228 S * 10/2019 Yao D9/443
 D865,448 S * 11/2019 Jacobsen D7/511
 D865,449 S * 11/2019 Jacobsen D7/511
 D865,450 S * 11/2019 Jacobsen D7/511
 D866,258 S * 11/2019 Jacobsen D7/511
 D866,259 S * 11/2019 Jacobsen D7/511
 D866,260 S * 11/2019 Jacobsen D7/511
 D866,261 S * 11/2019 Jacobsen D7/511
 D867,820 S * 11/2019 Jacobsen D7/511
 D868,537 S * 12/2019 Jacobsen D7/511
 10,571,324 B2 * 2/2020 Biswas G01F 23/0076
 D880,230 S * 4/2020 Jacobsen D7/396.2
 D881,649 S * 4/2020 Fleischhut D7/510
 D885,823 S * 6/2020 Ayres D7/392
 D885,836 S * 6/2020 Wang D7/510
 D893,952 S * 8/2020 Jenkins D7/510
 D895,351 S * 9/2020 Taylor D7/392.1

D906,119 S * 12/2020 Komai D9/504
 D908,433 S * 1/2021 Sapire D7/531
 D917,225 S * 4/2021 Huang D7/392.1
 D917,960 S * 5/2021 Yao D7/392
 D917,969 S * 5/2021 Eyal D7/511
 D922,829 S * 6/2021 Campbell D7/608
 D925,286 S * 7/2021 Lown D7/510
 D925,993 S * 7/2021 Volkoff D7/608
 D927,305 S * 8/2021 Chupak D9/500
 D927,306 S * 8/2021 Chupak D9/500
 D930,482 S * 9/2021 Taylor D9/531
 2012/0199548 A1 * 8/2012 Kitto B65D 55/16
 215/316
 2013/0153591 A1 * 6/2013 Grimes A01K 89/08
 220/735
 2015/0230651 A1 * 8/2015 Molayem A47J 31/0636
 99/322
 2016/0003615 A1 * 1/2016 Biswas G16H 20/10
 702/151
 2016/0318693 A1 * 11/2016 Hein B65D 51/242
 2018/0194518 A1 * 7/2018 Li B65D 1/023
 2018/0194537 A1 * 7/2018 Chan B65D 81/3881
 2018/0362221 A1 * 12/2018 Hooks B65D 81/3841
 2019/0241329 A1 * 8/2019 Kirkham B65D 47/265
 2019/0375548 A1 * 12/2019 Campbell B65D 81/3876
 2020/0172303 A1 * 6/2020 Rubino, Jr. B65D 51/248

FOREIGN PATENT DOCUMENTS

CN 304545233 * 3/2018
 CN 304735578 * 7/2018
 CN 305832837 * 6/2020
 KR 301059690.0000 * 6/2020

OTHER PUBLICATIONS

Origin 100% Borosilicate Glass Water Bottle With Protective Neoprene S—Origin Glass Co [online] URL: <https://originglassco.com/collections/faded-glass-bottles/products/originbest-bpa-free-100-borosilicate-glass-water-bottle-with-protective-neoprenesleeve-and-leak-proof-stain>(site visited: Sep. 30, 2021) (Year: 2021).*
 BODUM®—MELIOR [online] URL: <https://www.bodum.com/gb/en/12053-338bpet-10-y20-melior> (site visited: Sep. 30, 2021) (Year: 2020).*
 20 oz Modern Loop Bottles—TAL™ Hydration [online] URL: <https://talhydration.com/products/20-oz-modern-loop-bottles?variant=39684260167855> (site visited: Oct. 1, 2021) (Year: 2021).*
 PI-Design AG, U.S. Appl. No. 29/729,322, filed Mar. 25, 2020.

* cited by examiner

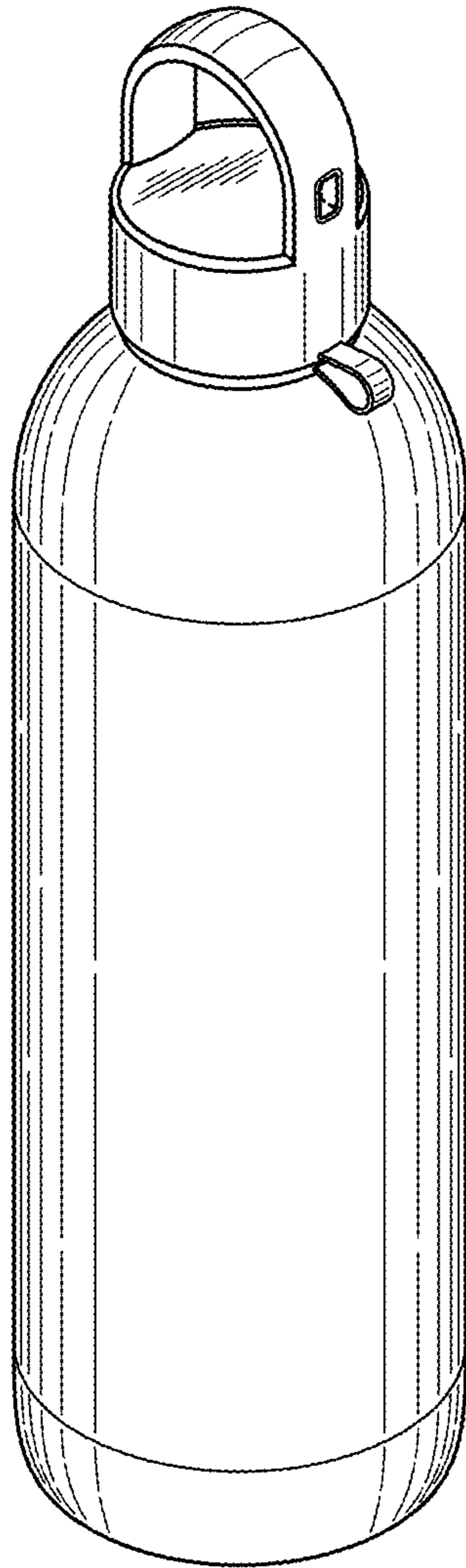

FIG. 1

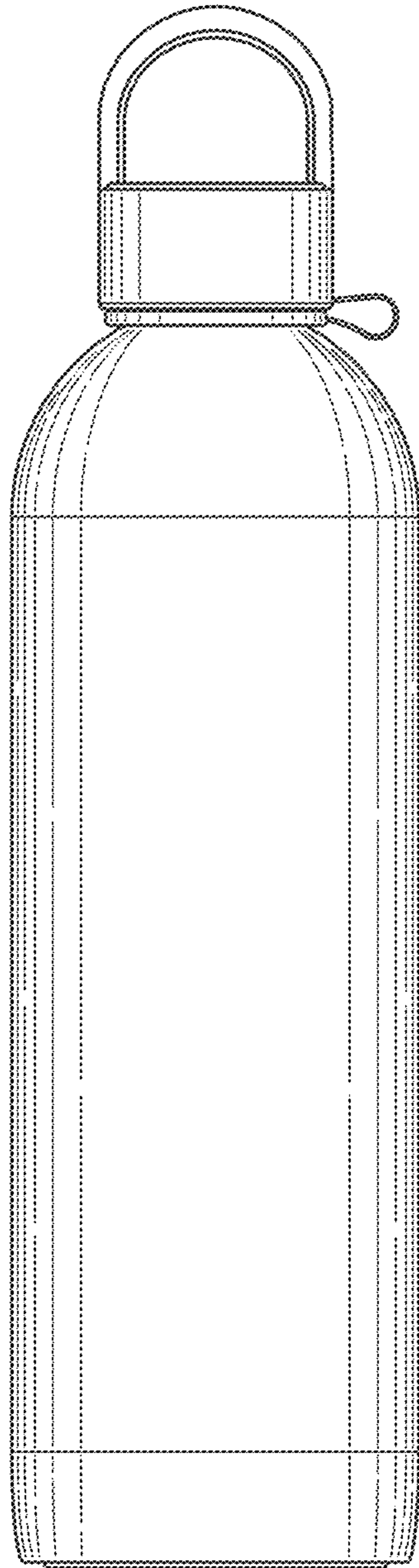

FIG. 2

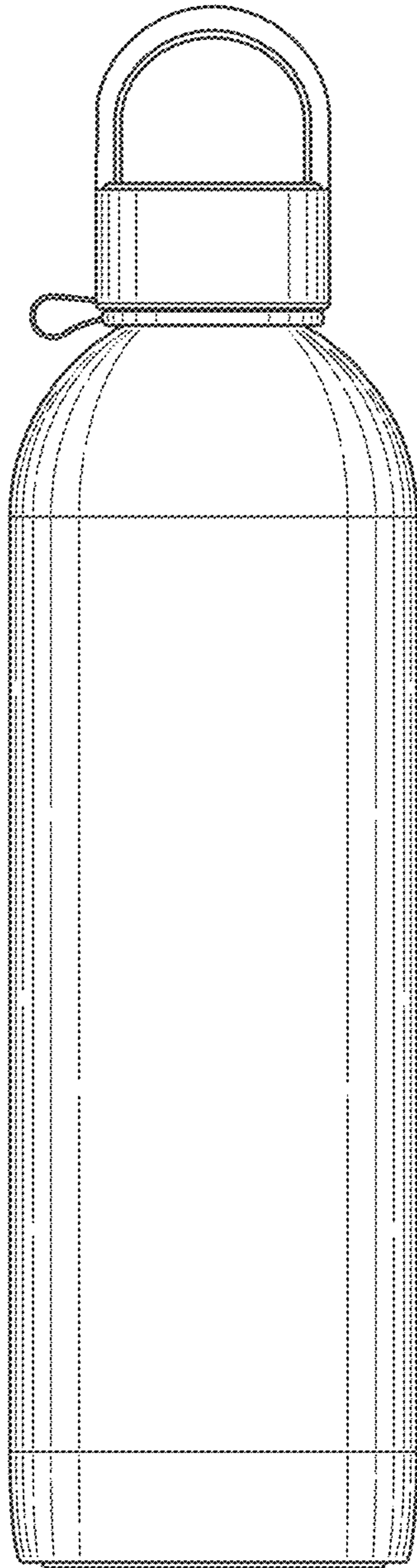

FIG. 3

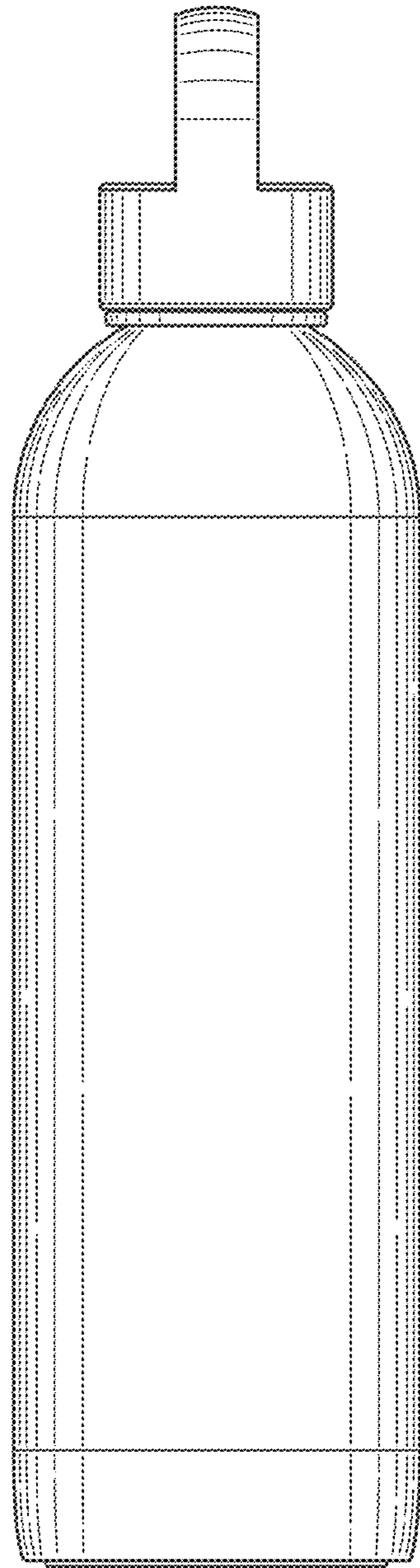

FIG. 4

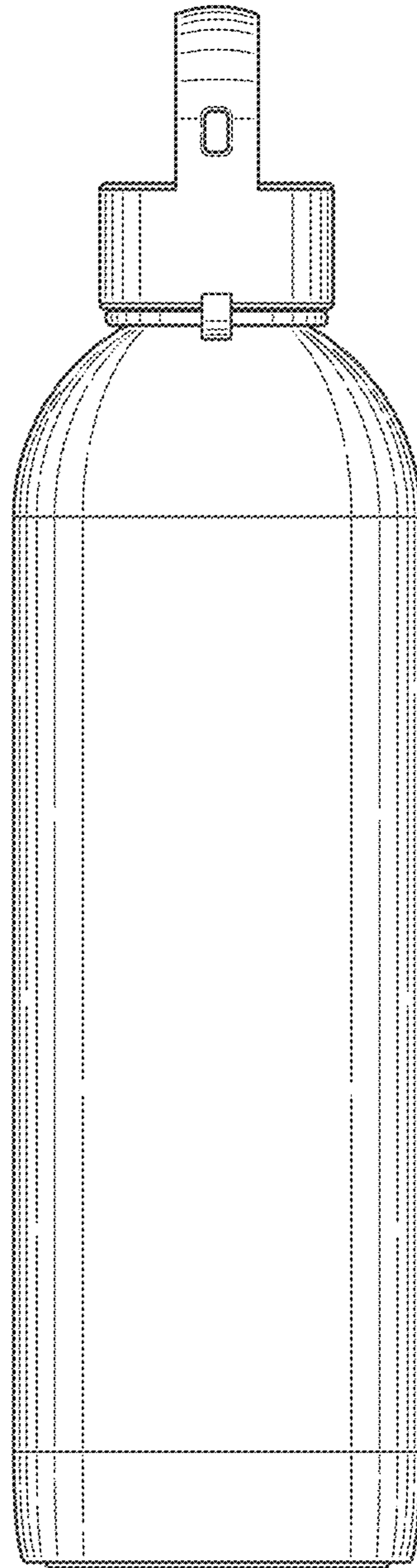

FIG. 5

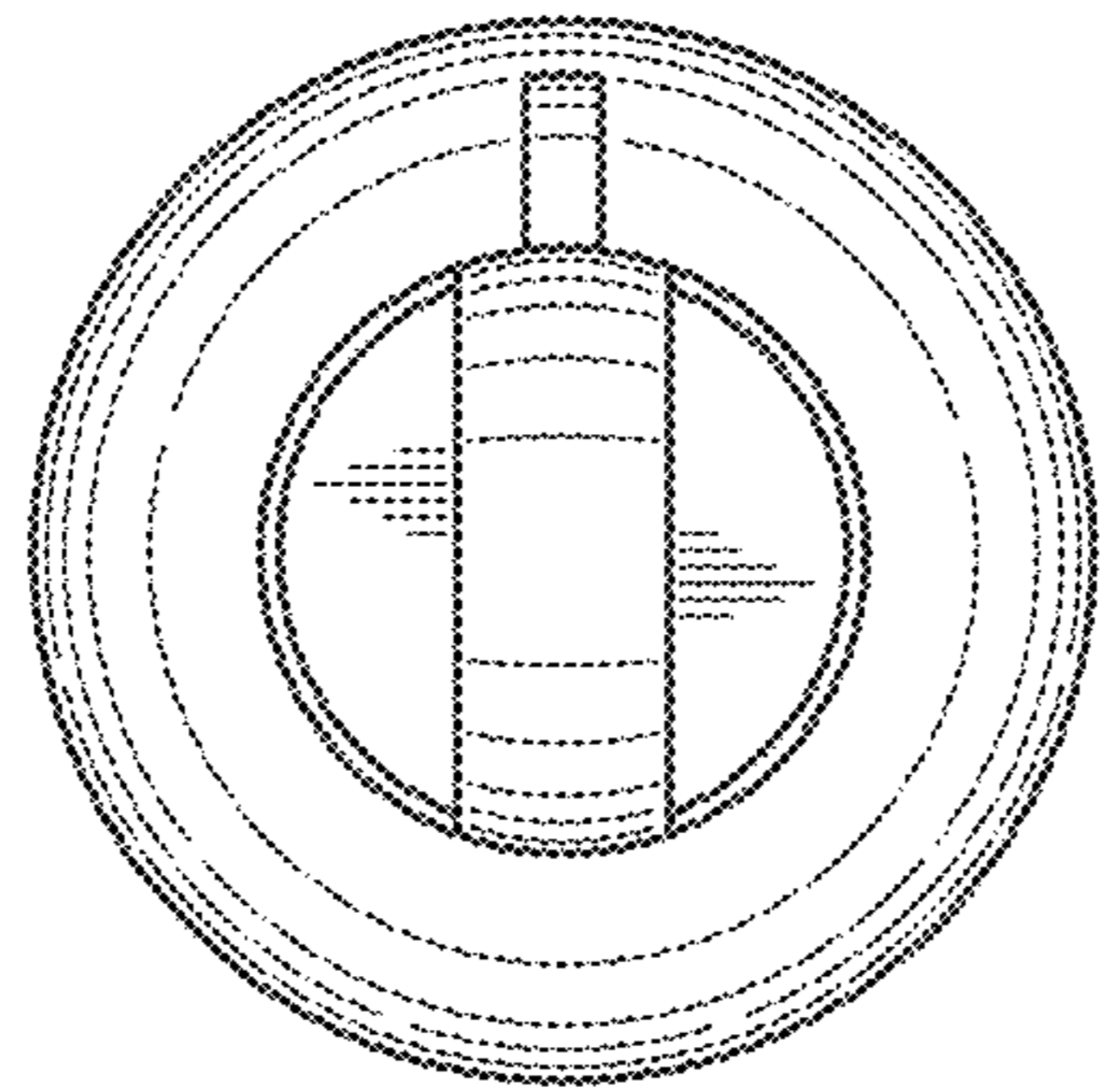

FIG. 6

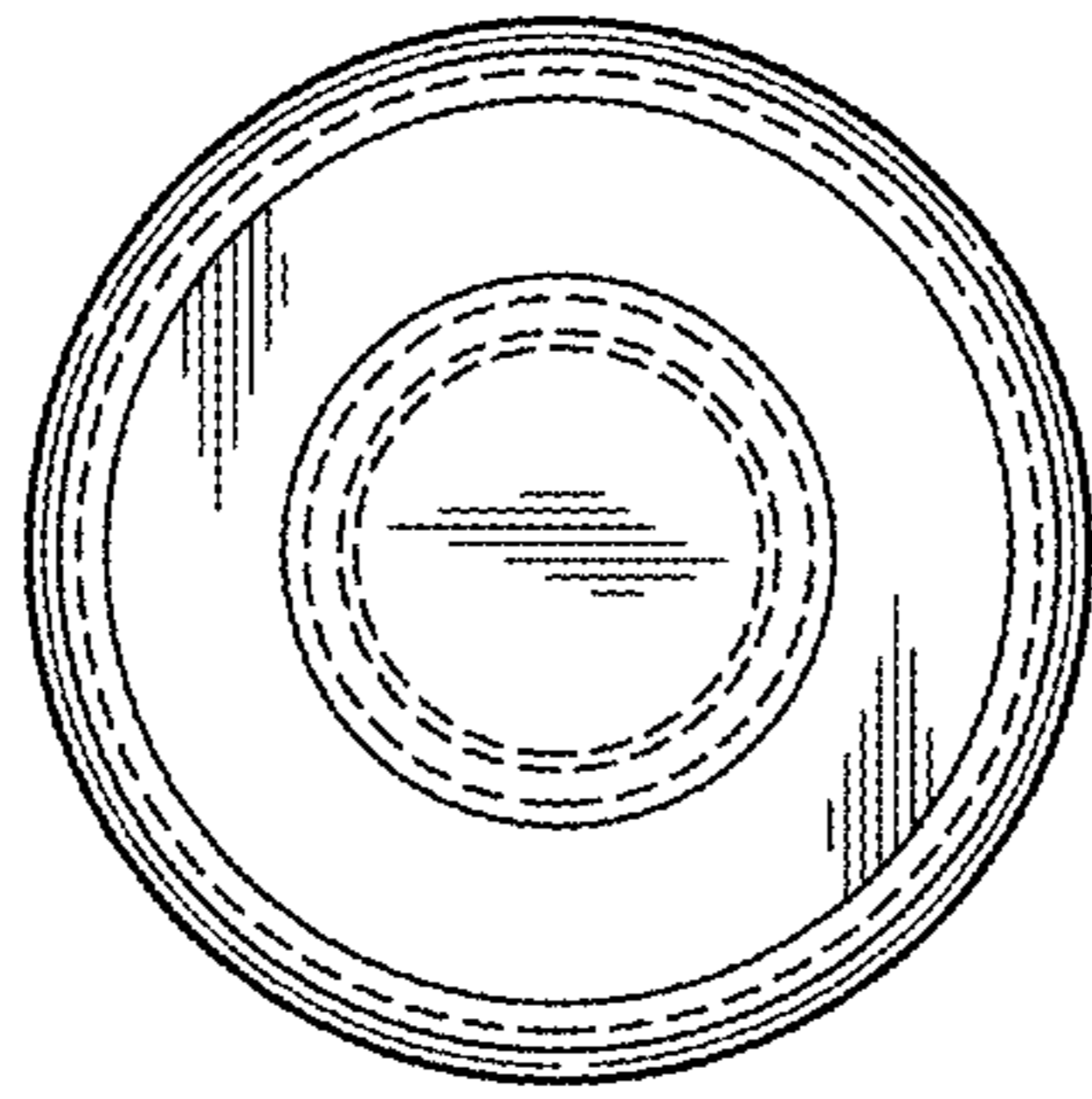

FIG. 7