



US00D951678S

(12) **United States Design Patent**
Dobin

(10) **Patent No.:** **US D951,678 S**

(45) **Date of Patent:** **** May 17, 2022**

- (54) **COVER FOR MATTRESS BOX**
- (71) Applicant: **Michael J Dobin**, Fort Lauderdale, FL (US)
- (72) Inventor: **Michael J Dobin**, Fort Lauderdale, FL (US)
- (**) Term: **15 Years**
- (21) Appl. No.: **29/722,506**
- (22) Filed: **Jan. 30, 2020**
- (51) **LOC (13) Cl.** **06-13**
- (52) **U.S. Cl.**
USPC **D6/603**
- (58) **Field of Classification Search**
USPC D6/596, 602, 603, 604, 605, 606, 610, D6/611, 616, 695.1, 695.3; D7/376, 391
CPC A45C 13/36; A45C 3/03; A45C 3/001; B60R 7/043; B60N 2/60; A47C 31/00
See application file for complete search history.

- 5,745,940 A * 5/1998 Roberts A47C 27/001
5/737
- 5,749,110 A * 5/1998 Gamble A47G 9/0292
5/493
- D437,722 S * 2/2001 Ierino D6/602
- 6,185,766 B1 2/2001 Farrugia
- 6,233,760 B1 5/2001 Cavazos
- 6,272,701 B1 8/2001 Zafiroglu
- 6,311,525 B1 11/2001 Marker et al.
- 6,499,157 B1 12/2002 McCain et al.
- 6,842,921 B1 1/2005 Tsiarkezos et al.
- 6,983,500 B2 1/2006 Wootten
- 7,051,388 B1 5/2006 Taddeo
- 7,093,310 B2 8/2006 Barros
- 7,337,480 B2 3/2008 Borino

(Continued)

Primary Examiner — Karen S Acker

(74) *Attorney, Agent, or Firm* — Derek Fahey, Esq.; The Plus IP Firm, PLLC

(57) **CLAIM**

The ornamental design for a cover for mattress box, as shown and described.

DESCRIPTION

FIG. 1 is a front top and right perspective view of a cover for mattress box;
 FIG. 2 is a front view, thereof;
 FIG. 3 is a rear view thereof;
 FIG. 4 is a right view, thereof;
 FIG. 5 is a left view, thereof;
 FIG. 6 is a top plan view, thereof;
 FIG. 7 is a bottom plan view, thereof; and,
 FIG. 8 is a rear and top perspective view of the cover for mattress box of FIG. 1.
 In FIG. 7, the cinching element of the article drawn in broken line is a portion of the cover for mattress box that forms no part of the claimed design. The area inside of the broken line depicts environmental subject matter that forms no part of the claimed design.

1 Claim, 8 Drawing Sheets

- (56) **References Cited**
U.S. PATENT DOCUMENTS
- 2,856,615 A * 10/1958 Cirocco A47C 31/105
5/500
- 3,636,575 A 1/1972 Smith
- 3,638,251 A * 2/1972 Weiss A47G 9/02
5/490
- D245,747 S * 9/1977 Ikeda D6/606
- D263,104 S * 2/1982 Stalter, Sr. D6/605
- 4,317,244 A * 3/1982 Balfour-Richie A47G 9/0246
5/500
- 4,672,702 A 6/1987 Isham
- D315,655 S * 3/1991 White D6/603
- 5,046,207 A 9/1991 Chamberlain
- 5,127,115 A 7/1992 Williams et al.
- 5,247,893 A 9/1993 Zafiroglu
- 5,287,574 A 2/1994 Kardell et al.
- 5,621,931 A 4/1997 Hamilton

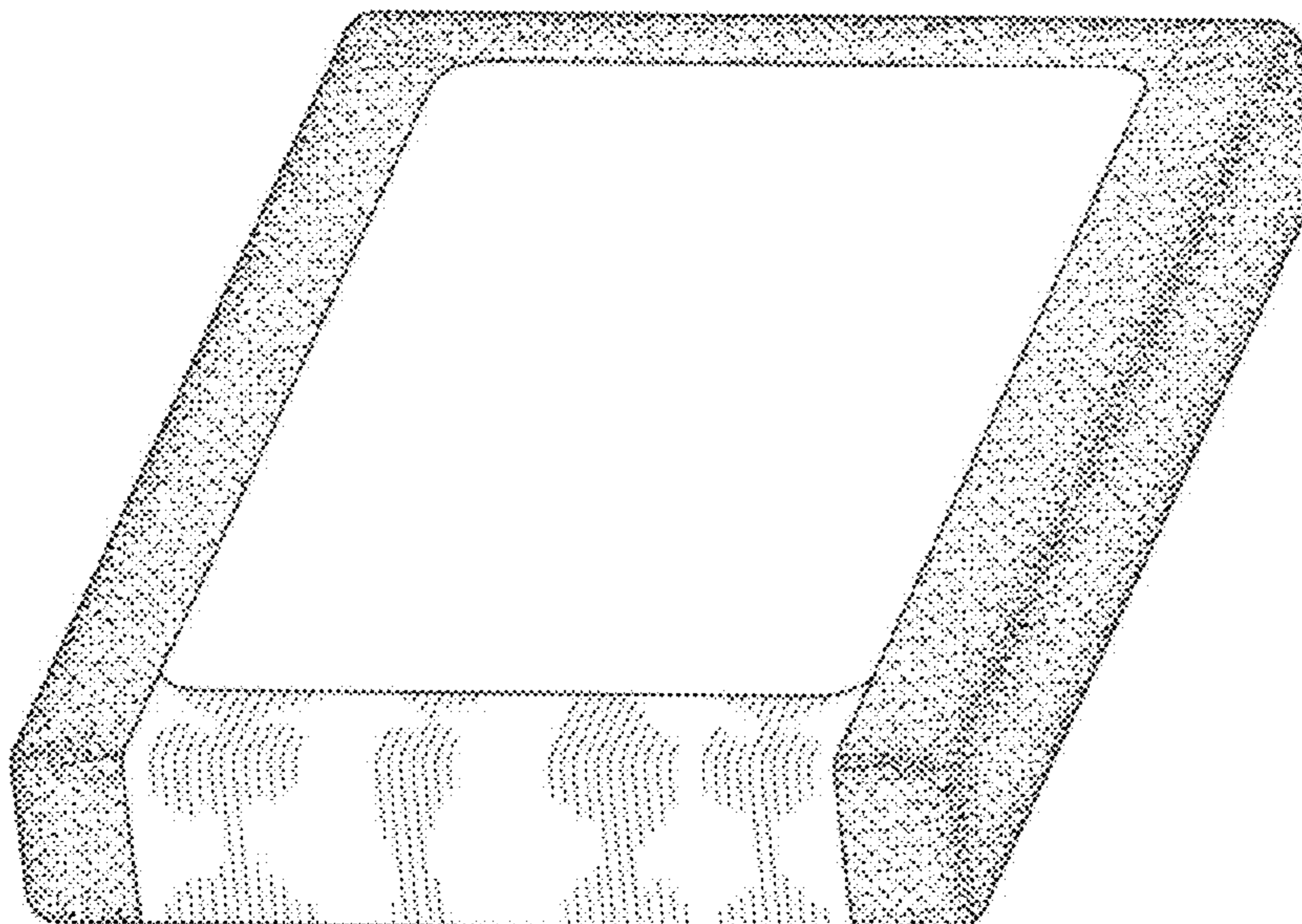

(56)

References Cited

U.S. PATENT DOCUMENTS

7,398,570 B2 7/2008 Seago
 D577,532 S * 9/2008 Deeble A47G 9/04
 D6/610
 D598,231 S * 8/2009 Thompson A47G 9/0246
 D6/602
 7,849,532 B1 12/2010 Servais
 D630,878 S * 1/2011 Kennett A47C 7/021
 D6/603
 D634,148 S * 3/2011 Morrison D6/605
 7,930,779 B2 * 4/2011 Marrache A47C 27/005
 5/500
 D657,157 S * 4/2012 Shih A47C 27/001
 D6/392
 8,171,581 B2 * 5/2012 Agarwall A47G 9/0246
 5/482
 8,607,383 B2 * 12/2013 Briganti A47G 9/0246
 5/497
 8,640,282 B2 2/2014 Maguire et al.
 D704,478 S * 5/2014 Arnold D6/605
 8,997,280 B1 4/2015 Hannula
 9,138,060 B2 * 9/2015 Vainberg A47C 7/021
 9,167,919 B2 * 10/2015 Walker A47G 9/0246
 9,179,783 B2 11/2015 Snell et al.
 D753,935 S * 4/2016 Driffield D6/606
 D770,811 S * 11/2016 Garrahy D6/606
 D773,209 S * 12/2016 Jaigobin D6/602

D806,442 S * 1/2018 Alletto, Jr. D6/605
 D811,777 S * 3/2018 Wightman D6/606
 D830,729 S * 10/2018 Alletto, Jr. D6/596
 10,098,485 B2 10/2018 Hannula
 D862,125 S * 10/2019 Jensen D6/606
 10,624,475 B2 * 4/2020 Holt A47G 9/04
 D897,743 S * 10/2020 Xu D6/606
 10,888,182 B2 * 1/2021 Young-Loaeza A47G 9/0246
 D922,100 S * 6/2021 Oshin D6/606
 D927,891 S * 8/2021 Petzold D6/606
 11,166,567 B2 * 11/2021 Roshberg A47C 27/002
 2004/0040090 A1 * 3/2004 Wootten A47G 9/0246
 5/497
 2004/0139547 A1 * 7/2004 Wootten, Jr. A47C 21/022
 5/497
 2004/0226089 A1 11/2004 Miranda
 2005/0011007 A1 1/2005 Lintner
 2008/0028522 A1 * 2/2008 Atwood A47G 9/0246
 5/497
 2011/0314604 A1 * 12/2011 Hoo A47G 9/0246
 5/497
 2012/0066835 A1 3/2012 Kelly et al.
 2013/0042411 A1 2/2013 Vitale
 2015/0074907 A1 3/2015 Skaggs
 2016/0073798 A1 3/2016 Pawlikowski et al.
 2018/0192782 A1 * 7/2018 Fischer A47C 27/008
 2018/0279795 A1 * 10/2018 Murphy A47C 27/002
 2018/0360227 A1 * 12/2018 Martin D04H 3/011

* cited by examiner

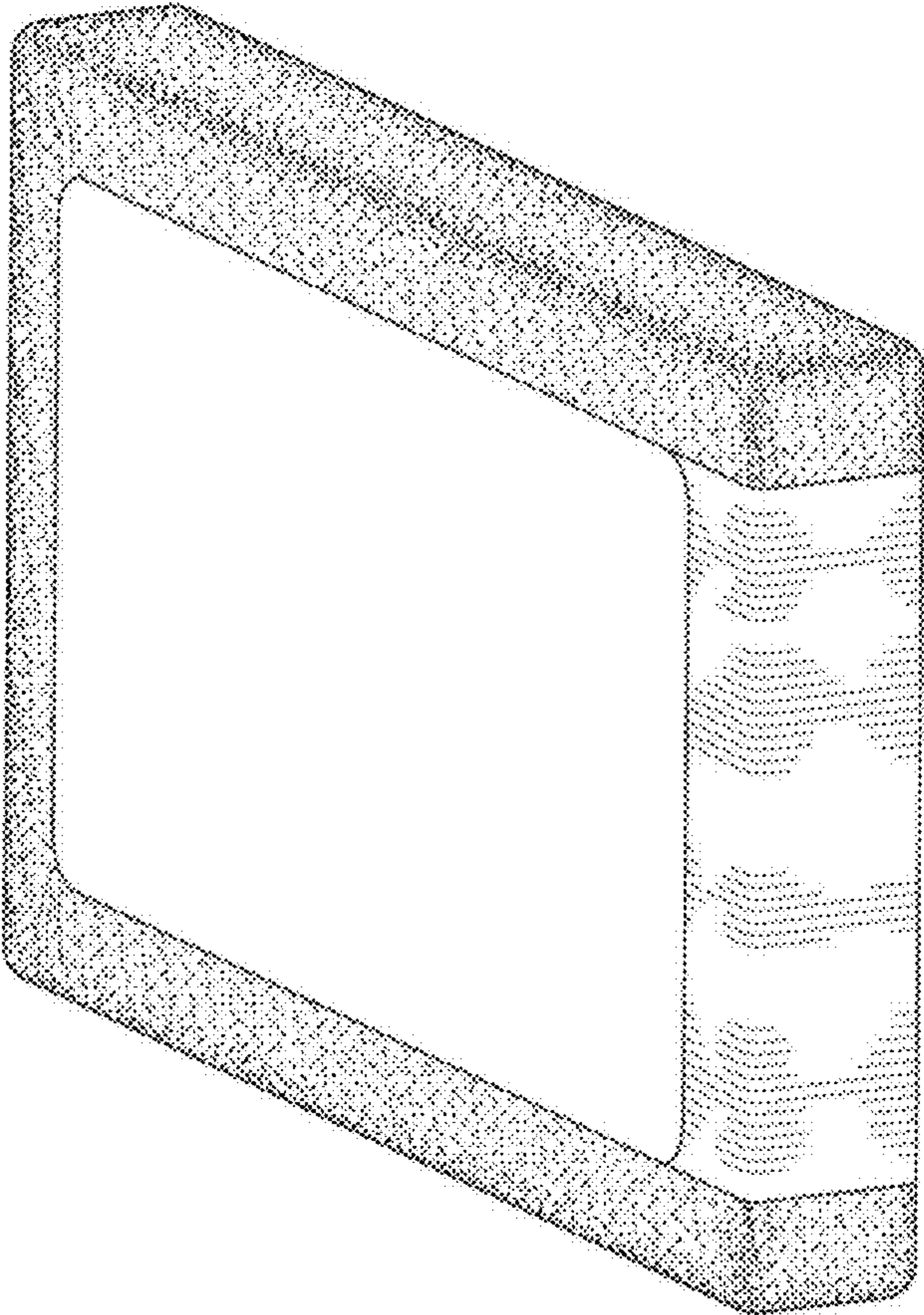

FIG. 1

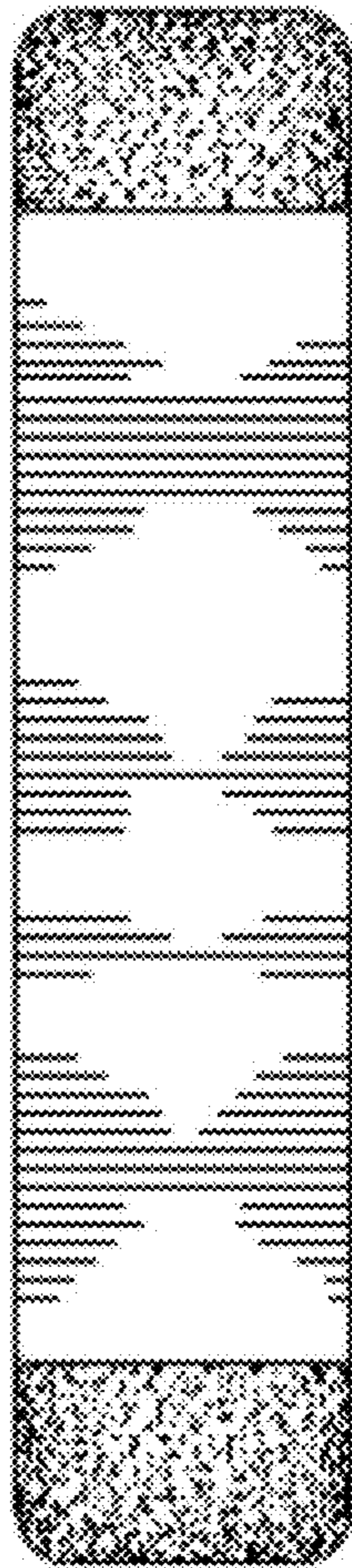

FIG. 2

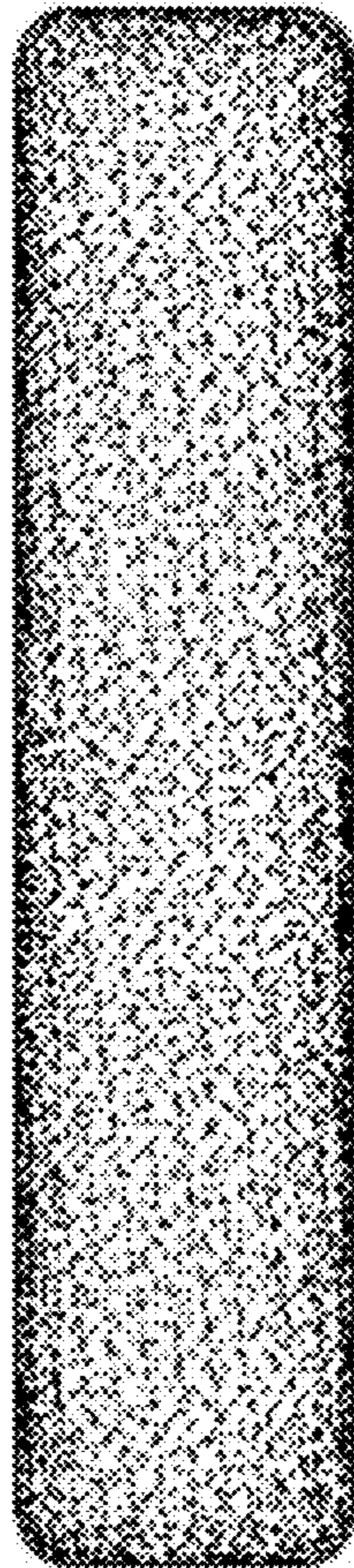

FIG. 3

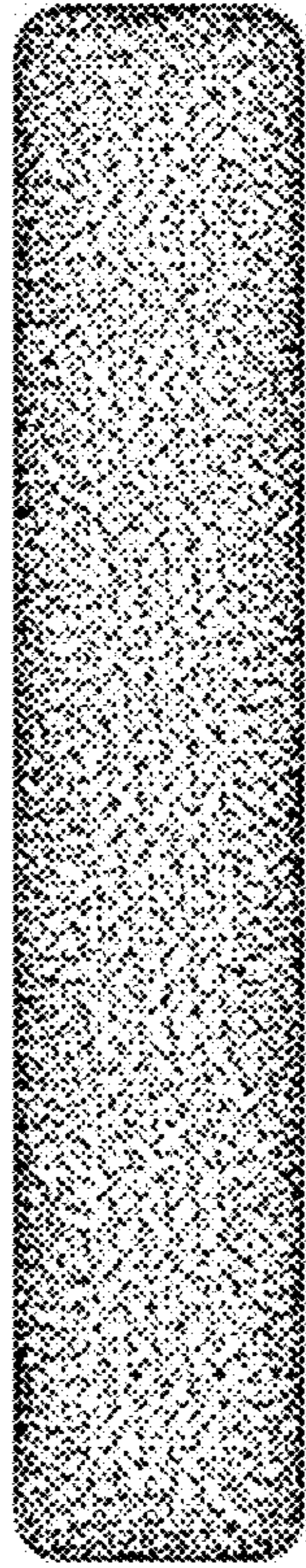

FIG. 4

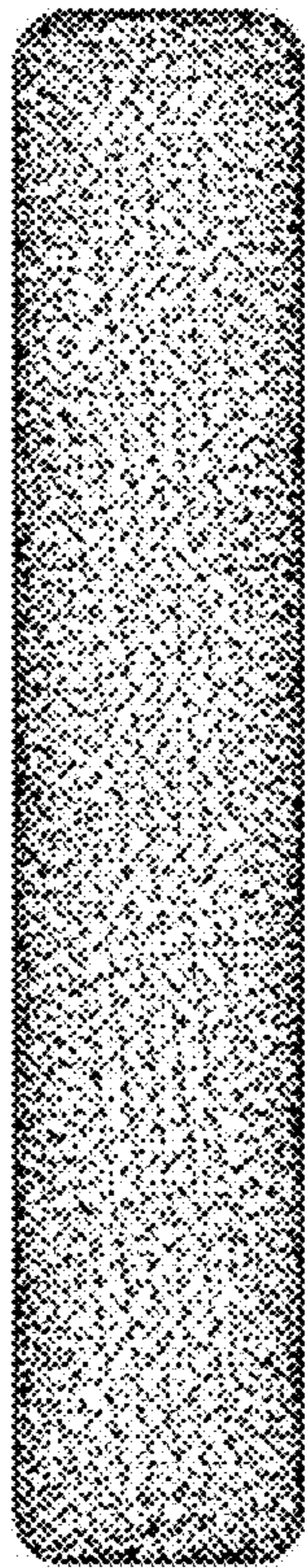

FIG. 5

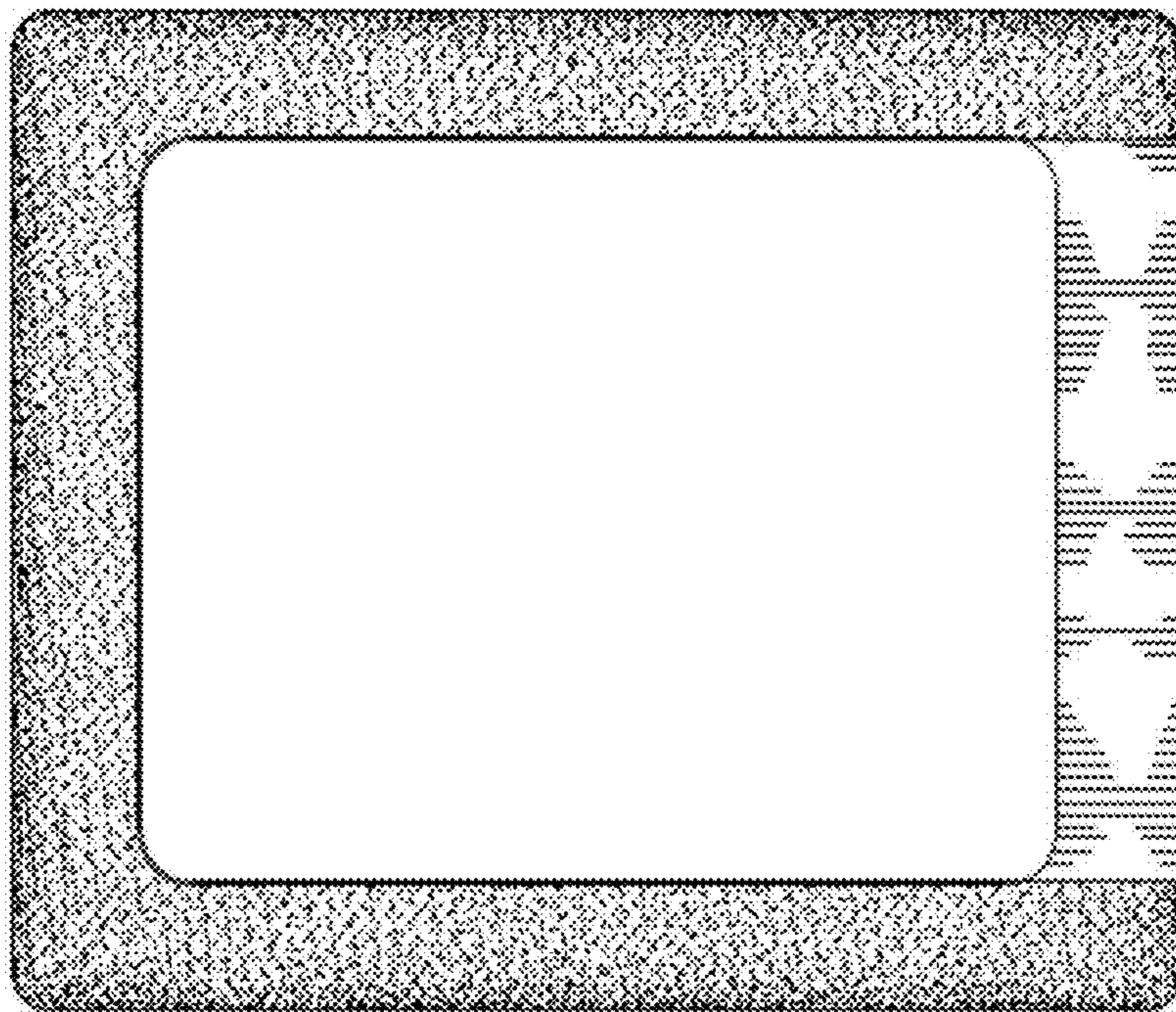

FIG. 6

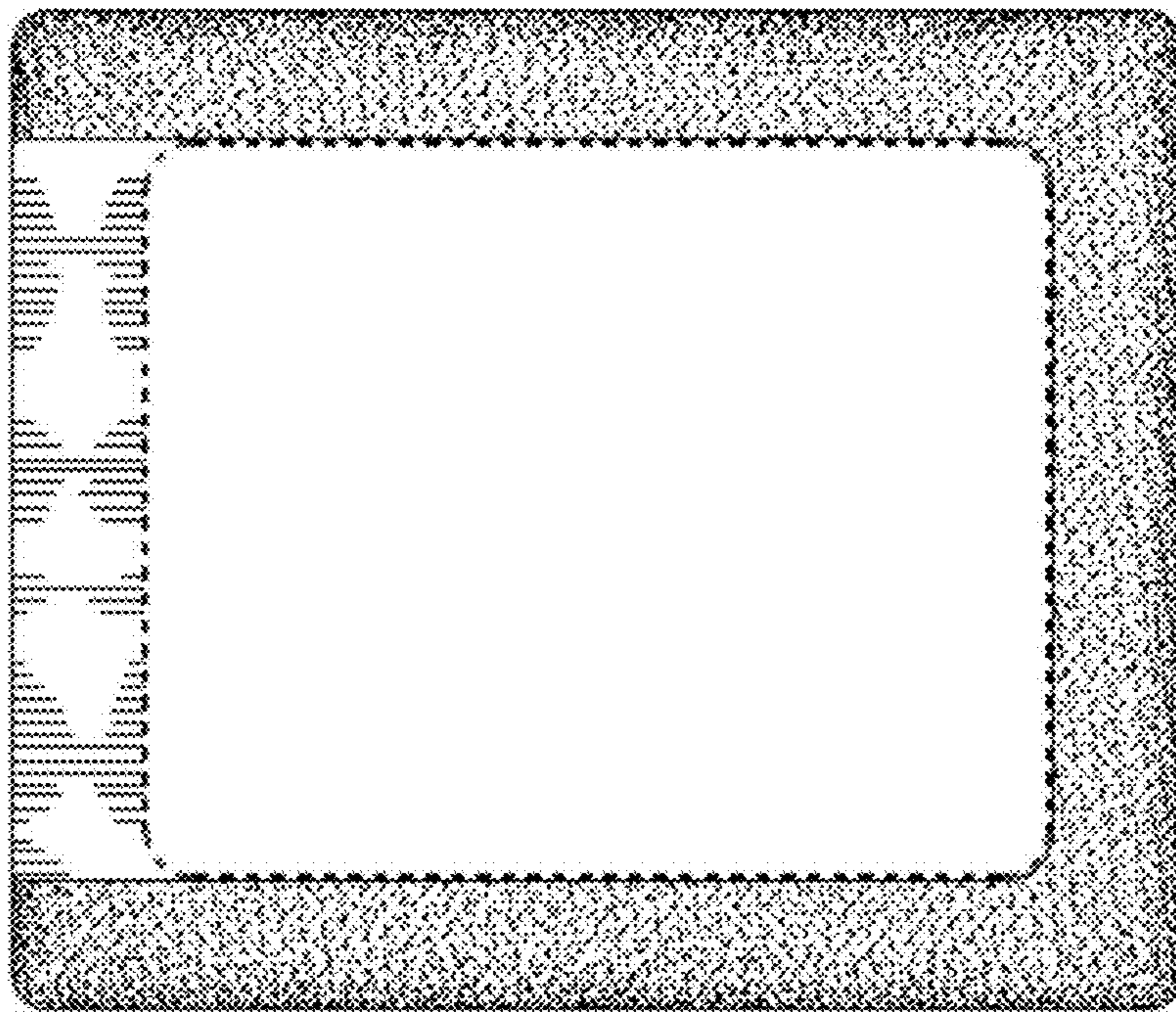

FIG. 7

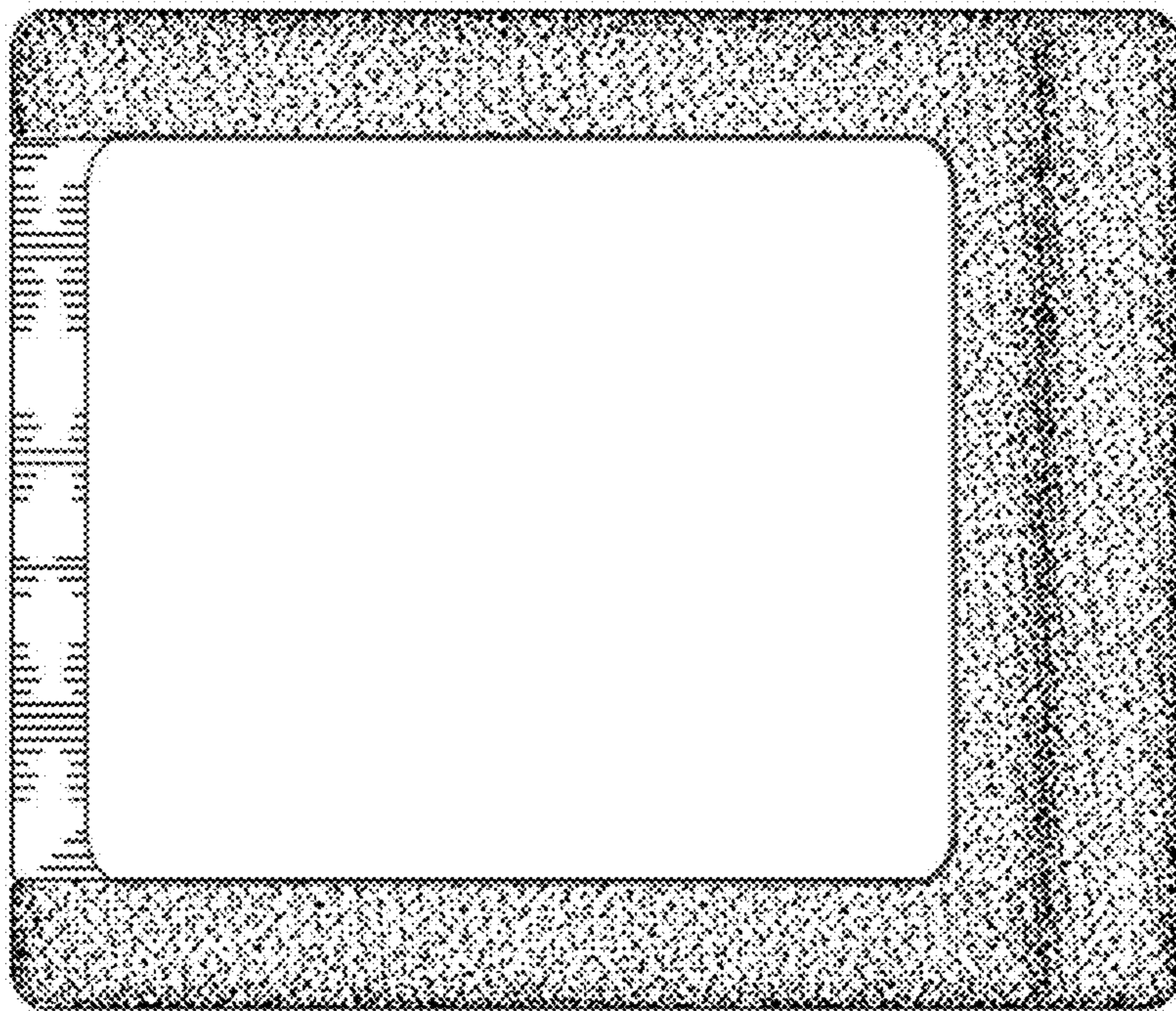

FIG. 8