



US00D951677S

(12) **United States Design Patent** (10) **Patent No.:** **US D951,677 S**
Cohen (45) **Date of Patent:** **** May 17, 2022**

(54) **KNEELING PAD**

(71) Applicant: **RED Creations Group, Inc.**, Panama (PA)

(72) Inventor: **Tal Cohen**, Panama (PA)

(73) Assignee: **RED Creations Group, Inc.**, Panama (PA)

(**) Term: **15 Years**

(21) Appl. No.: **29/798,972**

(22) Filed: **Jul. 12, 2021**

Related U.S. Application Data

(63) Continuation of application No. 29/610,281, filed on Jul. 11, 2017, now Pat. No. Des. 924,598.

(51) **LOC (13) Cl.** **06-09**

(52) **U.S. Cl.**
USPC **D6/601**

(58) **Field of Classification Search**
USPC D6/349, 375, 512, 595, 596, 601, 604,
D6/611, 715, 716, 716.1; D21/803, 804,
(Continued)

(56) **References Cited**

U.S. PATENT DOCUMENTS

3,323,151 A * 6/1967 Lerman A47C 7/425
5/722
3,346,877 A * 10/1967 Zirves A41D 13/0568
2/24

(Continued)

FOREIGN PATENT DOCUMENTS

FR 2884694 A3 * 10/2006 A61G 7/0755

Primary Examiner — Jennifer L Rempfer

(74) *Attorney, Agent, or Firm* — K&L Gates LLP

(57) **CLAIM**

The ornamental design for a kneeling pad, as shown and described.

DESCRIPTION

FIG. 1 is a perspective view of an embodiment of a kneeling pad showing my new design;
FIG. 2 is a front view thereof;
FIG. 3 is a back view thereof;
FIG. 4 is a top view thereof;
FIG. 5 is a bottom view thereof;
FIG. 6 is a right side view thereof;
FIG. 7 is a left side view thereof;
FIG. 8 is a perspective view of an alternative embodiment of the kneeling pad;
FIG. 9 is a front view thereof;
FIG. 10 is a back view thereof;
FIG. 11 is a top view thereof;
FIG. 12 is a bottom view thereof;
FIG. 13 is a right side view thereof;
FIG. 14 is a left side view thereof;
FIG. 15 is a perspective view of another embodiment of the kneeling pad;
FIG. 16 is a front view thereof;
FIG. 17 is a back view thereof;
FIG. 18 is a top view thereof;
FIG. 19 is a bottom view thereof;
FIG. 20 is a right side view thereof;
FIG. 21 is a left side view thereof;
FIG. 22 is a perspective view of another embodiment of the kneeling pad;
FIG. 23 is a front view thereof;
FIG. 24 is a back view thereof;
FIG. 25 is a top view thereof;
FIG. 26 is a bottom view thereof;
FIG. 27 is a right side view thereof; and,
FIG. 28 is a left side view thereof.

The broken lines shown in the drawings represent portions of the kneeling pad that form no part of the claimed design.

1 Claim, 20 Drawing Sheets

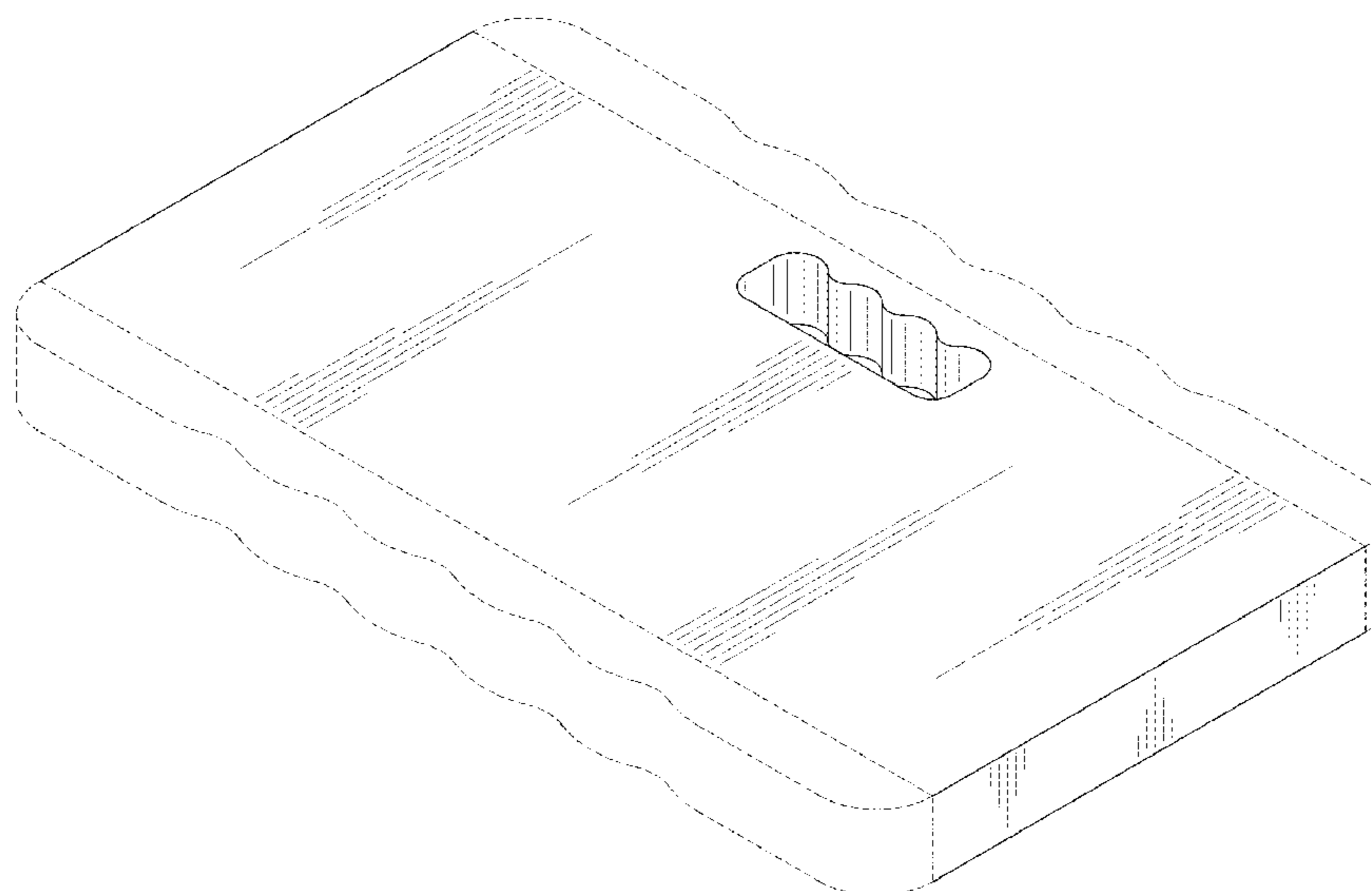

US D951,677 S

(58) **Field of Classification Search**
 USPC D21/805, 809; D24/183–185, 234;
 D19/88, 113; D9/418, 456, 457; D7/698
 CPC A61G 2205/00; A61G 13/121; A61G
 13/122; A61G 2203/70; A61G 67/047;
 A61G 67/0575; A47J 45/00; A47J 47/005
 See application file for complete search history.

(56) **References Cited**

U.S. PATENT DOCUMENTS

D255,966 S 7/1980 Stadel
 D256,535 S 8/1980 Martin
 D260,125 S 8/1981 Rogers
 4,789,046 A * 12/1988 McDowall E04F 21/24
 182/230
 D303,466 S 9/1989 Haggerty et al.
 D311,108 S 10/1990 Farley
 D316,202 S 4/1991 Farley
 D318,392 S 7/1991 Edelson
 D337,684 S 7/1993 Kaufman et al.
 D345,072 S 3/1994 Rose et al.
 D346,924 S 5/1994 Gehry
 D346,926 S 5/1994 Sullivan
 D347,541 S 6/1994 Cook
 D364,464 S 11/1995 Gigante et al.
 D366,380 S 1/1996 Kelly
 D369,055 S 4/1996 Bode
 D375,863 S 11/1996 Bigolin
 5,572,758 A * 11/1996 Merritt A47C 7/021
 5/653
 D377,130 S * 1/1997 Dorrer D6/596
 D381,543 S 7/1997 Farley
 D381,564 S * 7/1997 Kolada D7/698
 D383,349 S 9/1997 Steelman et al.
 D388,651 S 1/1998 Graebe et al.
 D391,111 S 2/1998 Graebe et al.
 D394,366 S 5/1998 Graebe et al.
 D403,193 S 12/1998 Felter, Jr. et al.
 D406,210 S 3/1999 Johnson
 D413,037 S * 8/1999 Bellington D6/596
 D433,861 S 11/2000 Rose et al.
 D444,918 S * 7/2001 Suter D29/100
 D446,071 S 8/2001 Hawkins et al.
 D447,850 S * 9/2001 Escobedo D99/25
 D495,016 S * 8/2004 Nudo D21/318
 D505,041 S 5/2005 Lesosky

7,249,747 B2 * 7/2007 Marceau A47B 23/002
 108/43
 D550,016 S 9/2007 Boutin
 D550,017 S 9/2007 Boutin
 D553,411 S 10/2007 Boutin
 D557,045 S * 12/2007 Faber D3/274
 D566,448 S 4/2008 Ridder
 D584,911 S 1/2009 Hisey et al.
 D604,550 S 11/2009 Carter
 D622,483 S * 8/2010 Stein D2/826
 D622,995 S * 9/2010 Beraha D6/595
 D643,125 S 8/2011 Seidel
 D652,664 S 1/2012 Nickerson
 D655,558 S 3/2012 Koplin
 D697,770 S * 8/2014 Khuu D7/698
 D759,401 S * 6/2016 Richards D6/596
 D765,201 S 8/2016 Gibson
 D804,346 S * 12/2017 Barnes D10/109.1
 D823,395 S * 7/2018 McWilliam D20/27
 D824,697 S 8/2018 Ferm et al.
 D835,424 S 12/2018 Fu
 D841,819 S 2/2019 Clark et al.
 D854,353 S 7/2019 Xiang et al.
 D911,656 S * 2/2021 Baker D34/27
 D924,598 S * 7/2021 Cohen D6/601
 D928,532 S 8/2021 Thrasher
 D933,396 S * 10/2021 Jones D6/601
 2002/0096811 A1 * 7/2002 Callsen F16F 1/37
 267/145
 2003/0067105 A1 * 4/2003 Chen A47J 47/005
 269/289 R
 2004/0194218 A1 * 10/2004 Hayes F03G 3/00
 5/695
 2007/0000005 A1 * 1/2007 Wang A41D 13/065
 2/24
 2007/0087916 A1 * 4/2007 McCarter A63B 23/0233
 482/96
 2010/0052229 A1 * 3/2010 Baur, IV A47C 16/04
 267/142
 2011/0118088 A1 * 5/2011 Caya A63B 21/154
 482/51
 2013/0111643 A1 * 5/2013 Moffat A47C 16/02
 2/24
 2015/0306802 A1 * 10/2015 Thoma B29C 65/565
 428/166
 2016/0242554 A1 * 8/2016 Schoen A47C 16/04
 2016/0262464 A1 * 9/2016 Hatfield A45F 5/021

* cited by examiner

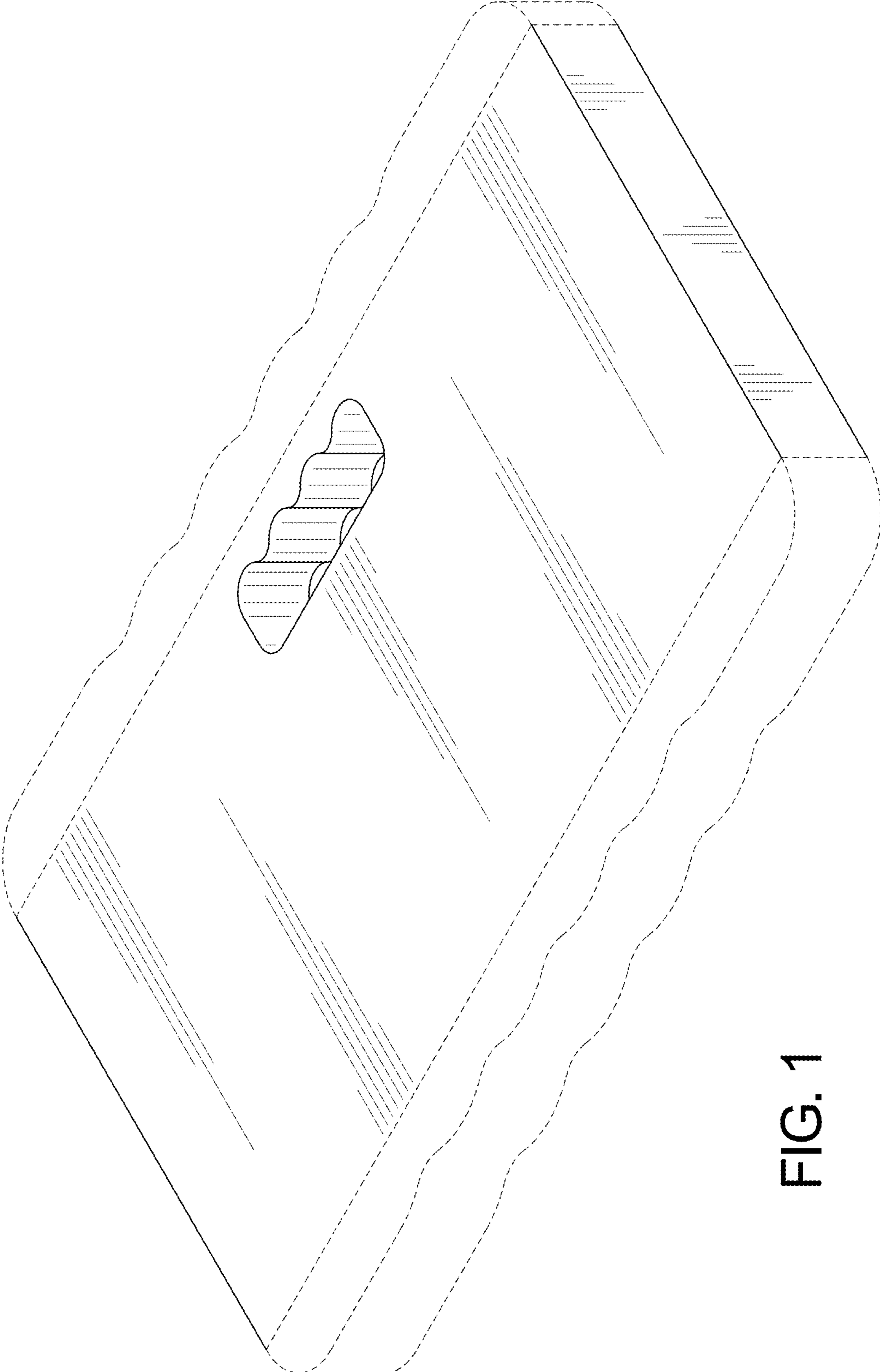

FIG. 1

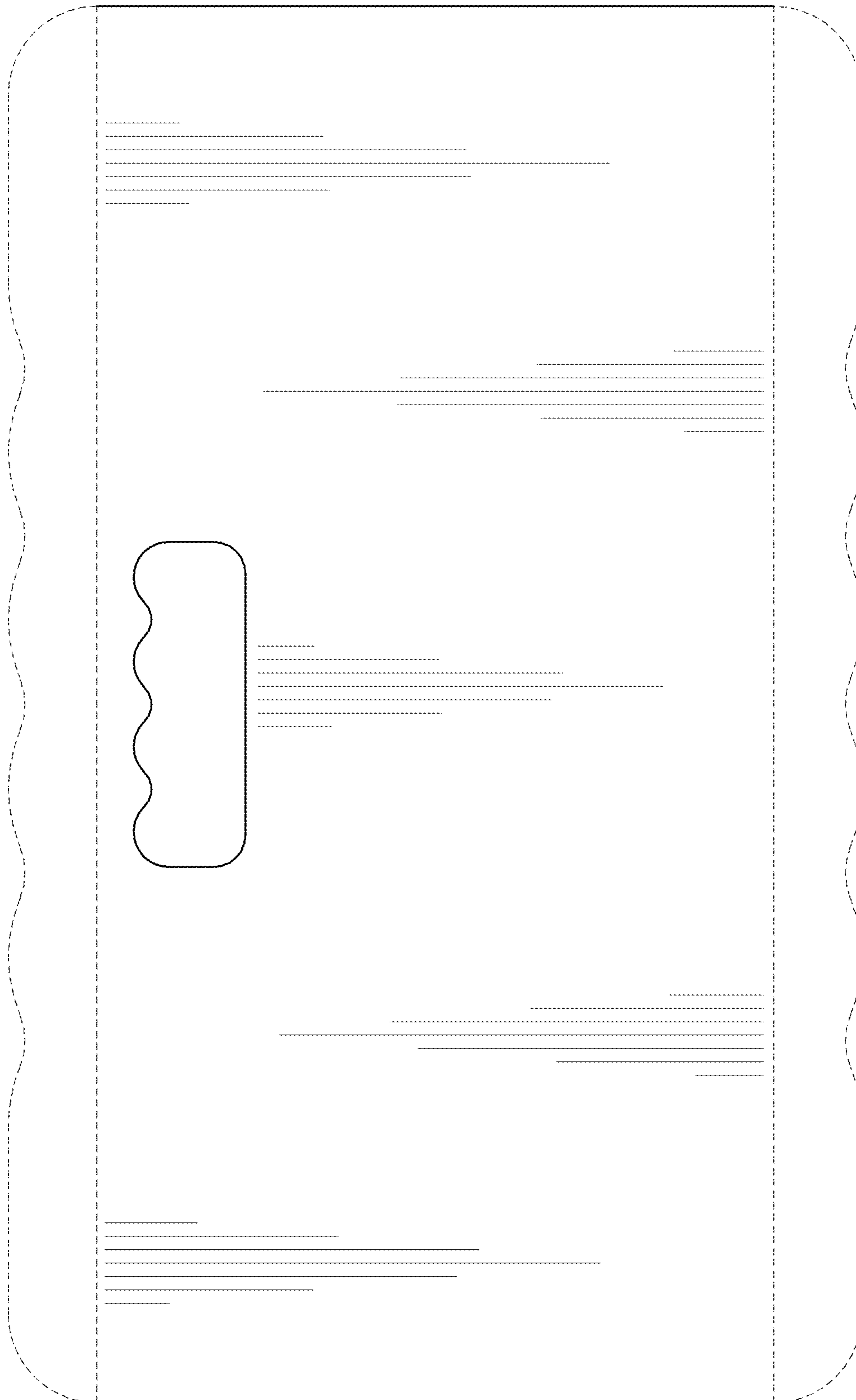

FIG. 2

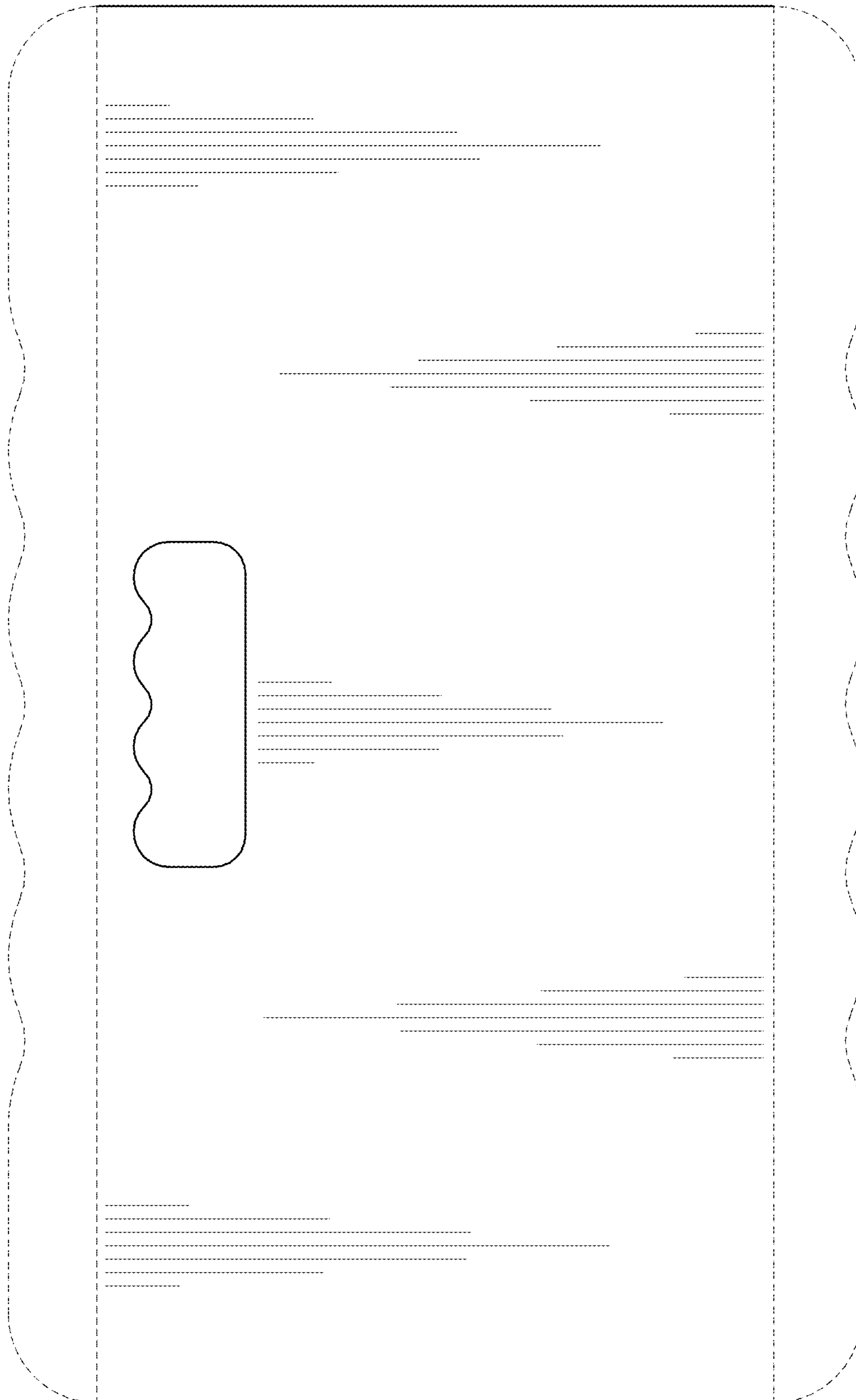

FIG. 3

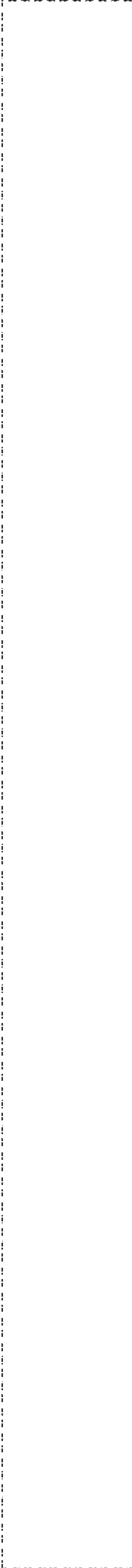

FIG. 4



FIG. 5

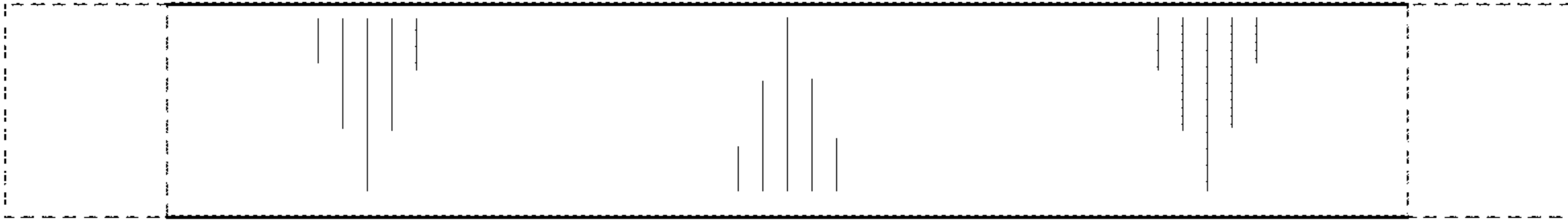

FIG. 7

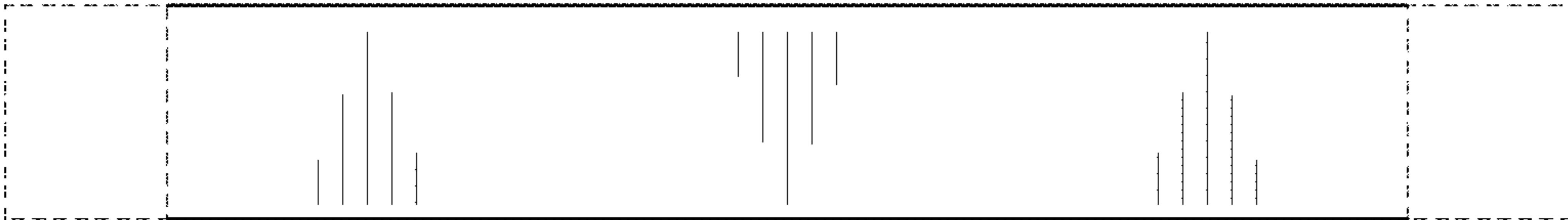

FIG. 6

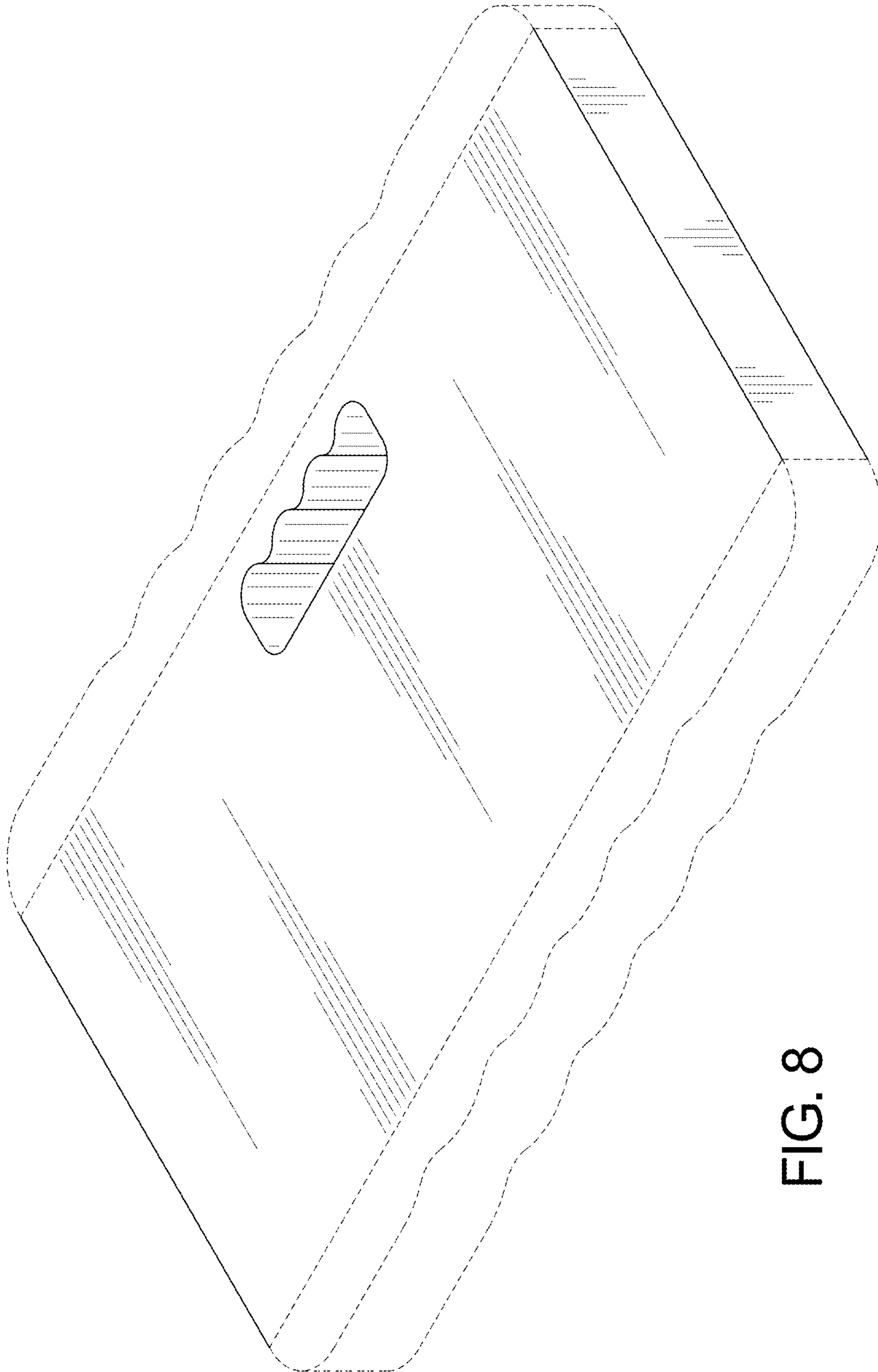

FIG. 8

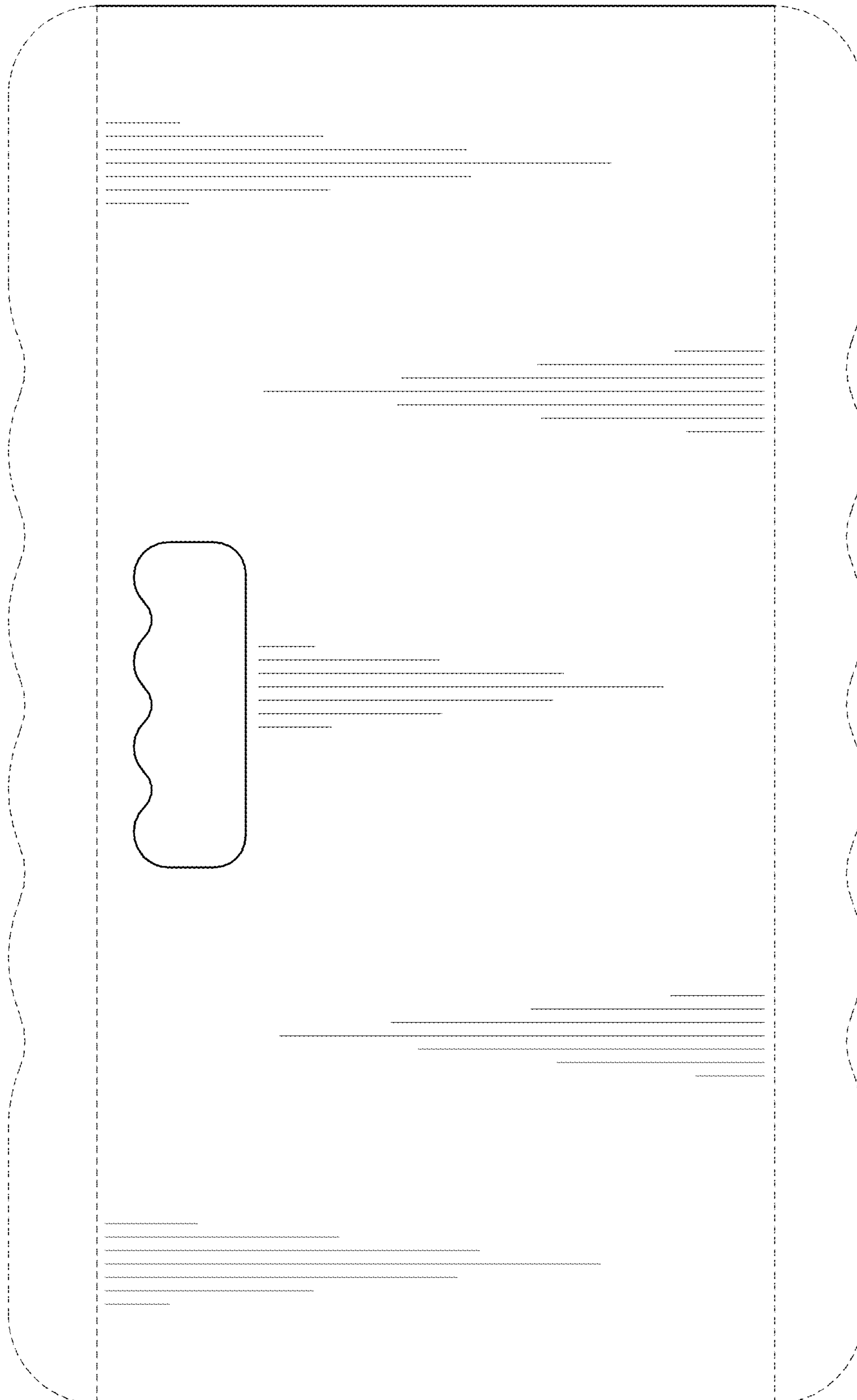

FIG. 9

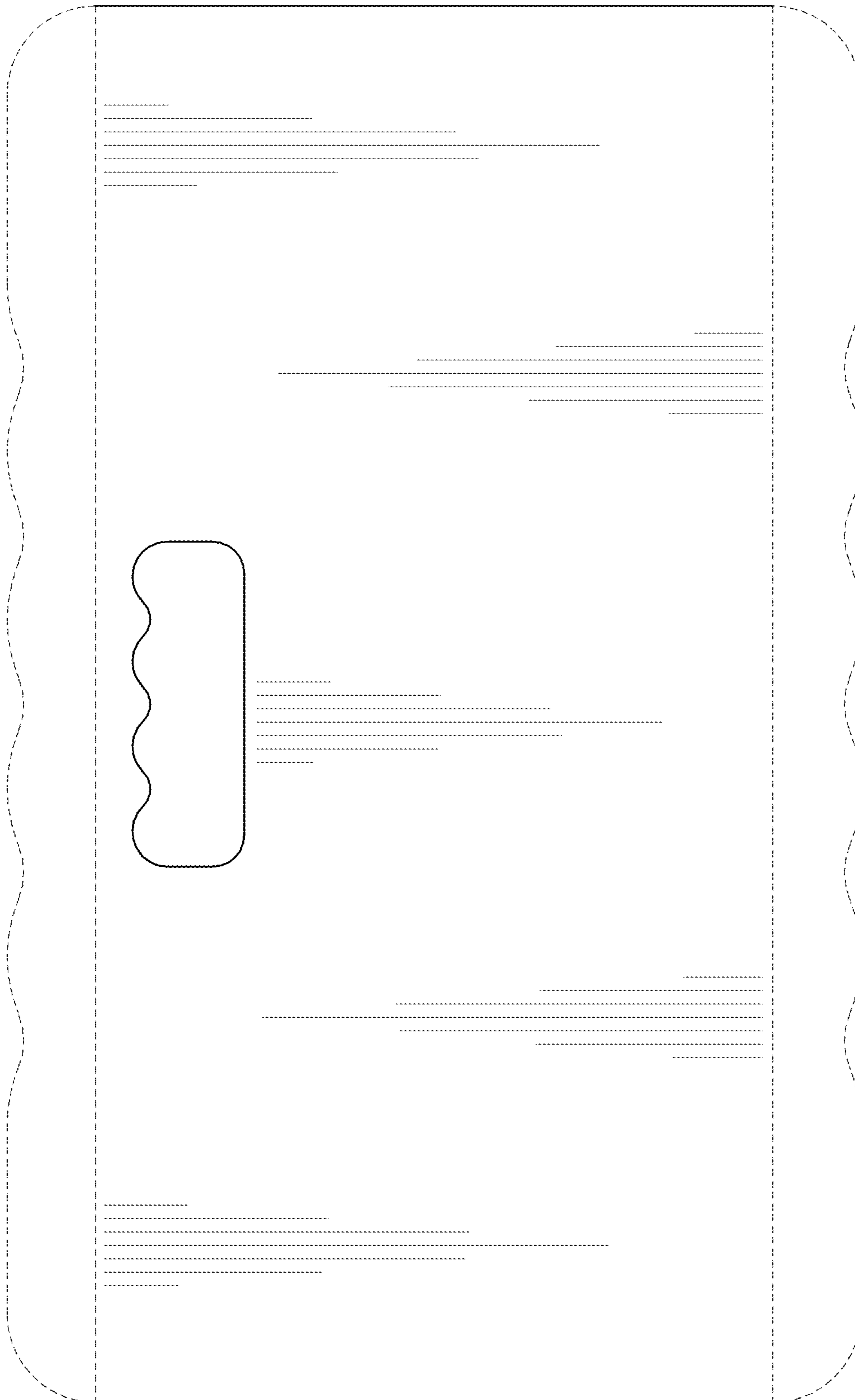

FIG. 10

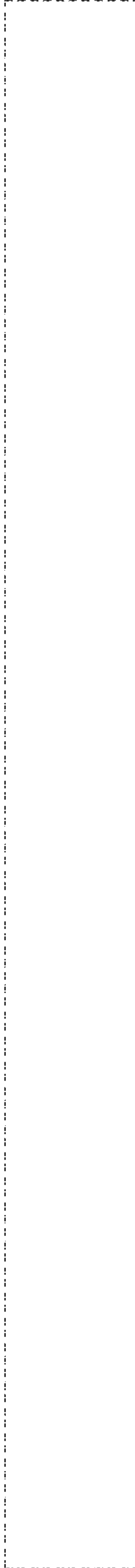

FIG. 11

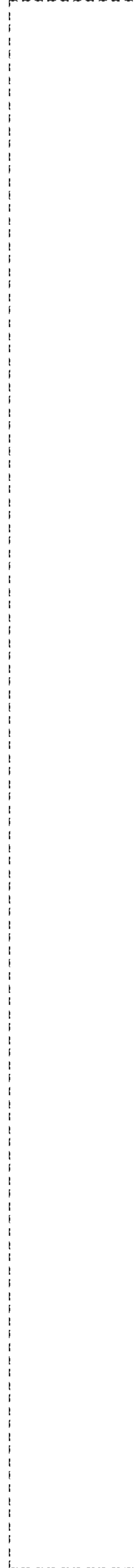

FIG. 12

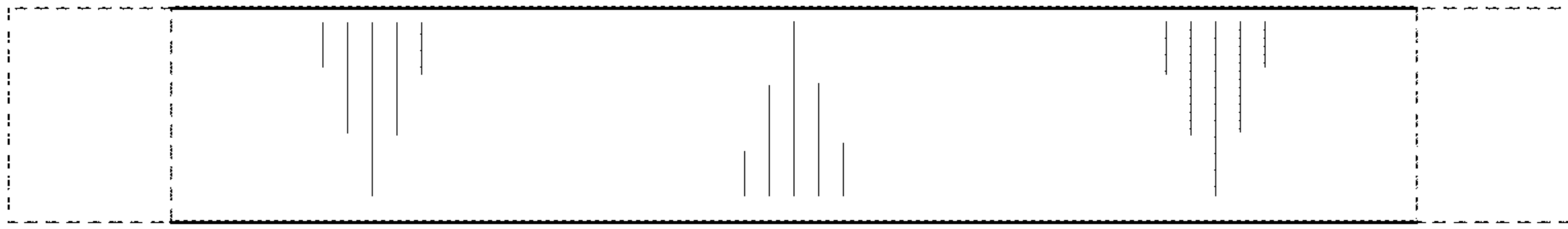

FIG. 14

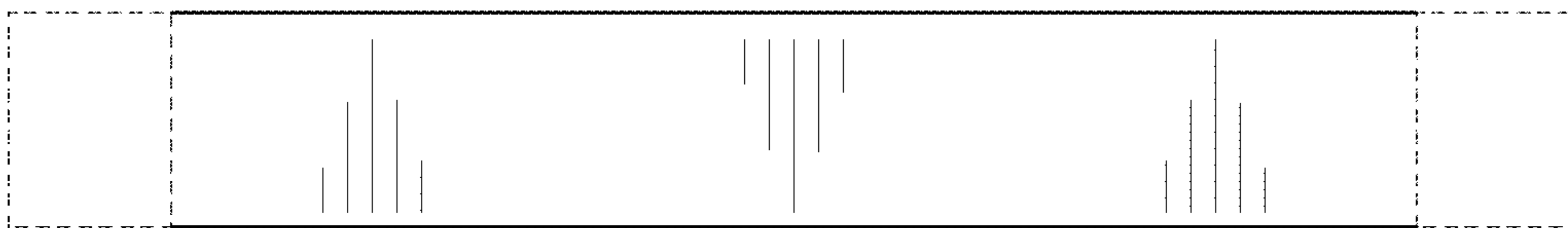

FIG. 13

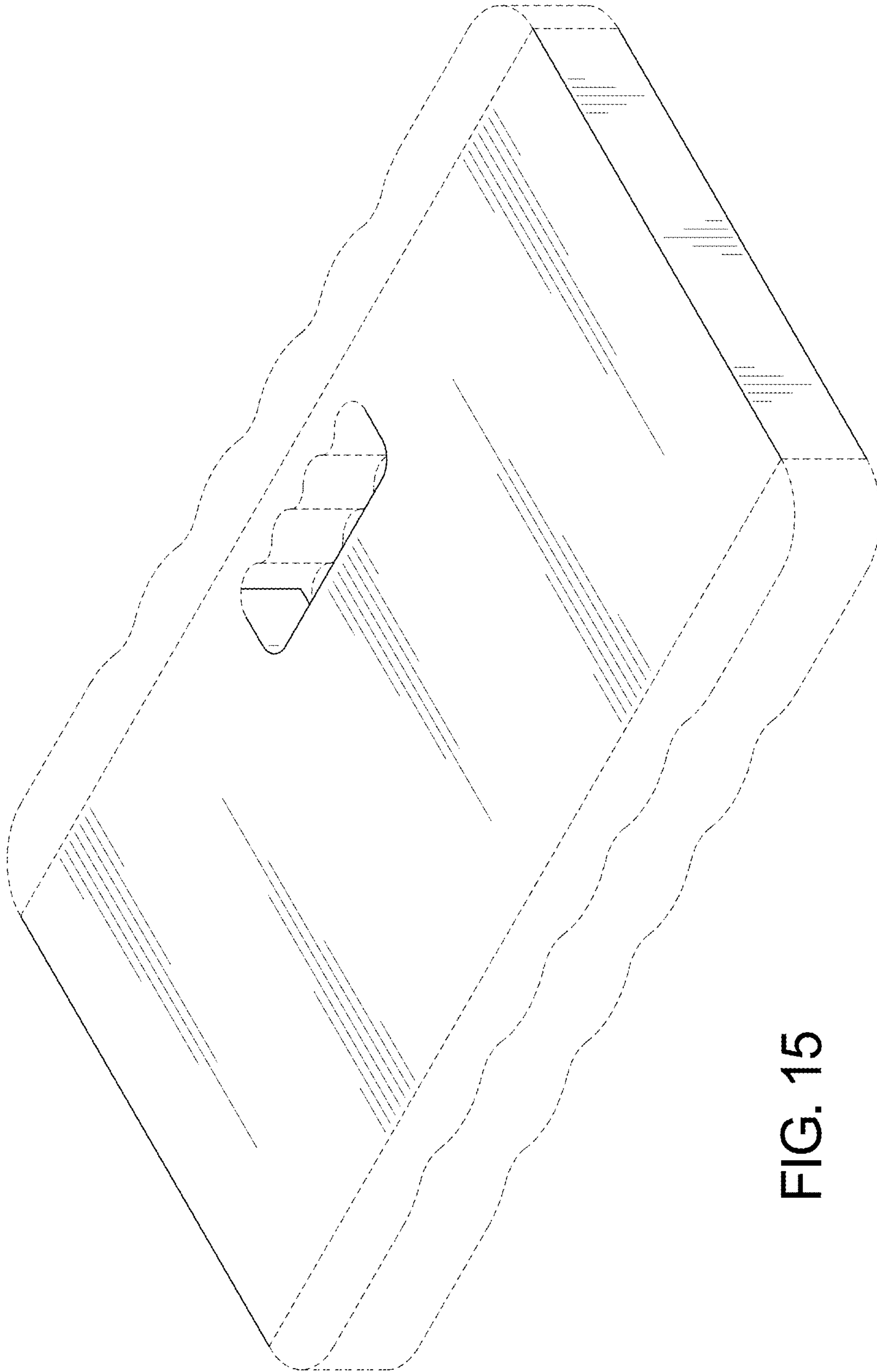

FIG. 15

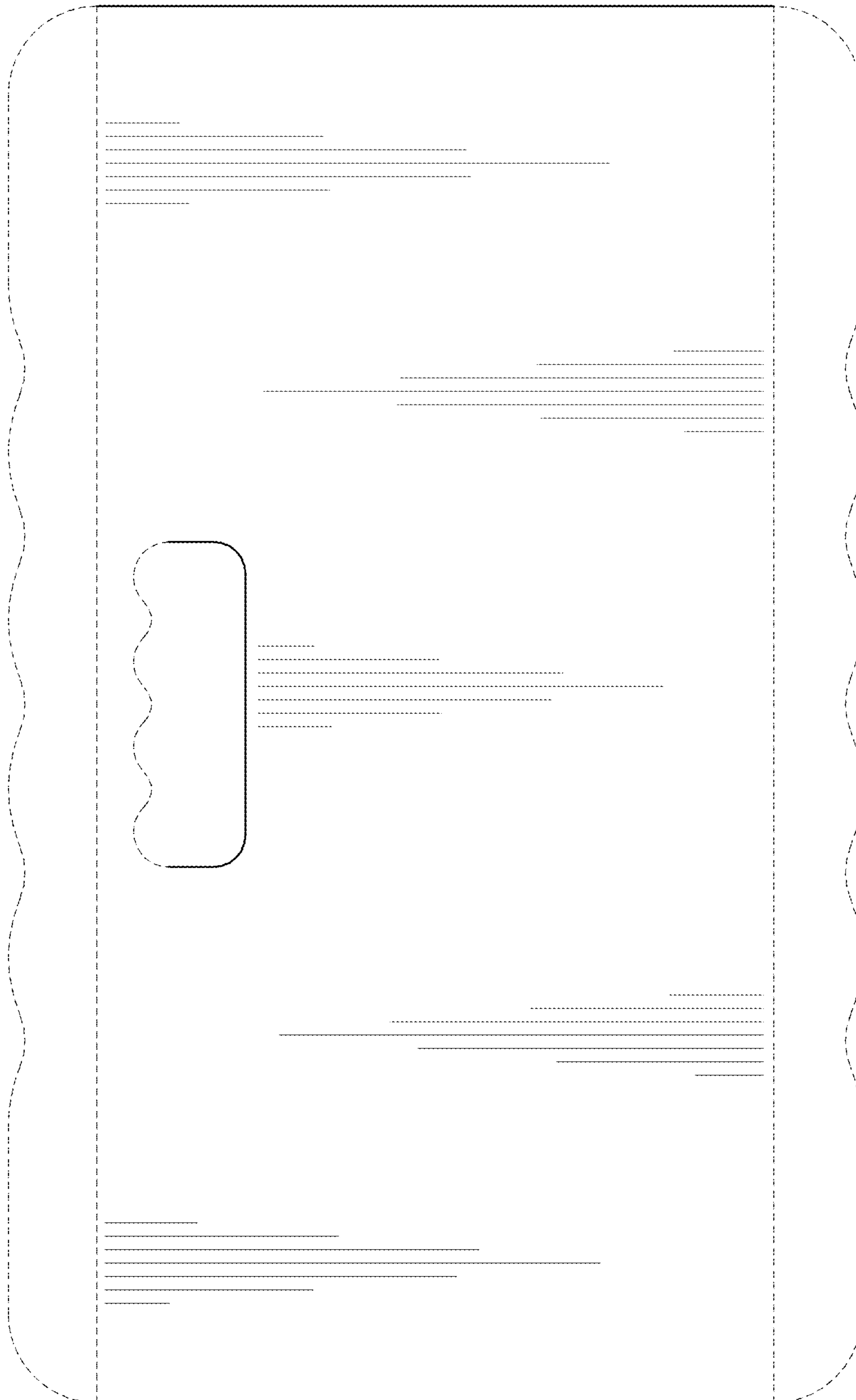

FIG. 16

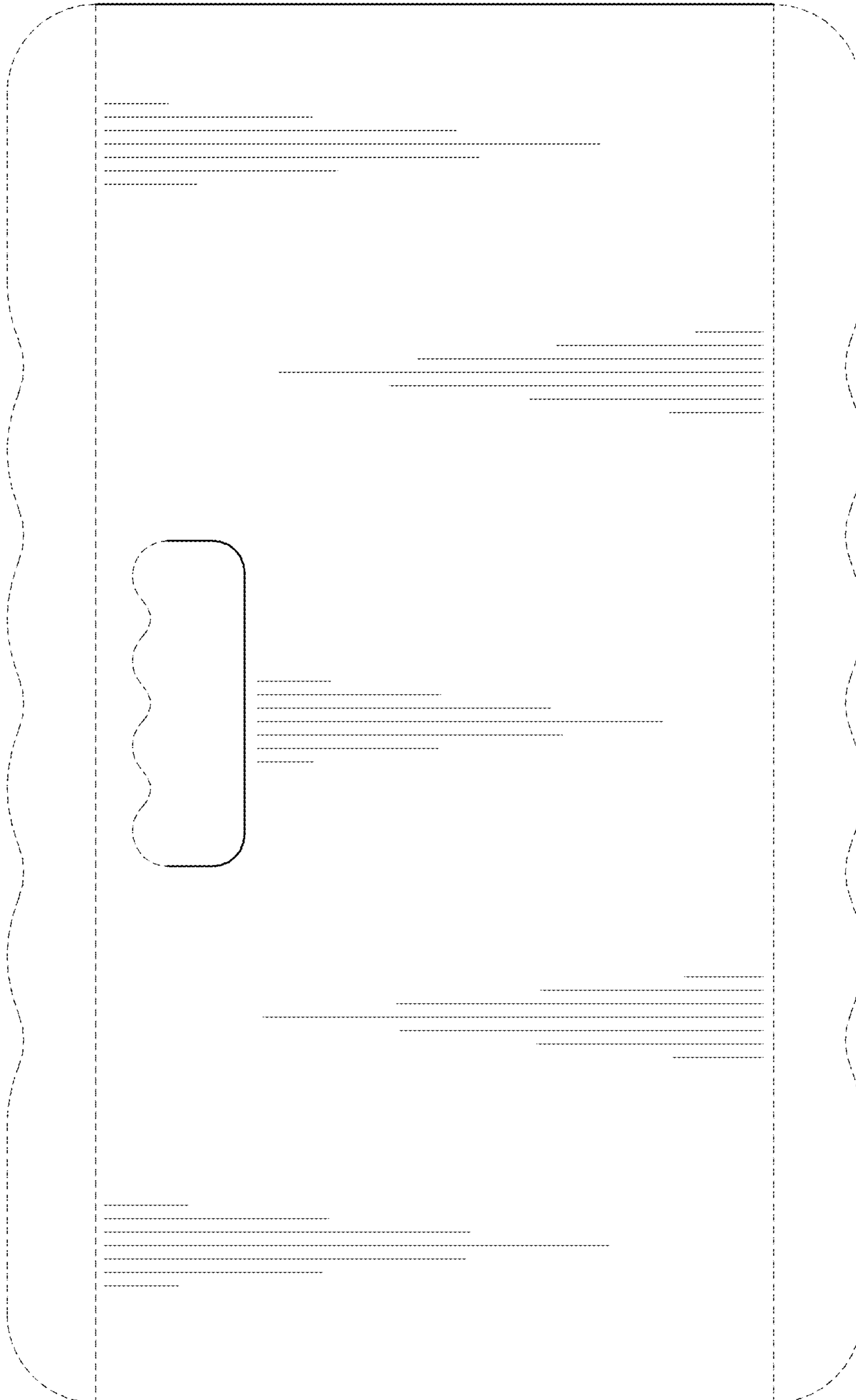

FIG. 17



FIG. 18

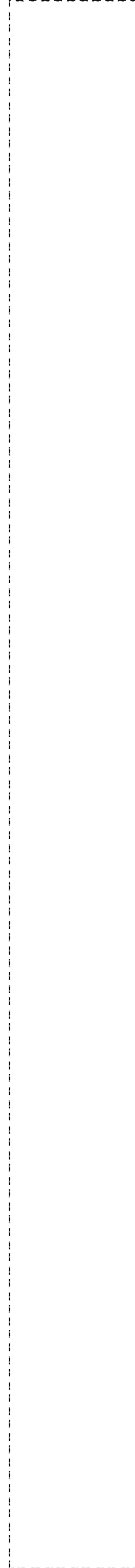

FIG. 19

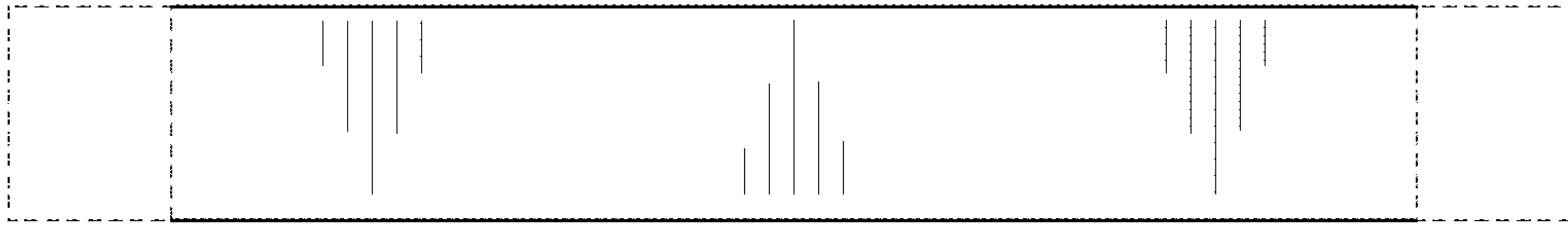

FIG. 21

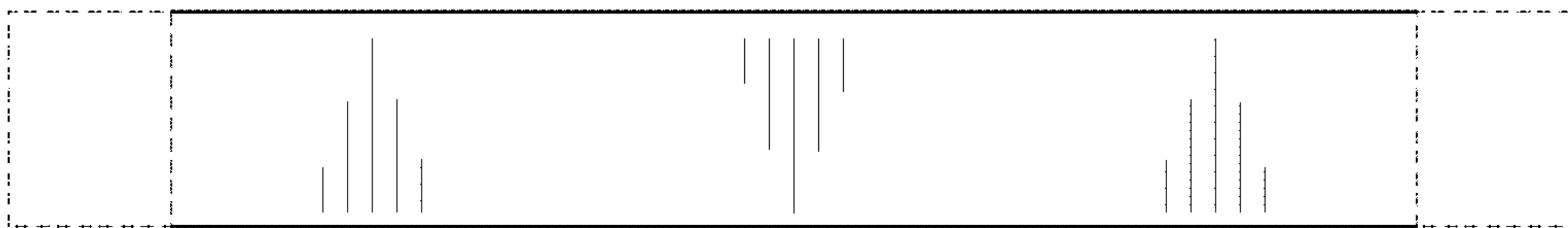

FIG. 20

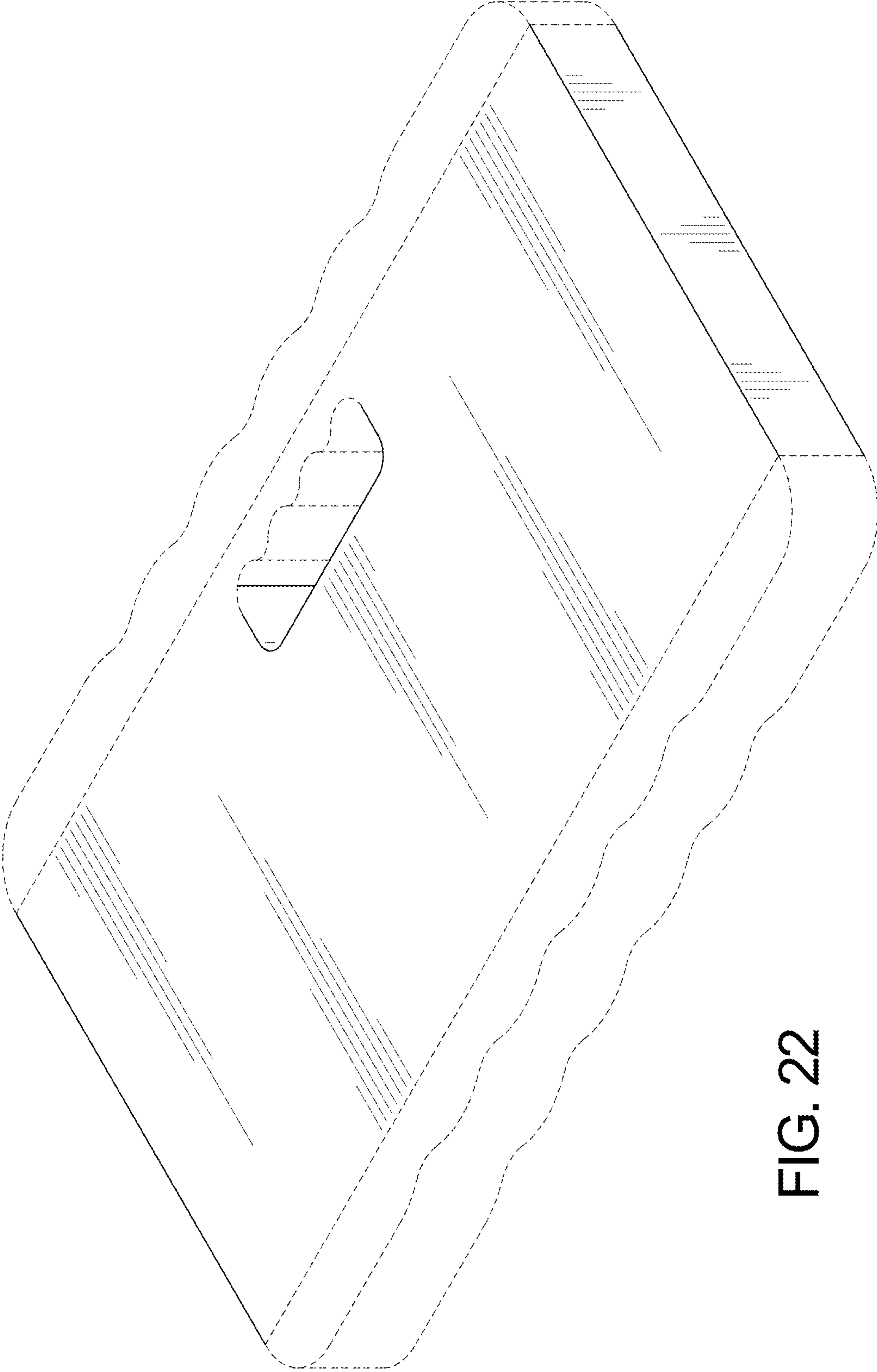

FIG. 22

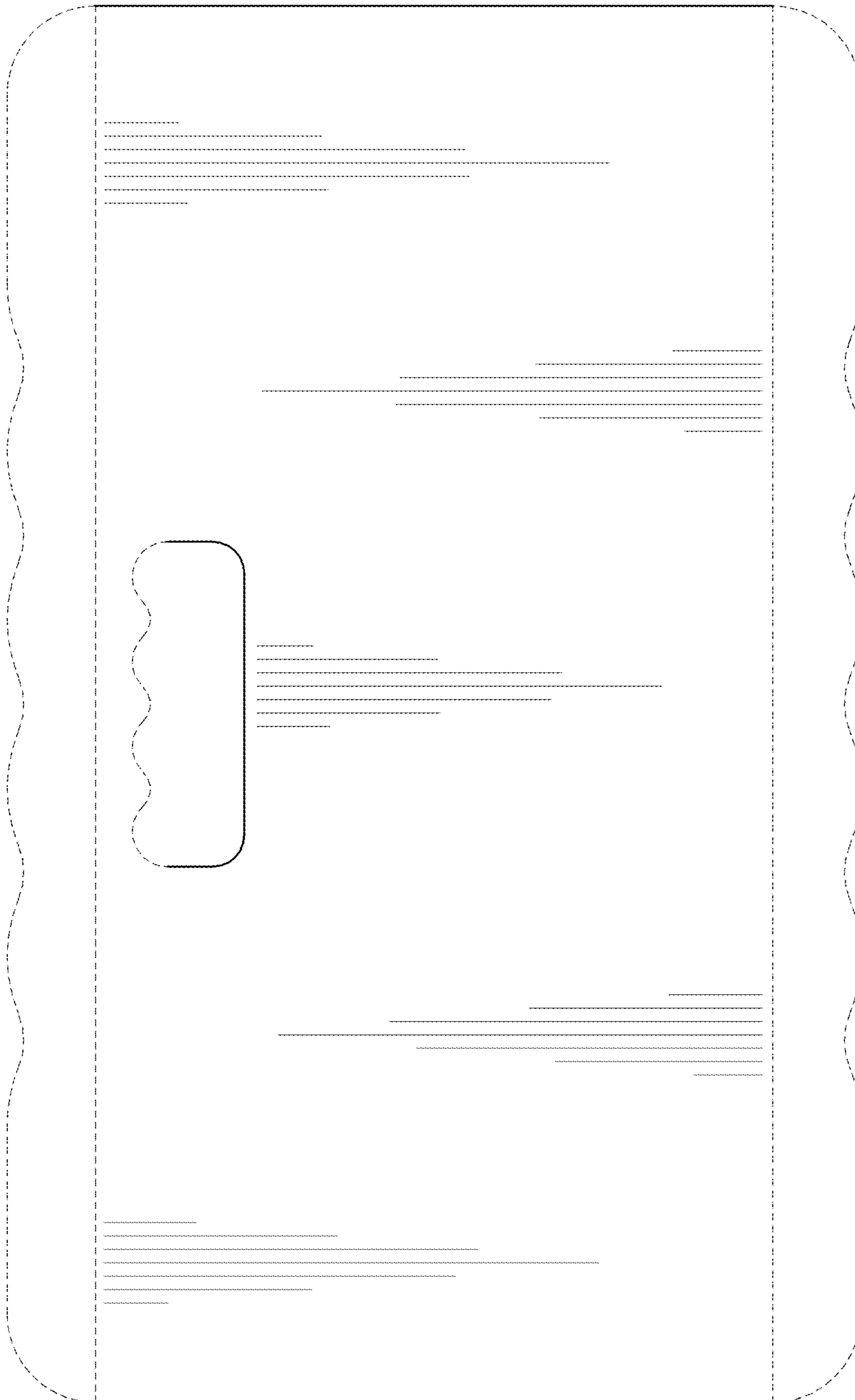

FIG. 23

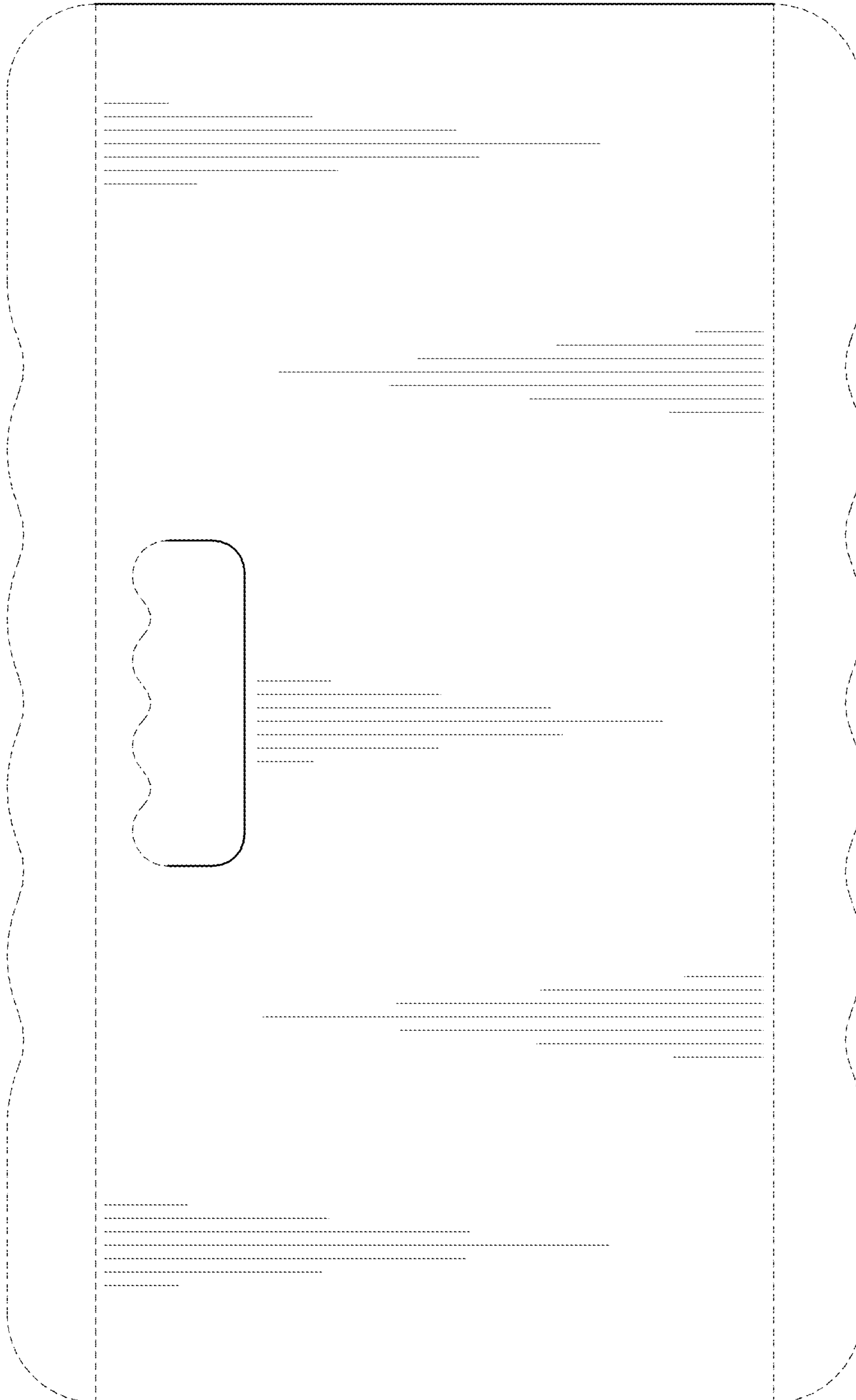

FIG. 24



FIG. 25



FIG. 26

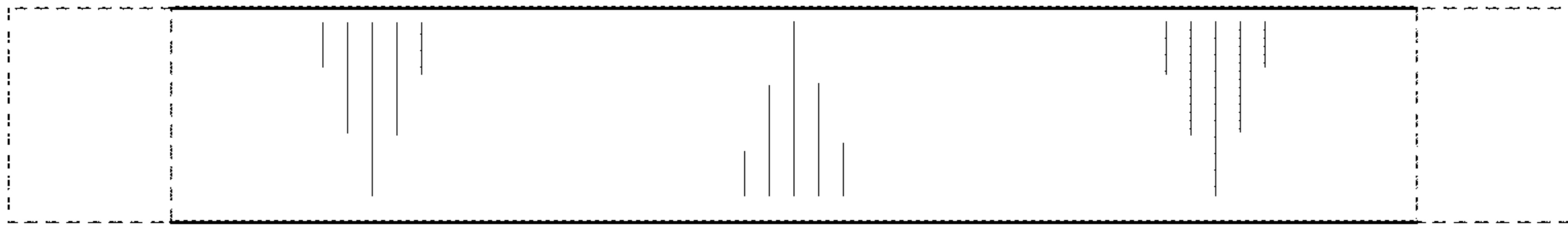

FIG. 28

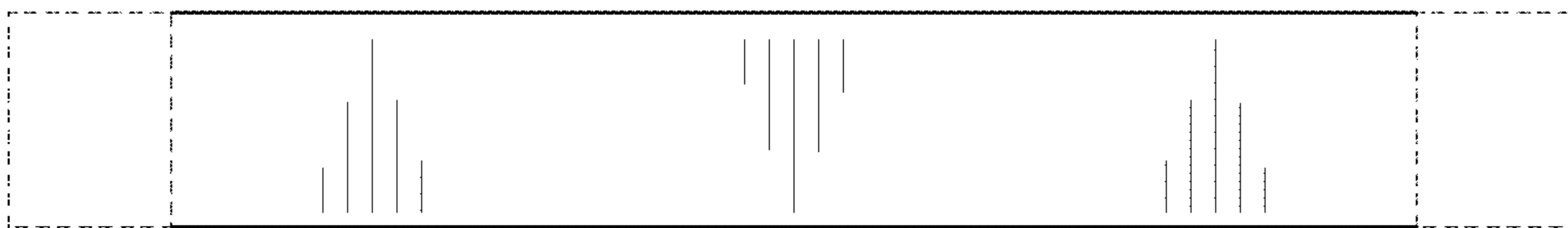

FIG. 27