



US00D951676S

(12) **United States Design Patent**  
**Zheng**

(10) **Patent No.:** **US D951,676 S**

(45) **Date of Patent:** **\*\* May 17, 2022**

- (54) **PILLOW AND EYE MASK KIT**
- (71) Applicant: **SHENZHEN PICTET FINO TECHNOLOGY CO., LTD**, Shenzhen (CN)
- (72) Inventor: **Junsheng Zheng**, Shenzhen (CN)
- (73) Assignee: **SHENZHEN PICTET FINO TECHNOLOGY CO., LTD**, Shenzhen (CN)

- 9,186,276 B2 \* 11/2015 Parziale ..... A61F 9/04
- D745,937 S \* 12/2015 van der Lande ..... D21/604
- D746,080 S \* 12/2015 Mittelstadt ..... D6/601
- D754,246 S \* 4/2016 Tang ..... D17/13
- D761,595 S \* 7/2016 Pulver ..... D6/601
- D769,648 S \* 10/2016 Atkinson ..... D6/601

(Continued)

**FOREIGN PATENT DOCUMENTS**

- CN 303117427 \* 3/2015
- CN 303487454 \* 8/2015

(Continued)

(\*\*) Term: **15 Years**

**OTHER PUBLICATIONS**

- (21) Appl. No.: **29/780,186**
- (22) Filed: **Apr. 22, 2021**
- (51) **LOC (13) Cl.** ..... **06-09**
- (52) **U.S. Cl.**  
USPC ..... **D6/601; D16/309**
- (58) **Field of Classification Search**  
USPC ..... D6/595, 596, 601, 604, 605, 606, 607, D6/608, 609; 5/413 AM, 690, 706, 961, 5/716, 717, 718, 721, 495, 496, 497, 498, 5/499, 490, 491; D16/309  
CPC ..... A47C 19/00; A47C 23/00; A47C 21/026; A47C 27/00; A47C 27/06; A47C 27/08; A47C 27/081; A47C 27/082; A47G 9/10; A47G 9/1009; A47G 9/1027; A47G 9/1045; A47G 9/1063; A47G 9/1072; A47G 9/1081  
See application file for complete search history.

AliExpress: Travel Neck Pillows Eye Mask, earliest date available unknown, [online], [site visited Mar. 10, 2022], Available from Internet, <URL:https://www.aliexpress.com/item/33042110257.html> (Year: 2022).\*

(Continued)

*Primary Examiner* — Sanjeev Paul

(57) **CLAIM**

The ornamental design for a pillow and eye mask kit, as shown and described.

**DESCRIPTION**

FIG. 1 is a perspective view of a pillow and eye mask kit showing my new design;  
FIG. 2 is another perspective view thereof;  
FIG. 3 is a front elevational view thereof;  
FIG. 4 is a rear elevational view thereof;  
FIG. 5 is a left side elevational view thereof;  
FIG. 6 is a right side elevational view thereof;  
FIG. 7 is a top plan view thereof;  
FIG. 8 is a bottom plan view thereof; and,  
FIG. 9 is an exploded perspective view of the pillow and eye mask kit.

**1 Claim, 9 Drawing Sheets**

(56) **References Cited**

**U.S. PATENT DOCUMENTS**

- D322,380 S \* 12/1991 El-Asir ..... D6/601
- D685,161 S \* 7/2013 Sun ..... A47C 7/383
- ..... D2/866
- D736,394 S \* 8/2015 Owoc ..... D2/894
- 9,138,086 B1 \* 9/2015 Bamberg ..... A47G 9/0253
- 9,155,409 B2 \* 10/2015 Cohen ..... A47G 9/10

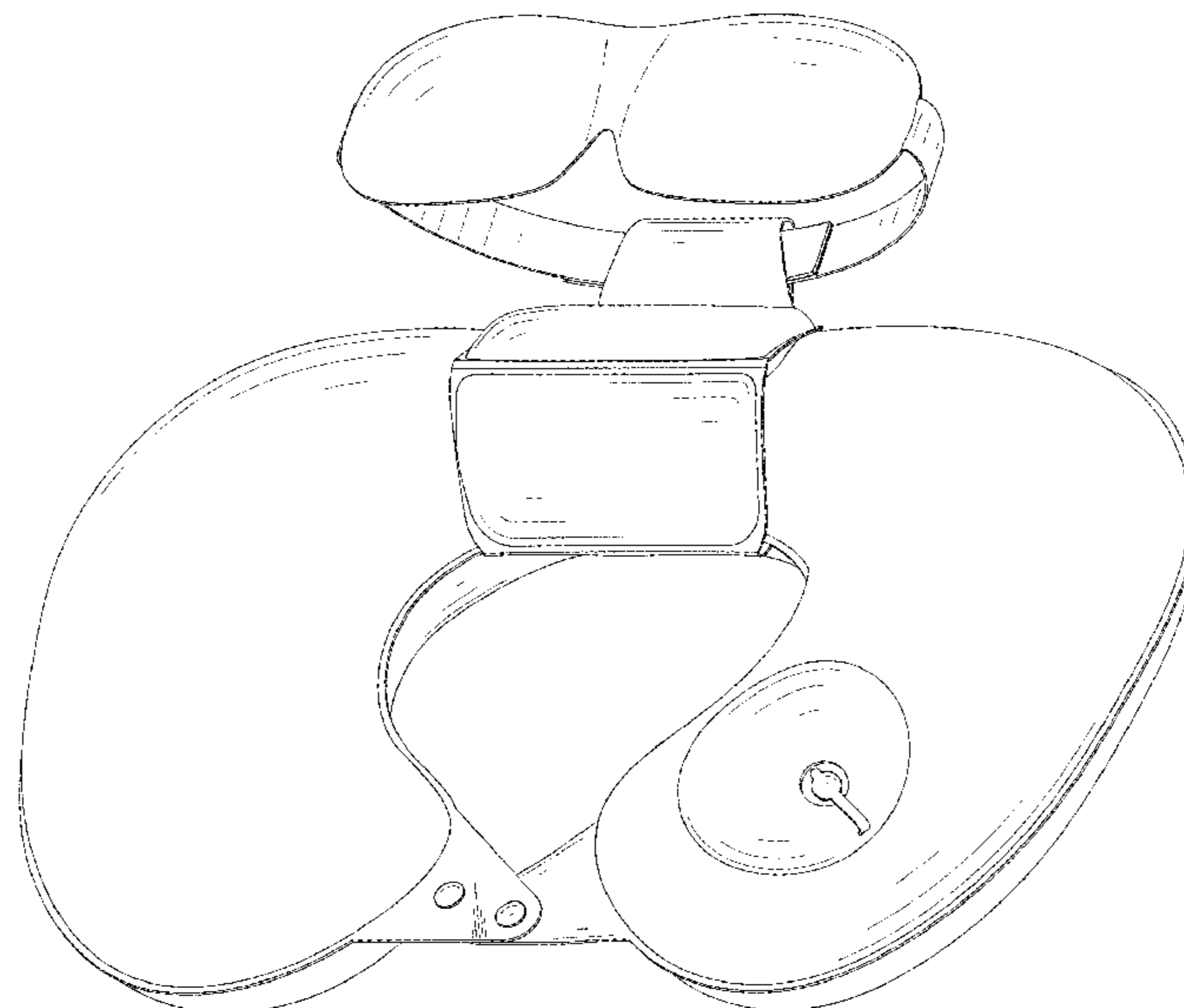

# US D951,676 S

(56)

## References Cited

### U.S. PATENT DOCUMENTS

D781,028	S *	3/2017	Hindley	.....	D2/866
D787,080	S *	5/2017	Baltazar	.....	A61F 7/02 D24/206
D796,869	S *	9/2017	Higashi	.....	D6/601
D811,775	S *	3/2018	Yaish	.....	D6/601
D817,031	S *	5/2018	Denat	.....	D6/601
D823,026	S *	7/2018	Shi	.....	A47C 7/383 D6/601
D838,123	S *	1/2019	Ye	.....	D6/601
D846,913	S *	4/2019	Liu	.....	D6/601
D850,155	S *	6/2019	Liu	.....	D6/601
10,335,318	B2 *	7/2019	Bamberg	.....	A61F 9/04
D856,029	S *	8/2019	Virissimo	.....	D6/601
D873,052	S *	1/2020	Blanc	.....	D6/601
D875,438	S *	2/2020	Liu	.....	D6/601
D878,808	S *	3/2020	Denat	.....	D6/601
D881,605	S *	4/2020	Chen	.....	D6/601
D896,001	S *	9/2020	Estorco		
D898,819	S *	10/2020	Mitsubishi et al.		
D899,138	S	10/2020	Alletto, Jr.		
D899,812	S *	10/2020	Sternlight	.....	D6/601
D899,818	S *	10/2020	Qu	.....	D6/601
D899,819	S *	10/2020	Sutton	.....	D6/601
D900,505	S *	11/2020	Little	.....	D6/601
D905,474	S *	12/2020	Tavis	.....	D6/603
10,863,826	B1 *	12/2020	Schneider	.....	A47G 9/1081
D909,714	S *	2/2021	Hwong	.....	D2/828
D911,067	S *	2/2021	Little	.....	D6/601
D911,747	S *	3/2021	Sutton	.....	D6/601
D913,011	S *	3/2021	Higashi	.....	D6/601
D920,008	S *	5/2021	Lopez	.....	D6/609
D944,561	S *	3/2022	Richardson	.....	D6/601
2005/0150050	A1	7/2005	Wolf et al.		
2012/0144590	A1 *	6/2012	Sharp	.....	A47C 7/383 5/639

2012/0210516	A1 *	8/2012	Popovic	.....	A47G 9/1081 5/636
2013/0125312	A1 *	5/2013	Harooni	.....	A47C 7/383 5/639
2014/0000036	A1 *	1/2014	Cohen	.....	A47C 27/081 5/639

### FOREIGN PATENT DOCUMENTS

CN	304639470	*	5/2018
CN	304984126	*	1/2019
CN	305564946	*	1/2020
CN	305740051	*	4/2020
CN	305798194	*	5/2020
CN	305798197	*	5/2020
EM	008199244-0001	*	11/2020
GB	9008199244-0001	*	10/2020
KR	300933193.0000	*	11/2017
KR	301020245.0000	*	8/2019
KR	301029095.0000	*	10/2019
KR	301051522.0000	*	3/2020
TW	198152-0001	*	6/2019

### OTHER PUBLICATIONS

AliExpress: Multifunctional 2 in 1 Travel Neck Pillow & Eye Mask, earliest date available unknown, [online], [site visited Mar. 10, 2022], Available from Internet, <URL:https://www.aliexpress.com/item/32962763677.html> (Year: 2022).\*

Google Search: "neck pillow with eye mask" <URL:https://www.google.com/search?q=neck+pillow+with+eye+mask&sxsrfr=APq-WBvaaE6hwp7V1pHwqj\_PJnsrKI2Qzg:1646950442058&source=lnms&tbm=isch&sa=X&ved=2ahUKEwie1L7AyLz2AhU0j3IEHaAAcL8Q\_AUoAnoECAEQBA&biw=1200&bih=1777&dpr=1> (Year: 2022).\*

\* cited by examiner

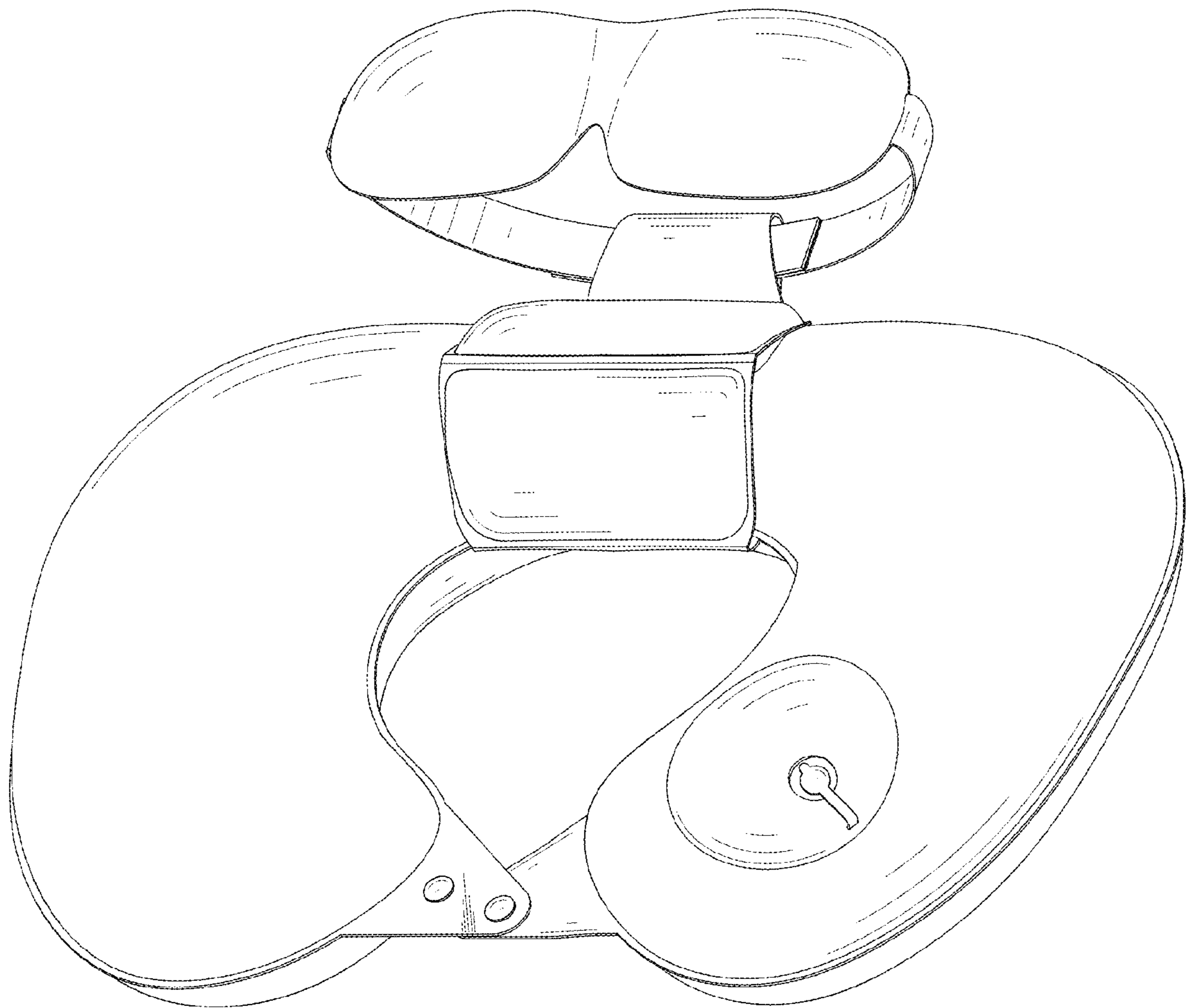

FIG. 1

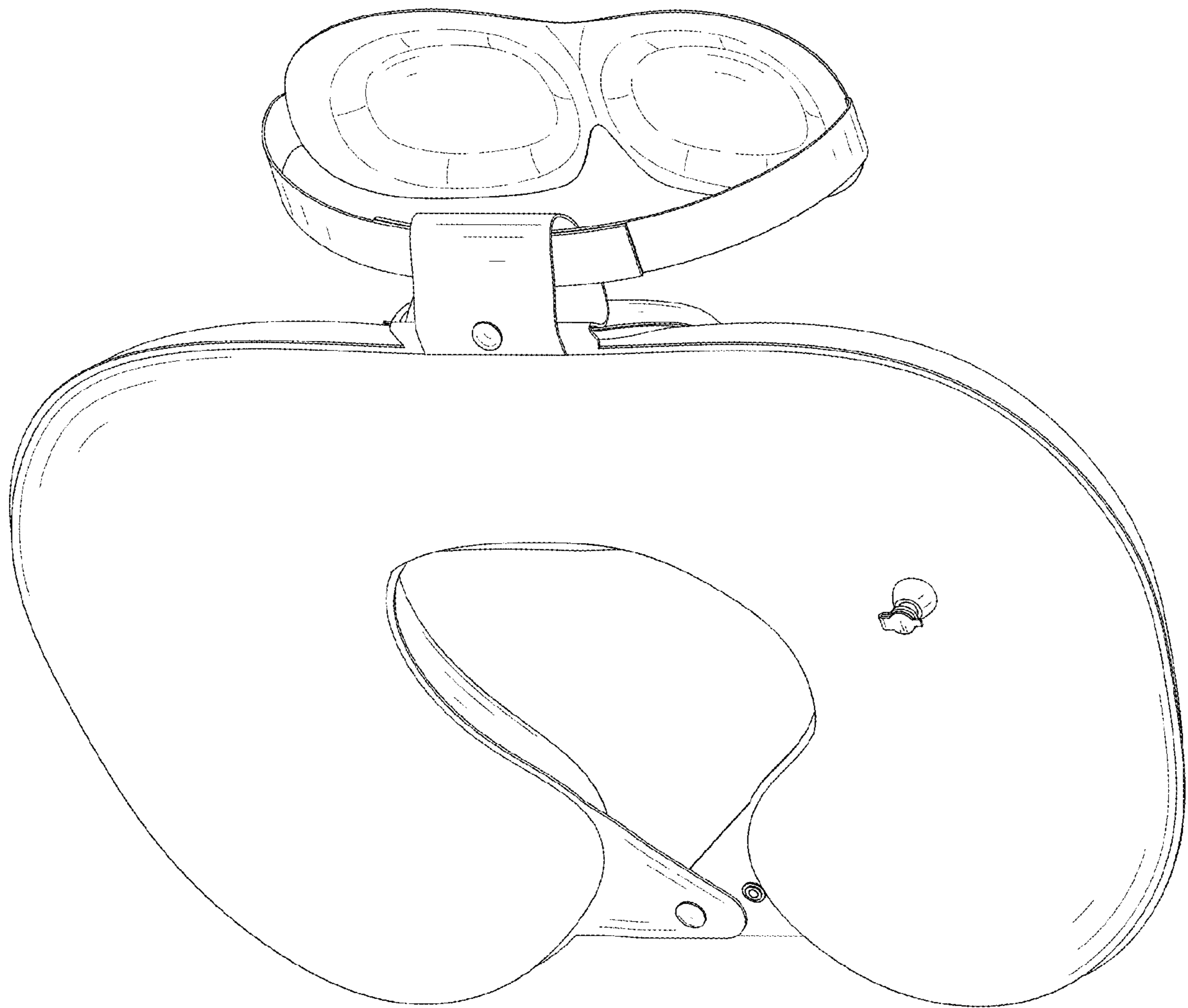

FIG. 2

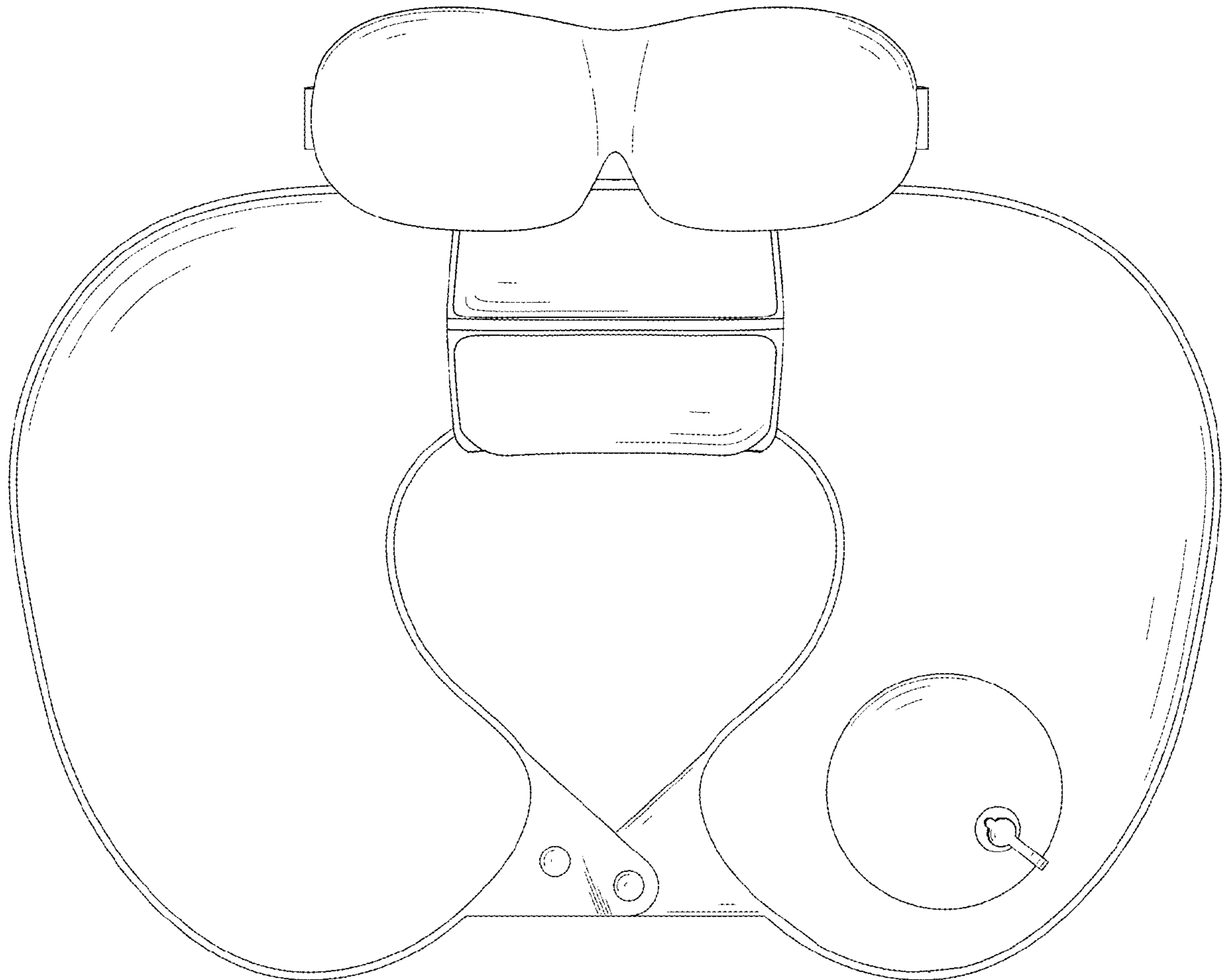

FIG. 3

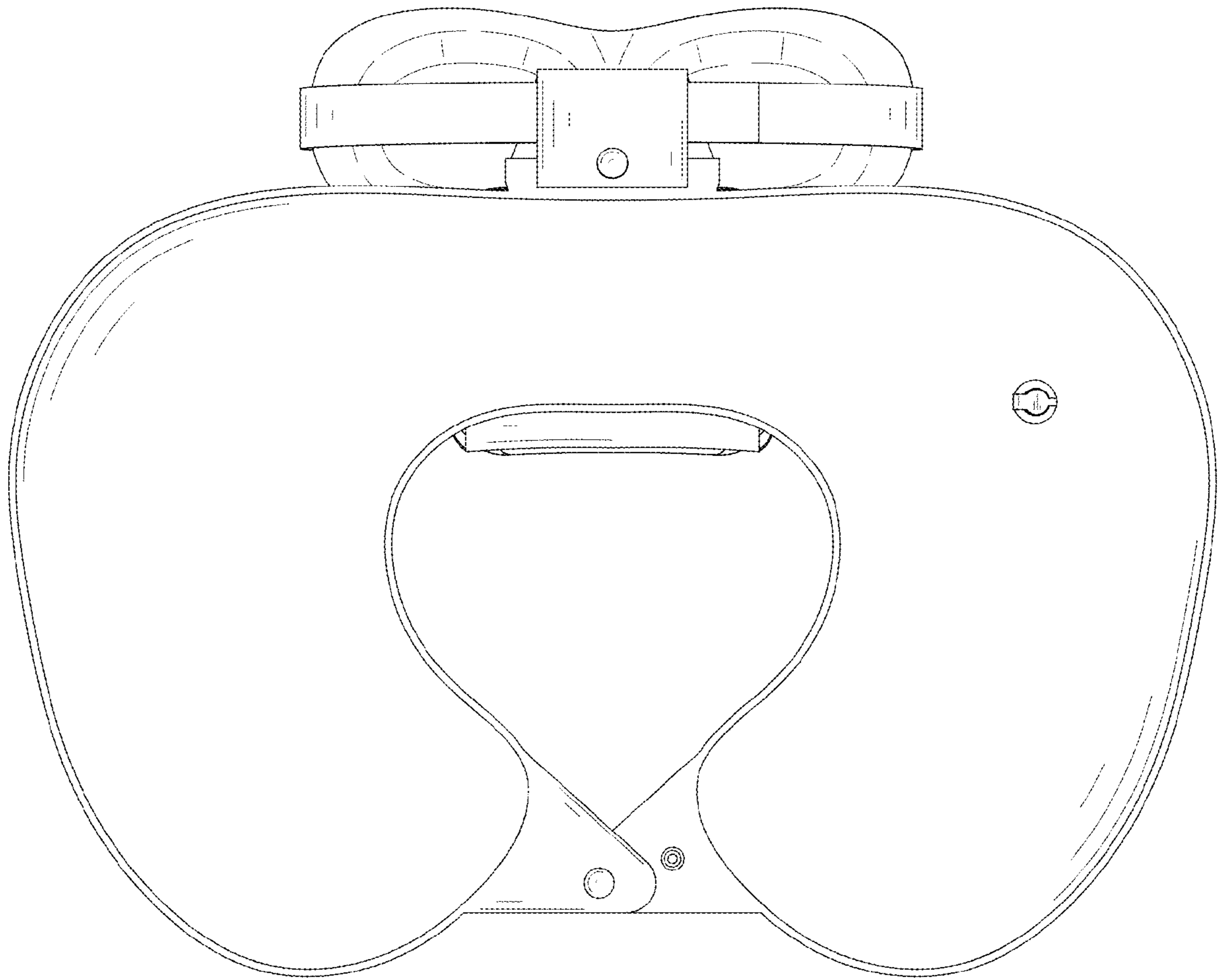

FIG. 4

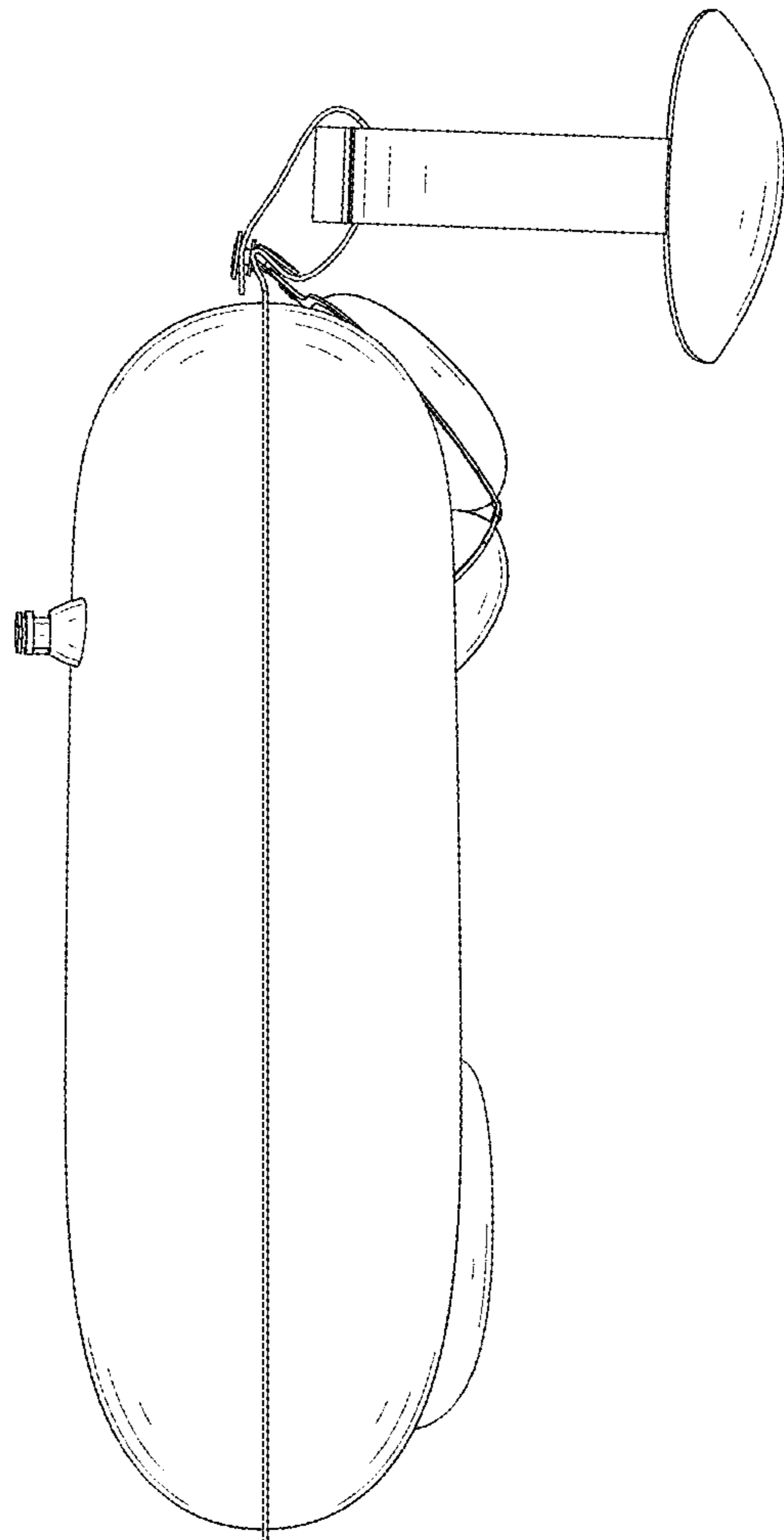

FIG. 5

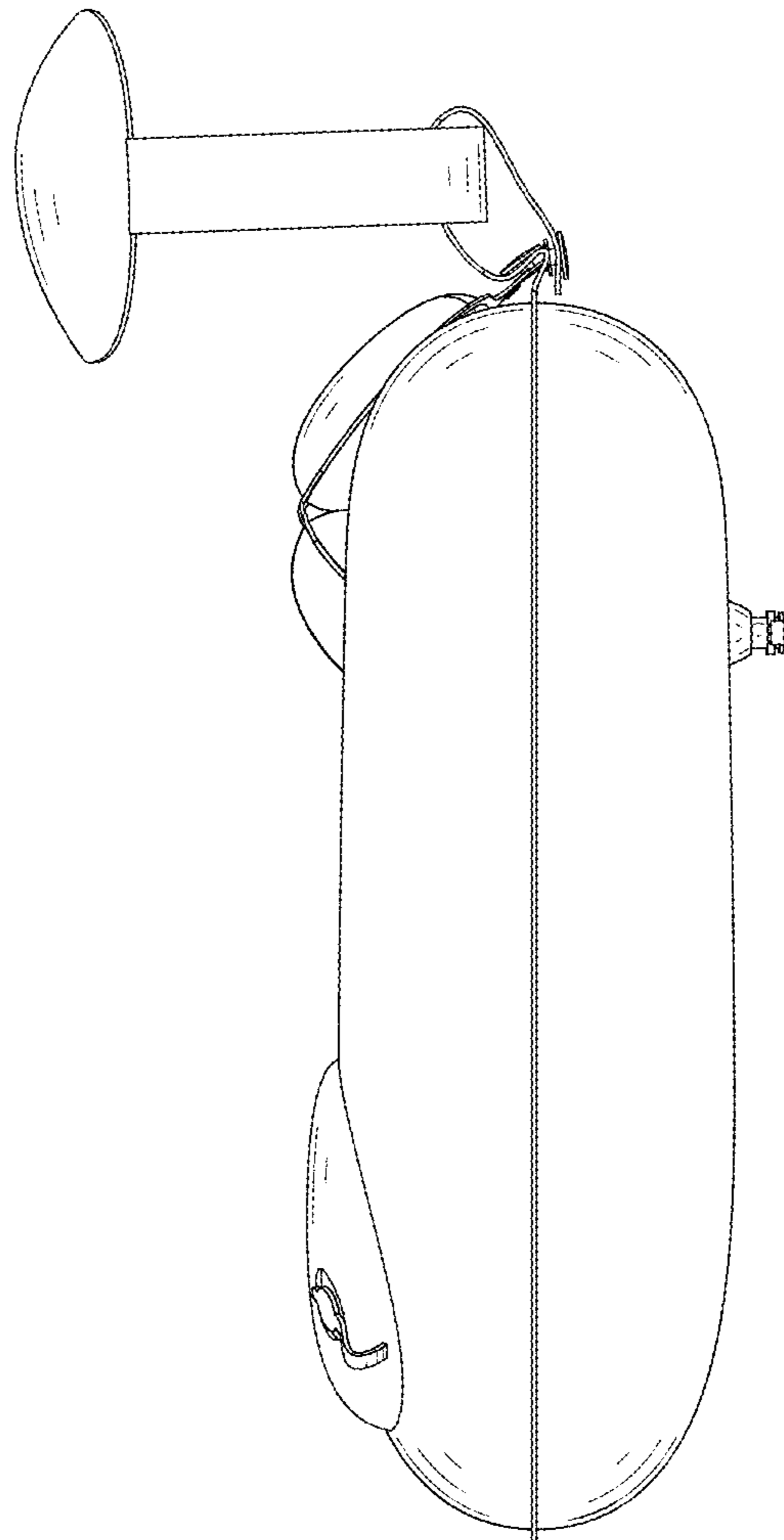

FIG. 6



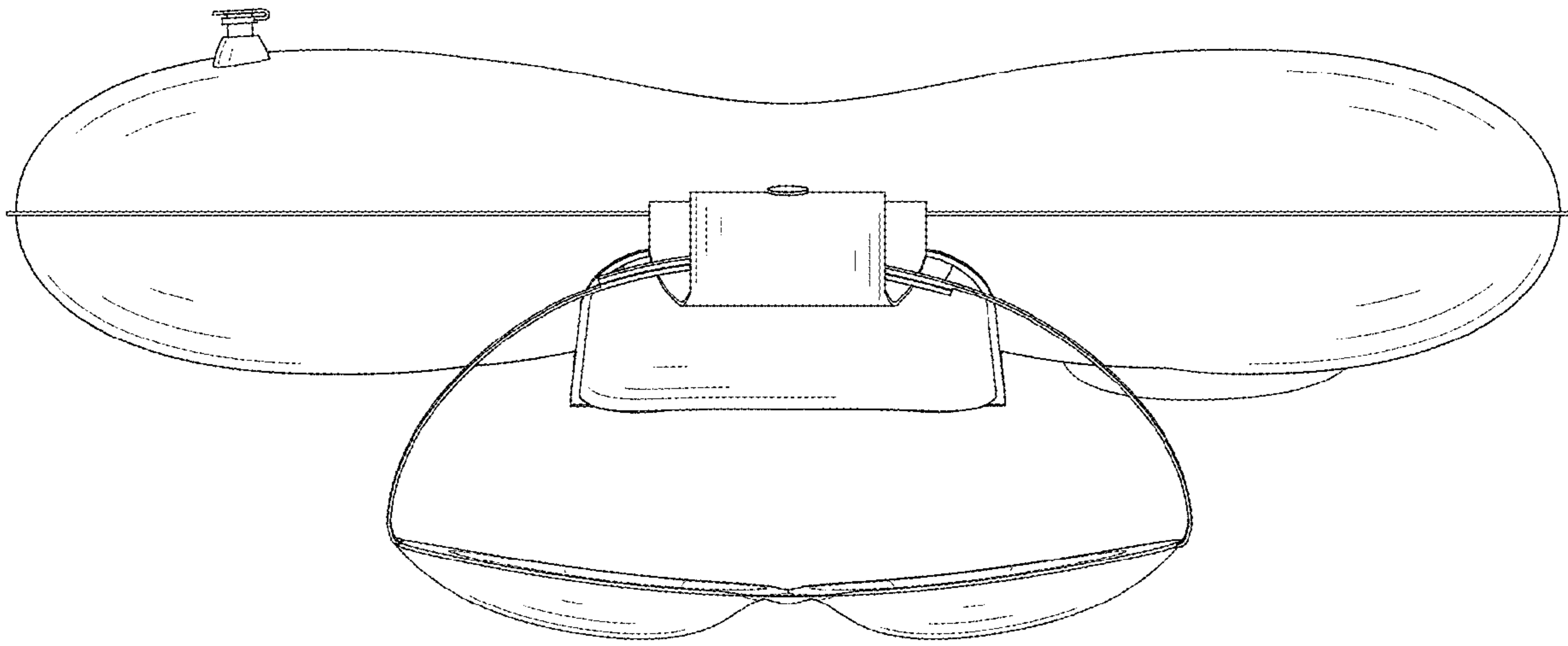

FIG. 7

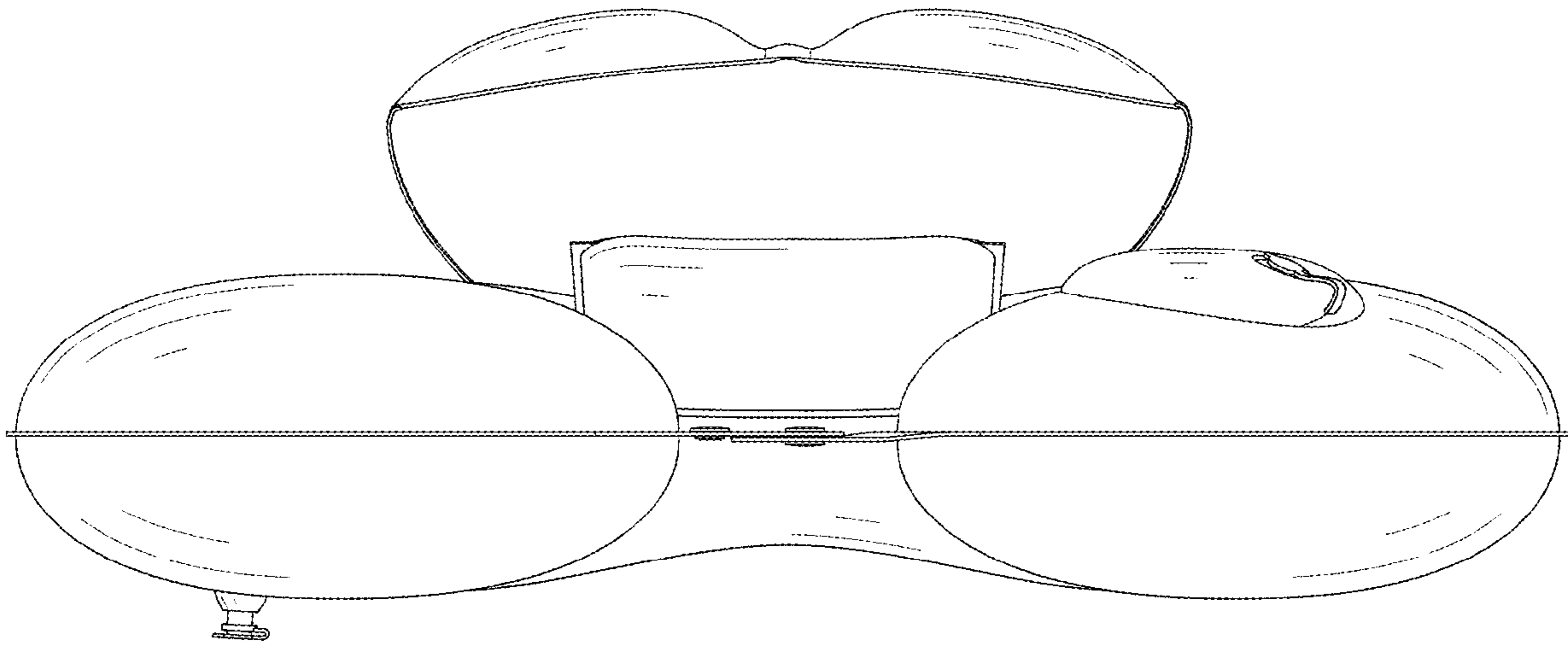

FIG. 8

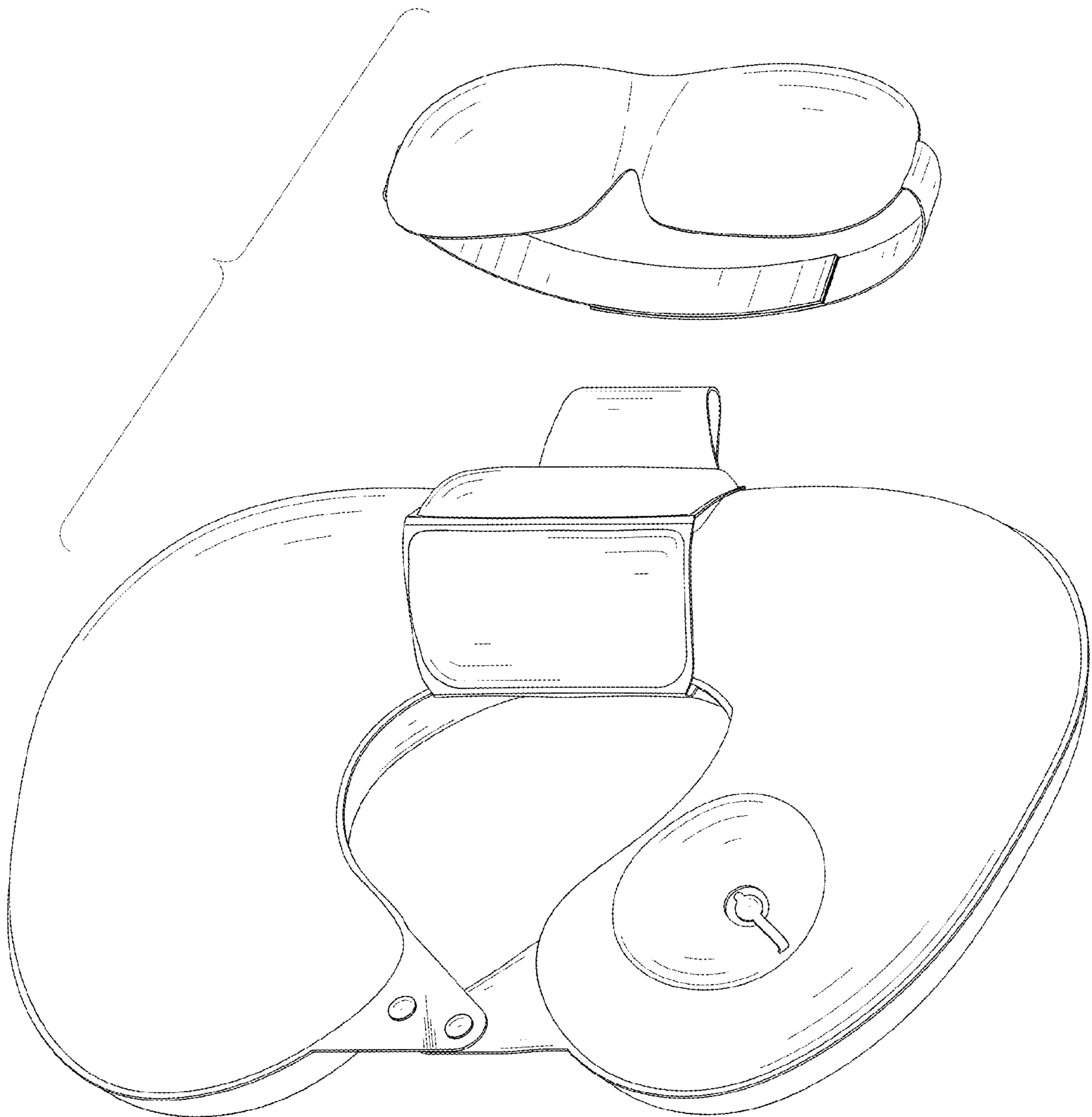

FIG. 9