



US00D951640S

(12) **United States Design Patent**
Kellerer

(10) **Patent No.:** **US D951,640 S**

(45) **Date of Patent:** **** May 17, 2022**

(54) **CONTAINER WITH REMOVABLE BINS**

(71) Applicant: **Schoeller Allibert GmbH**, Schwerin (DE)

(72) Inventor: **Richard Kellerer**, Feldkirchen (DE)

(73) Assignee: **SCHOELLER ALLIBERT GMBH**, Schwerin (DE)

(**) Term: **15 Years**

(21) Appl. No.: **29/713,054**

(22) Filed: **Nov. 13, 2019**

(30) **Foreign Application Priority Data**

May 14, 2019 (DE) 40 2019 100 529.3

(51) **LOC (13) Cl.** **03-01**

(52) **U.S. Cl.**
USPC **D3/305; D3/310**

(58) **Field of Classification Search**
USPC D3/272, 304–315, 318–319, 321,
D3/901–902; D6/672–673, 675, 675.1,
(Continued)

(56) **References Cited**

U.S. PATENT DOCUMENTS

D302,897 S * 8/1989 Shchamorov D32/46
5,469,986 A * 11/1995 Jang B65D 25/32
220/762

(Continued)

OTHER PUBLICATIONS

Small Parts Organizer with Removable Bins, unknown first available date, containerstore.com [online], [site visited Aug. 11, 2021], Available at internet URL: <https://www.containerstore.com/s/Orange/small-parts-organizer-with-removable-bins/cd?productId=11012611> (Year: 2021).*

Primary Examiner — Michelle E. Wilson

Assistant Examiner — Caitlin A Laverty

(74) *Attorney, Agent, or Firm* — Culhane Meadows PLLC; Christopher A. Rothe

(57) **CLAIM**

The ornamental design for a combined container and removable bins, as shown and described.

DESCRIPTION

FIG. 1 is a perspective view of a container according to the present invention;

FIG. 2 is a front view thereof;

FIG. 3 is a rear view thereof;

FIG. 4 is a left side view thereof;

FIG. 5 is a right side view thereof;

FIG. 6 is a top view thereof;

FIG. 7 is a bottom view thereof;

FIG. 8 is a perspective view of the container according to FIG. 1 containing a first set of eight identical removable bins according to the present invention;

FIG. 9 is a front view thereof;

FIG. 10 is a rear view thereof;

FIG. 11 is a left side view thereof;

FIG. 12 is a right side view thereof;

FIG. 13 is a top view thereof;

FIG. 14 is a bottom view thereof;

FIG. 15 is a first perspective view of one of the eight identical removable bins shown within the container in FIG. 8, separated from the container to more clearly show the bin's appearance, showing parts thereof in a closed state;

FIG. 16 is a second perspective view thereof, showing parts thereof in an open state;

FIG. 17 is a front view thereof;

FIG. 18 is a rear view thereof;

FIG. 19 is a left side view thereof;

FIG. 20 is a right side view thereof;

FIG. 21 is a top view thereof; and,

FIG. 22 is a bottom view thereof.

The broken lines depict portions of the container that form no part of the claimed design.

1 Claim, 13 Drawing Sheets

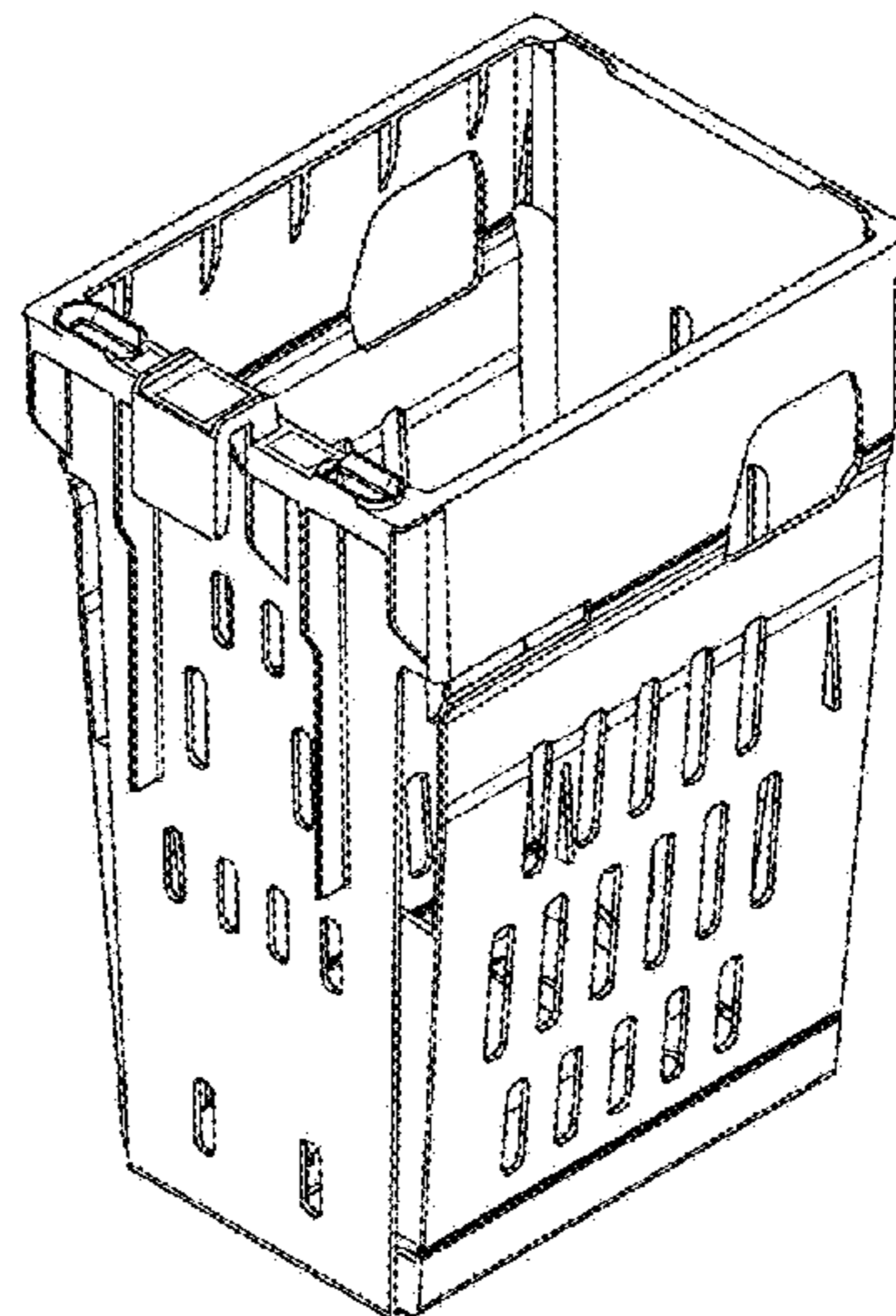
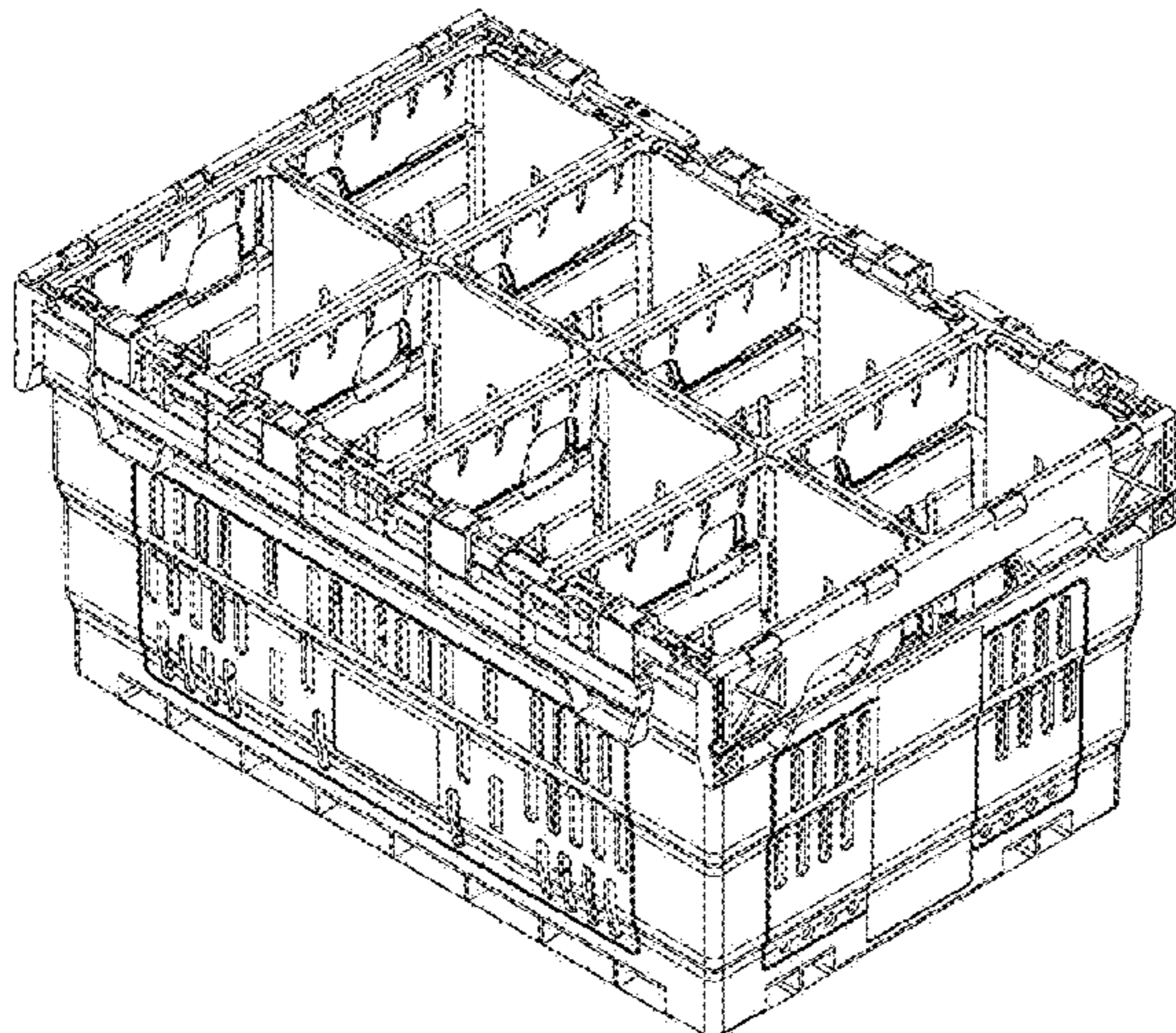

(58) **Field of Classification Search**

USPC D6/683, 683.1, 583; D7/600, 600.1;
D15/89; D34/17, 24
CPC ... B65D 1/00; B65D 1/22; B65D 1/24; B65D
1/34; B65D 1/36; B65D 1/38; B65D
1/225; B65D 1/243; B65D 5/00; B65D
5/42; B65D 7/14; B65D 11/00; B65D
11/14; B65D 11/20; B65D 19/00; B65D
19/02; B65D 21/00; B65D 21/02; B65D
43/162; B65D 71/0003; B65D 81/3813;
B65D 81/02; B65D 2543/00194; B65D
2543/00296; B65D 2543/00222

See application file for complete search history.

(56) **References Cited**

U.S. PATENT DOCUMENTS

D374,555 S * 10/1996 McMath D3/272
D381,513 S * 7/1997 Brauner D3/305
D400,711 S * 11/1998 Hwang D3/307
D423,217 S * 4/2000 Varfeldt D3/201
D663,121 S * 7/2012 Barth D3/304
D802,926 S * 11/2017 Turner D3/304
D810,439 S * 2/2018 Martin Tellez D3/314
D930,985 S * 9/2021 Lu D3/305
D933,364 S * 10/2021 Chen D3/305
2011/0108558 A1* 5/2011 Magni B65D 11/20
220/592.01
2011/0240657 A1* 10/2011 Orgeldinger B65D 1/22
220/601
2018/0016060 A1* 1/2018 Peach B65D 21/0234
2020/0331651 A1* 10/2020 Swartz B65D 1/22

* cited by examiner

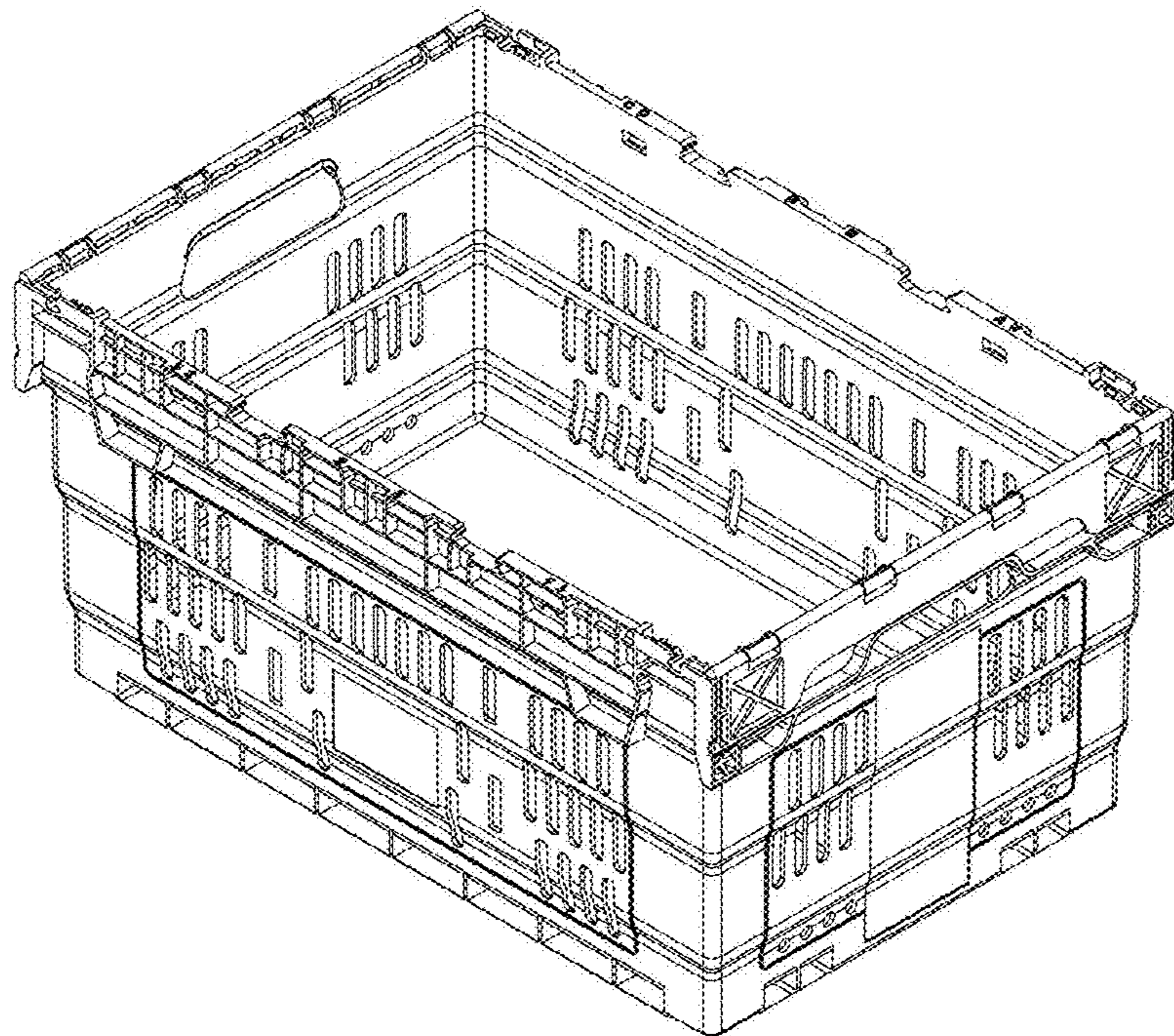

FIG. 1

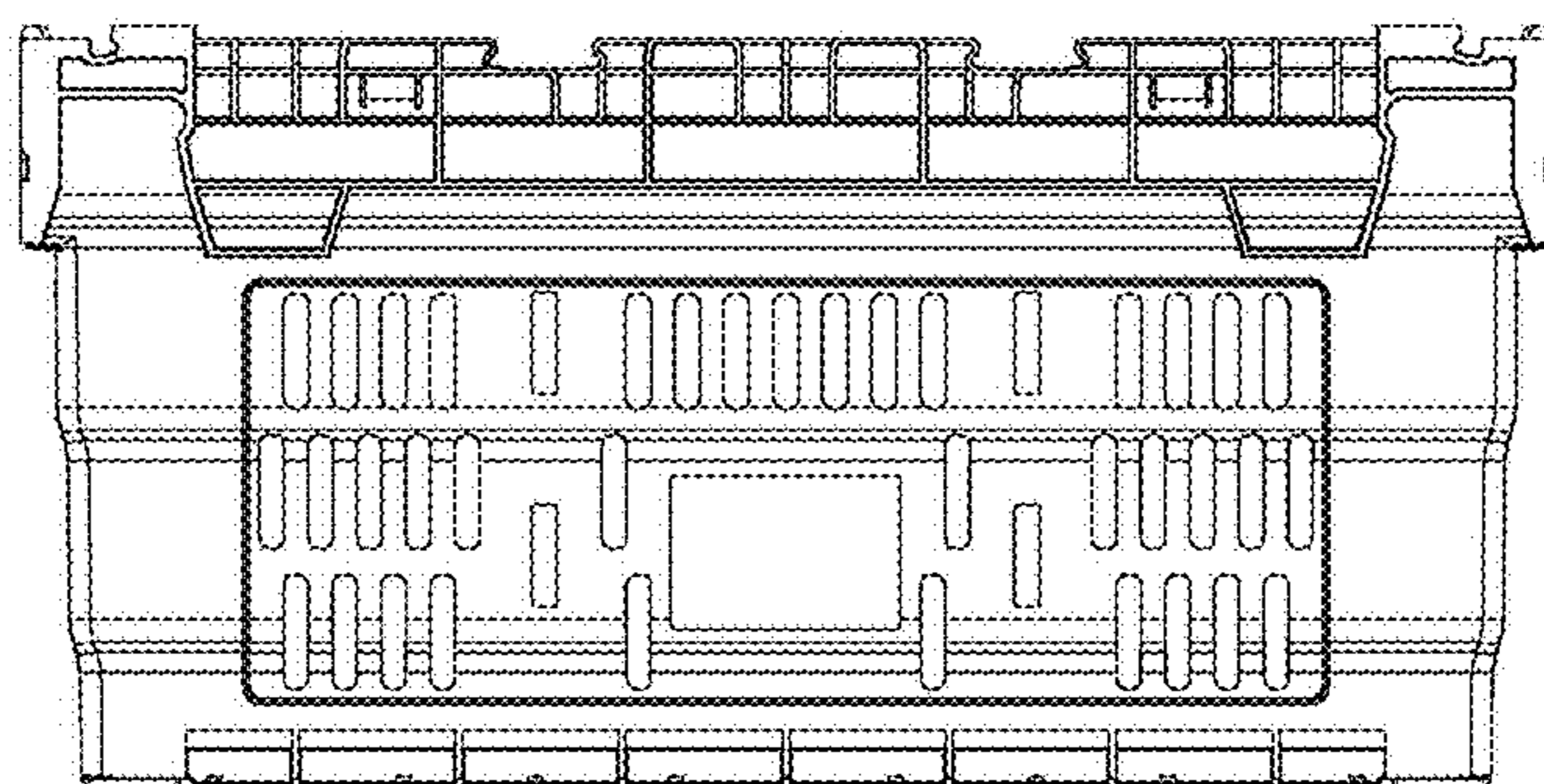

FIG. 2

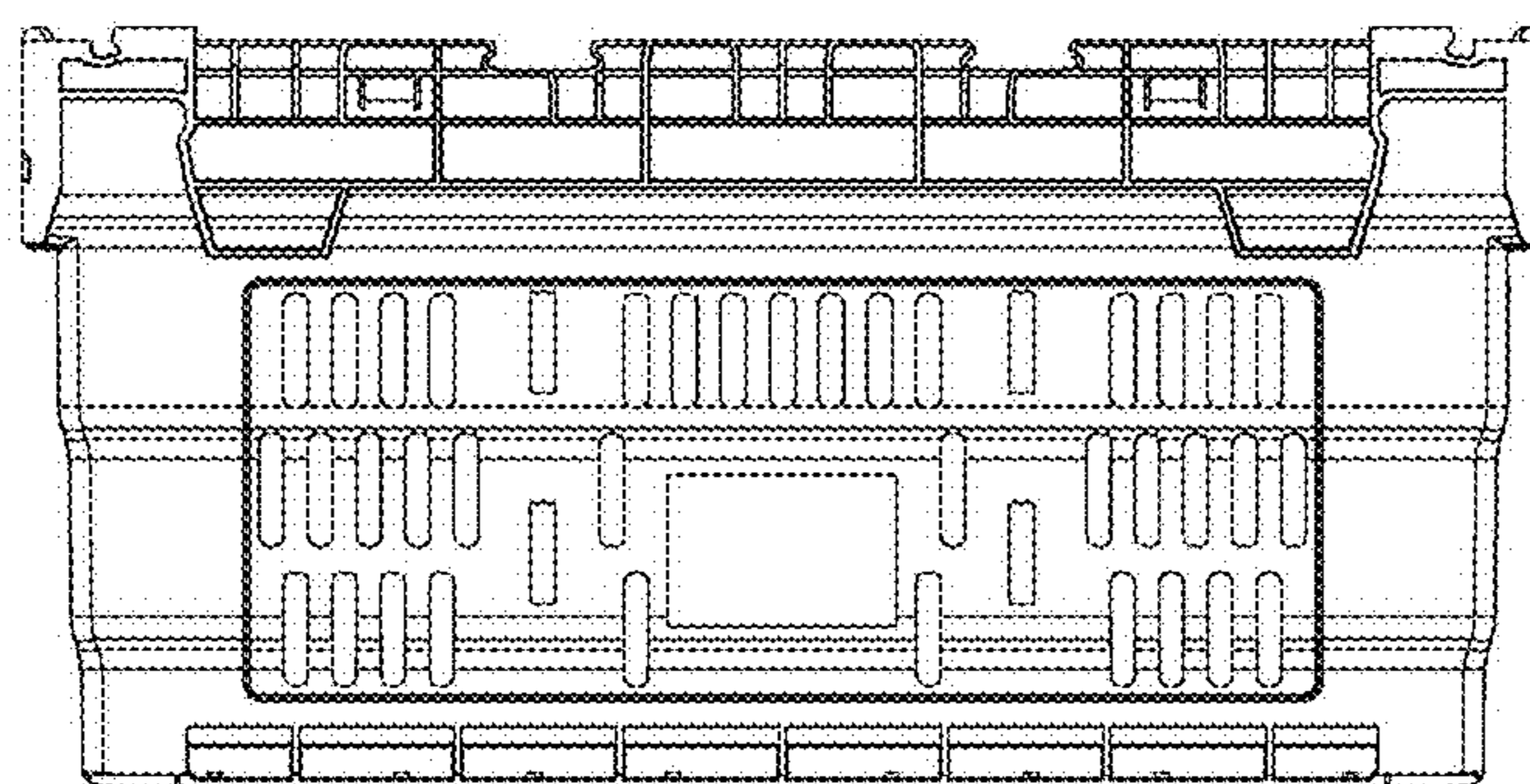

FIG. 3

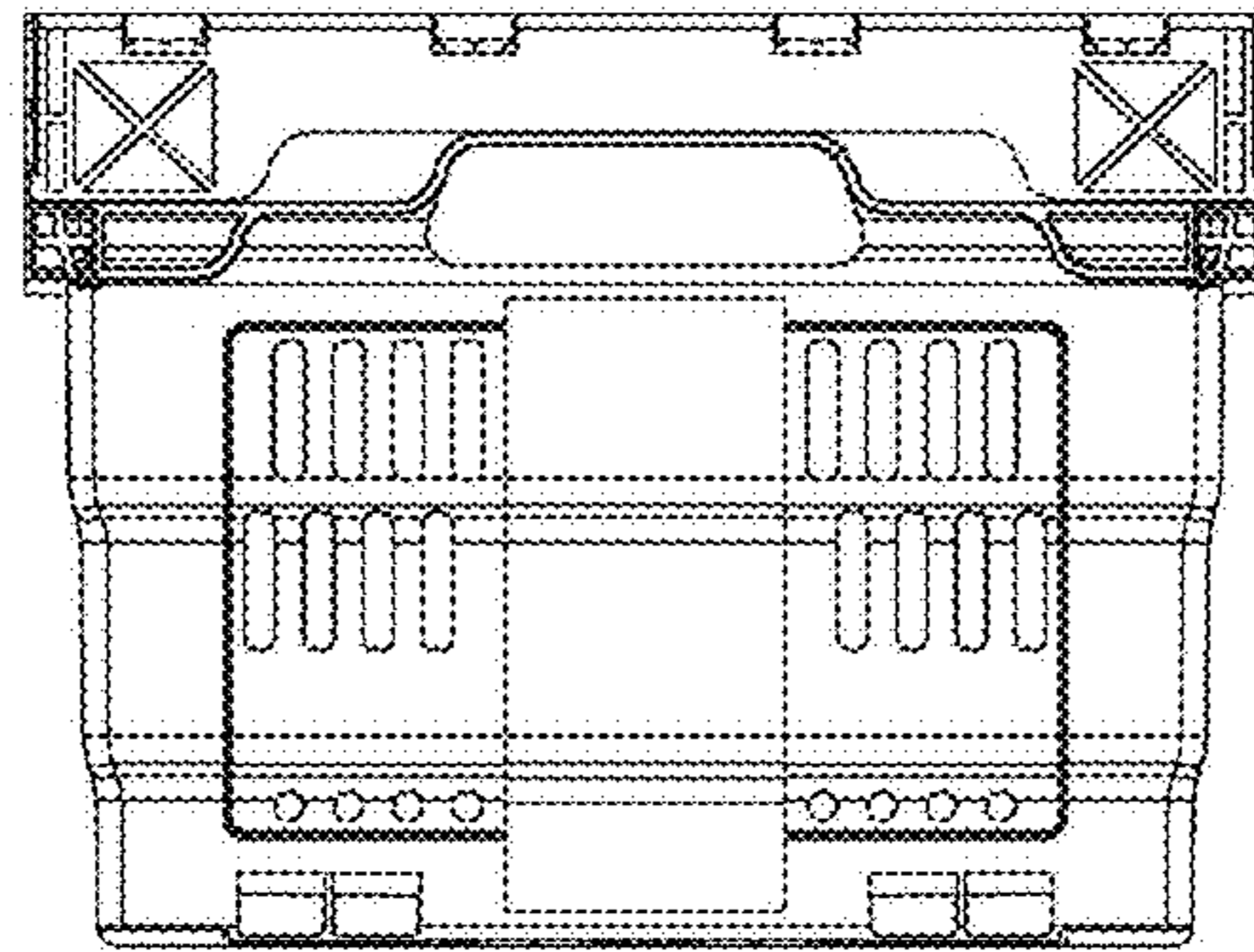

FIG. 4

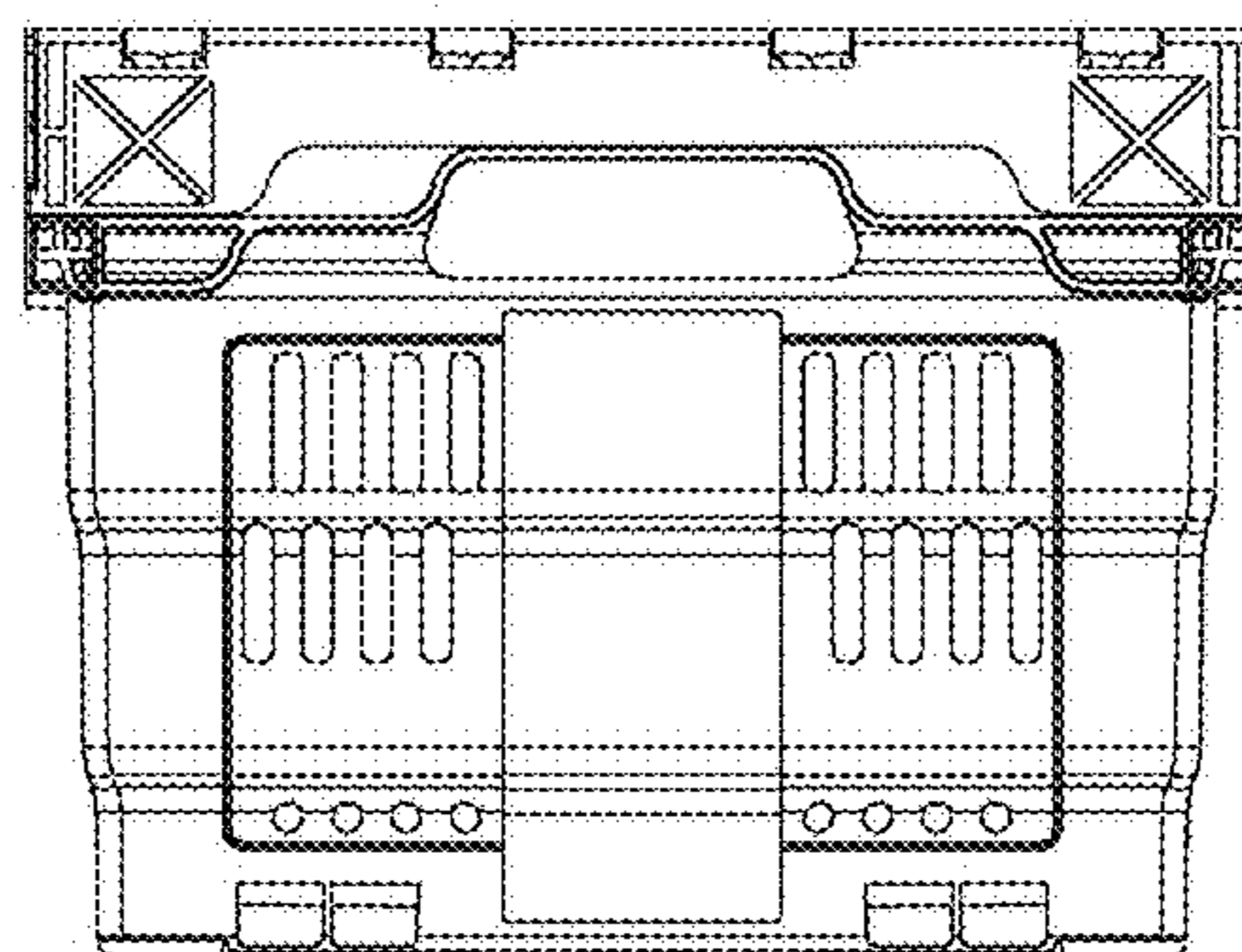

FIG. 5

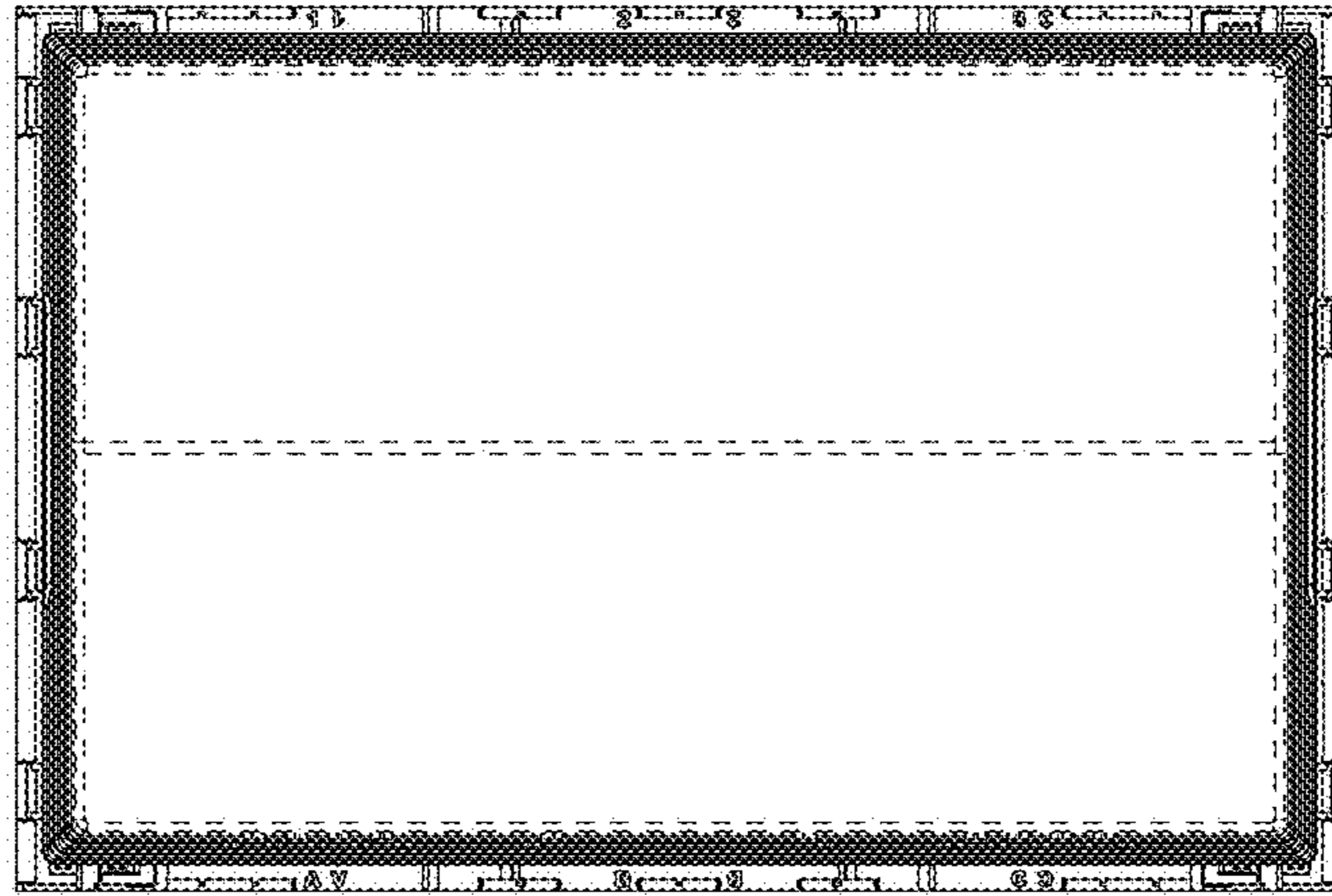

FIG. 6

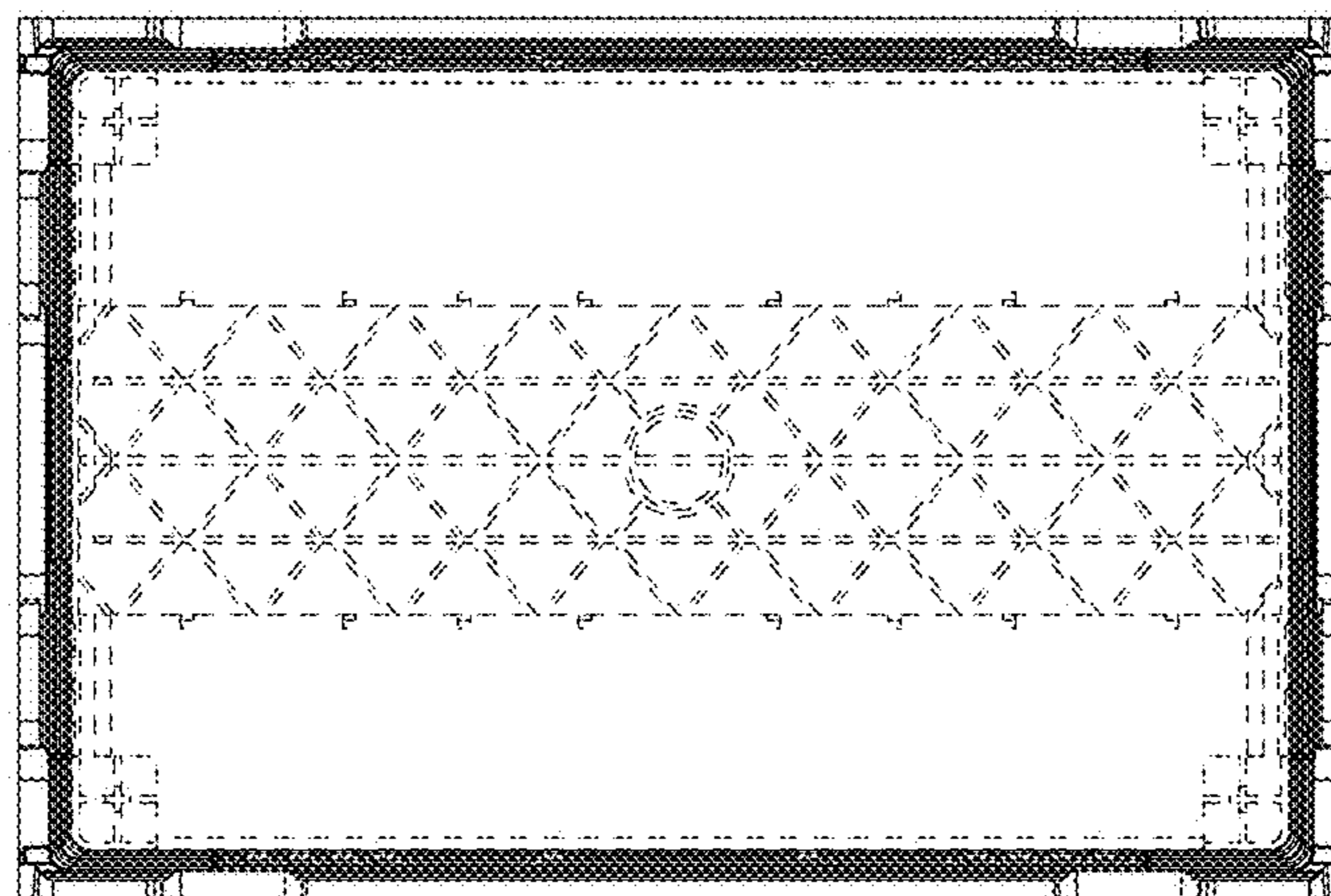

FIG. 7

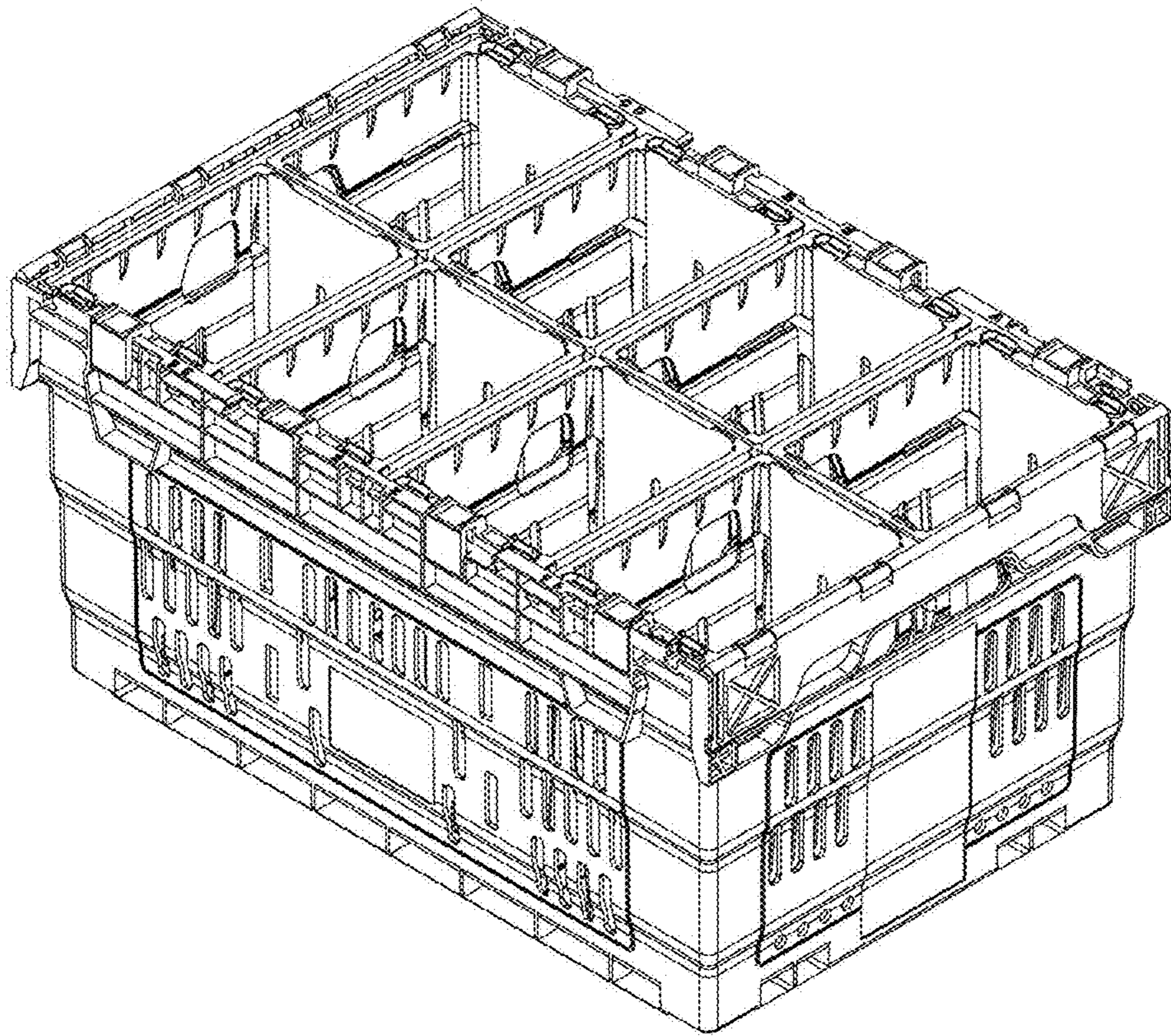

FIG. 8

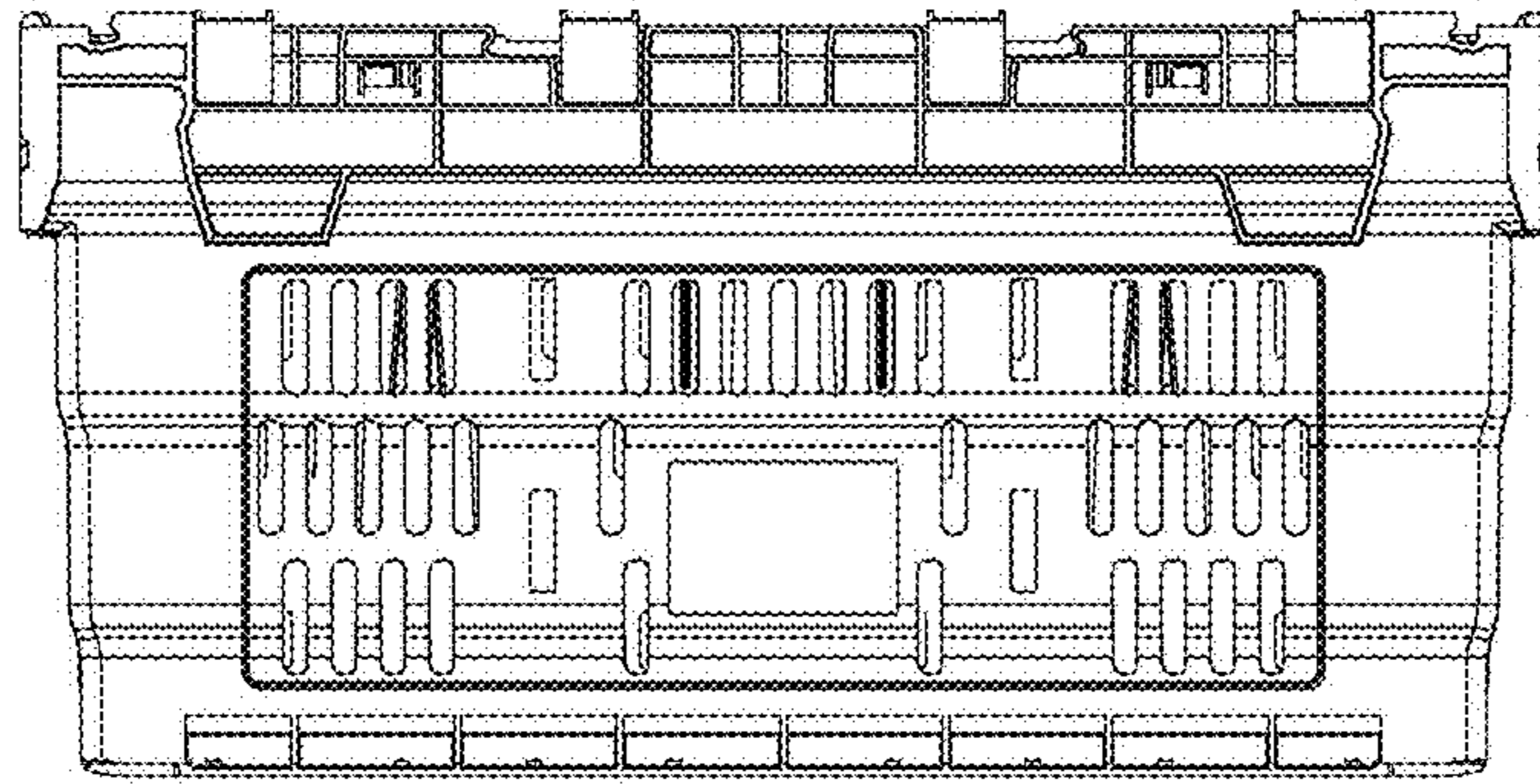

FIG. 9

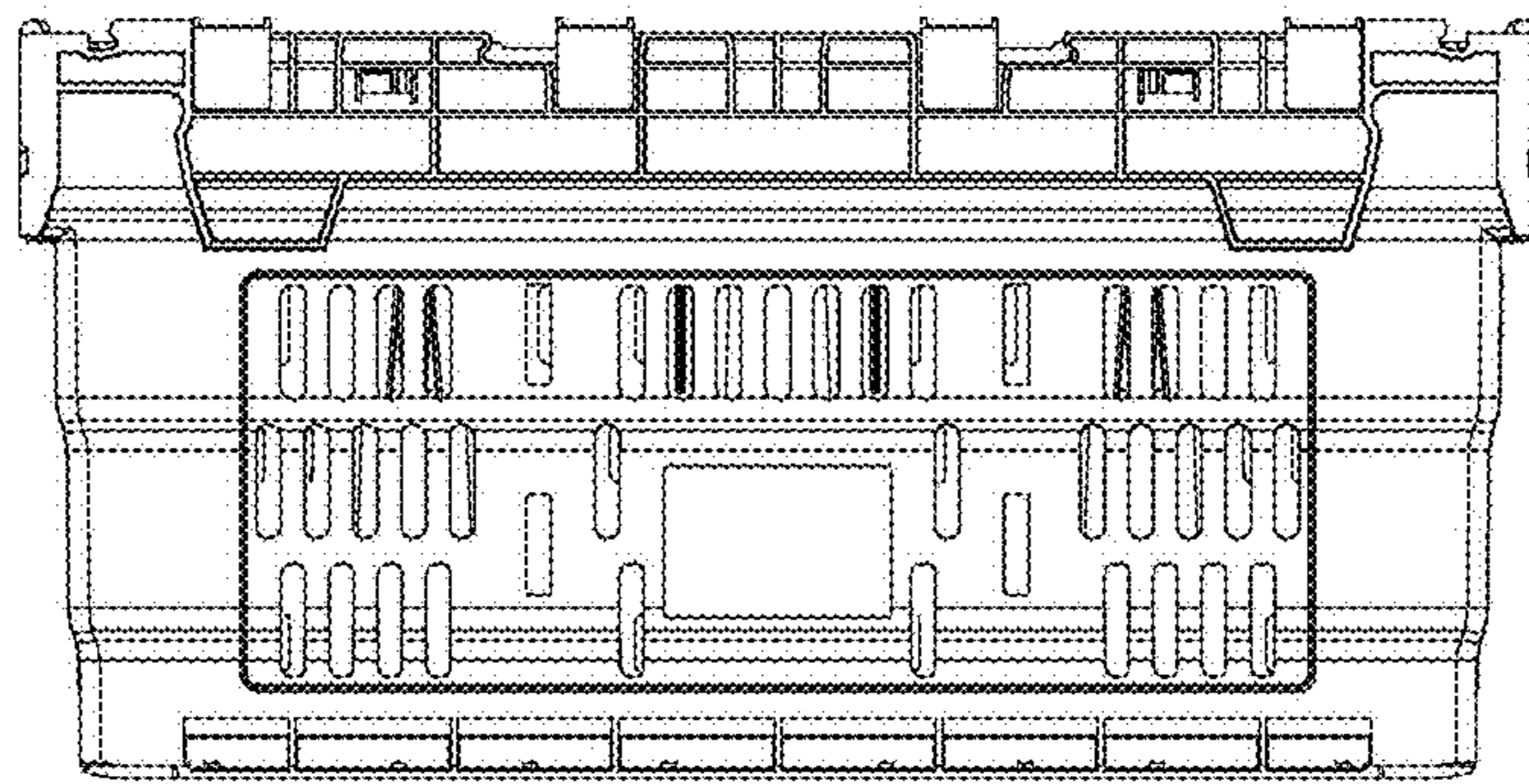

FIG. 10

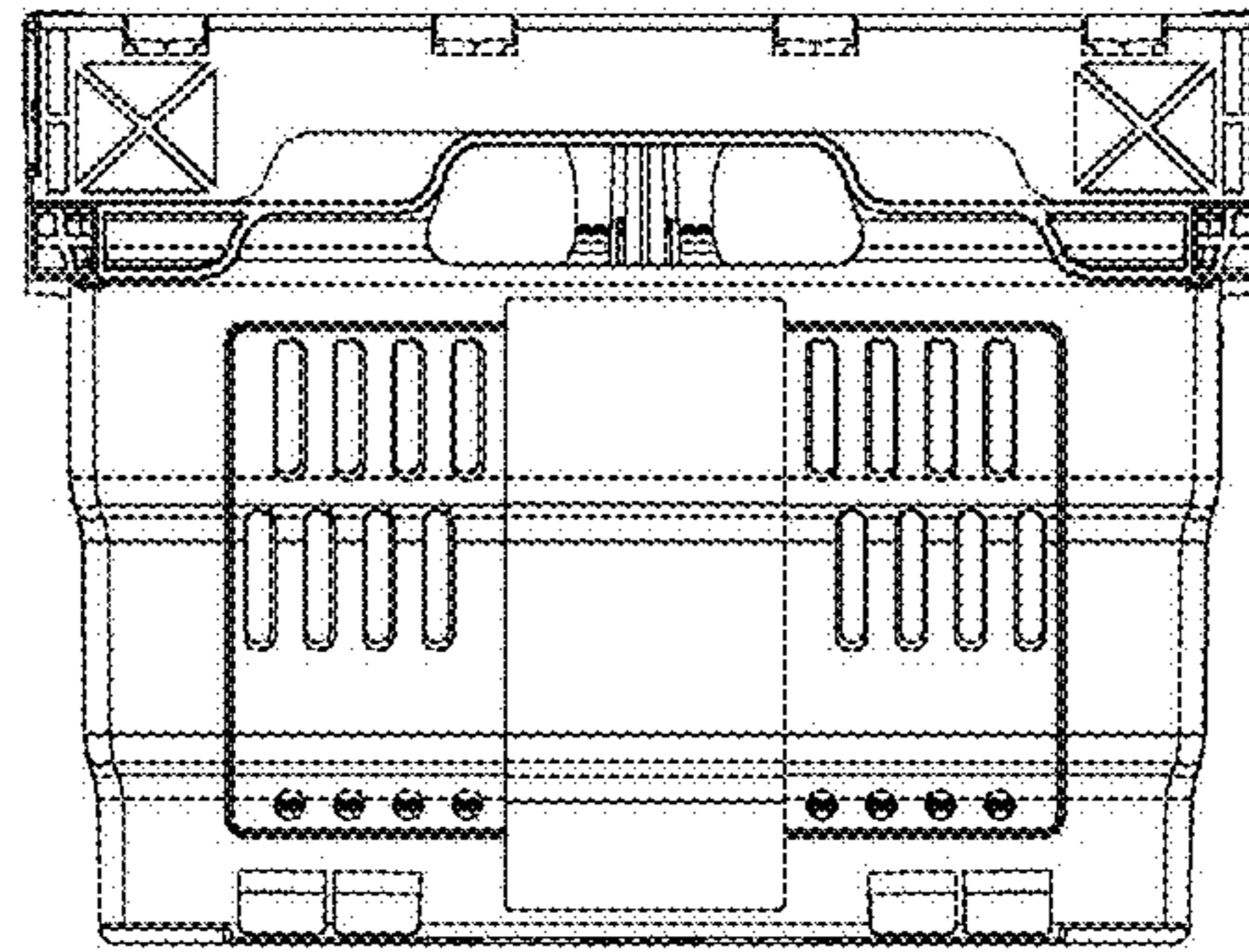

FIG. 11

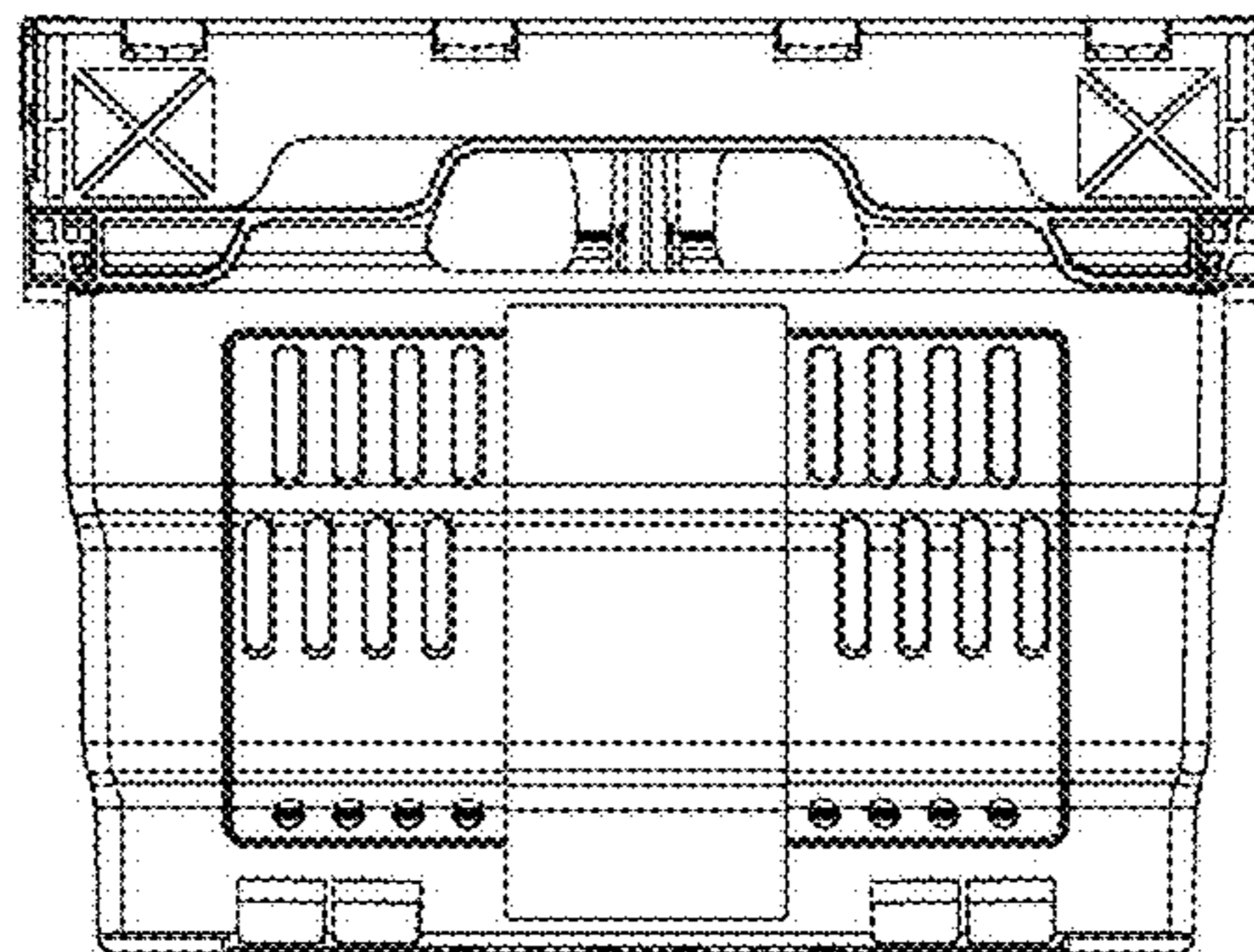

FIG. 12

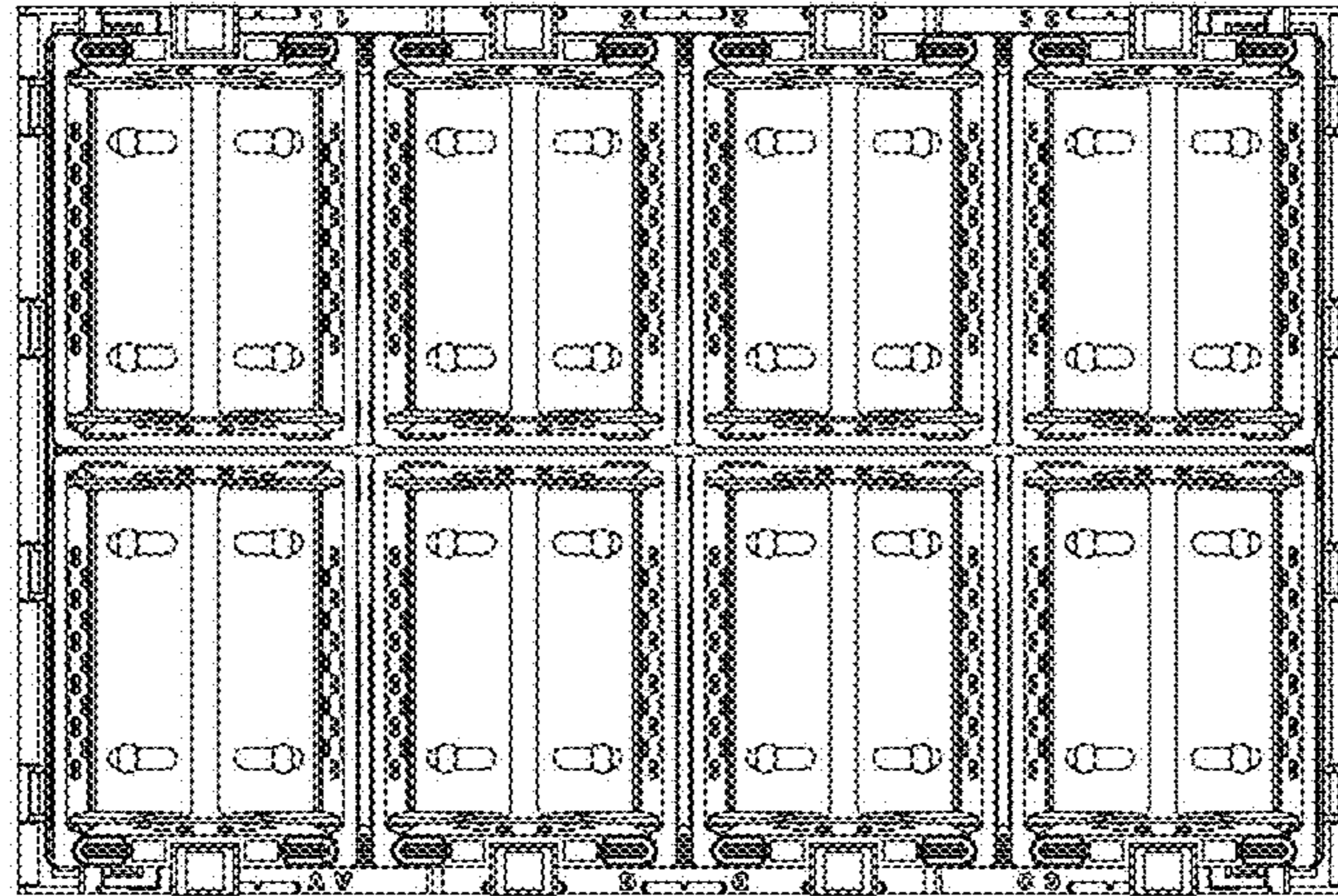

FIG. 13

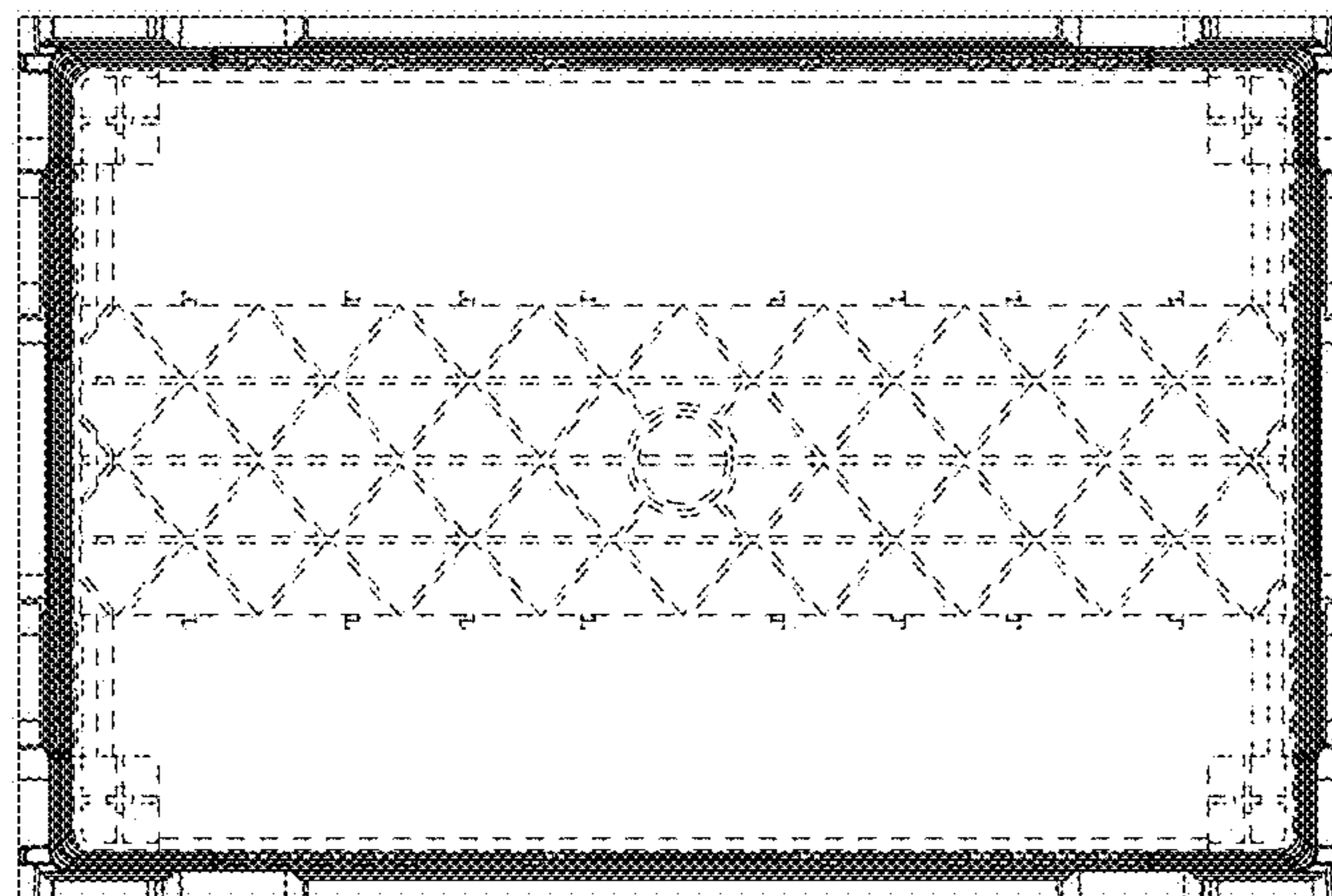

FIG. 14

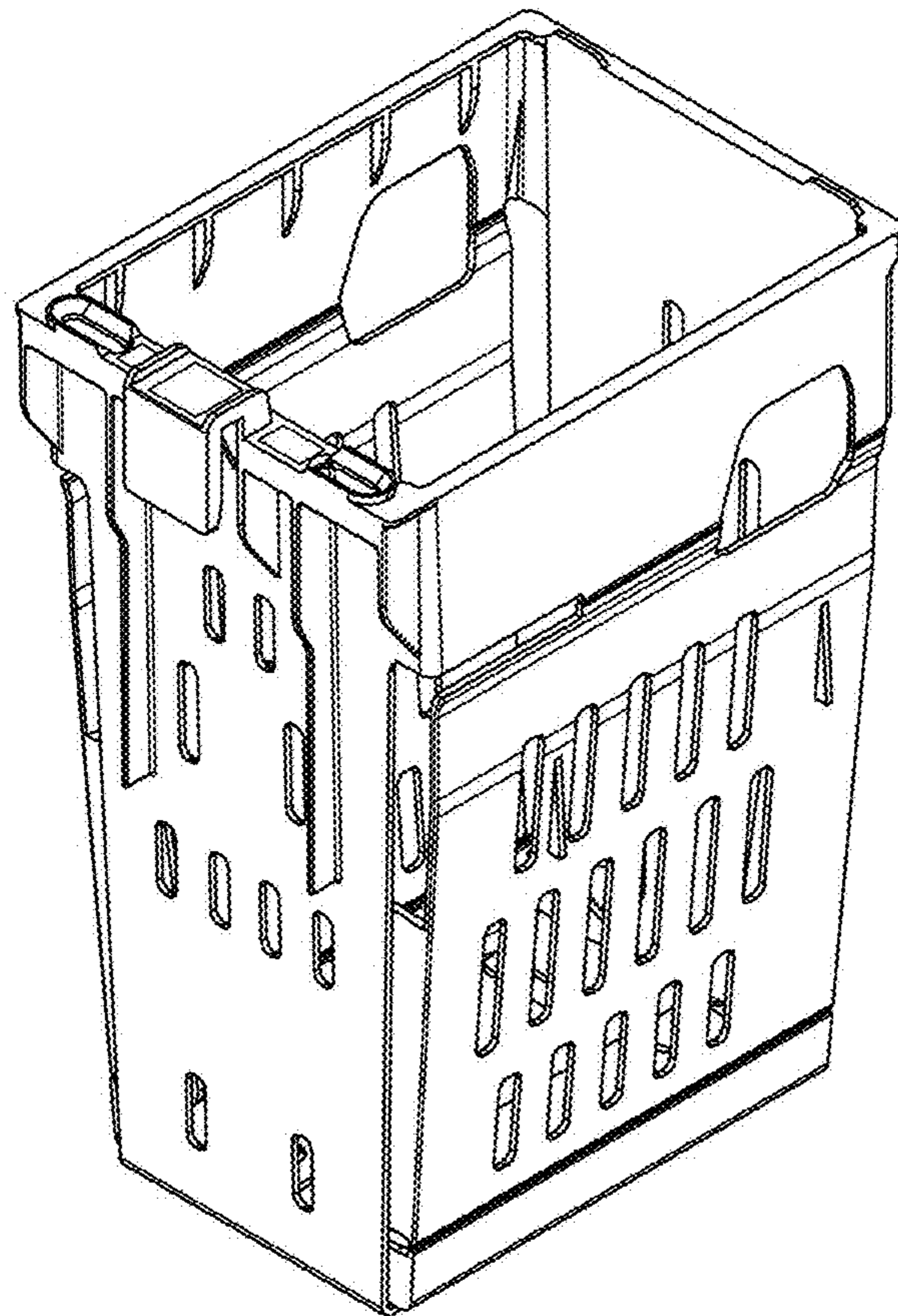

FIG. 15

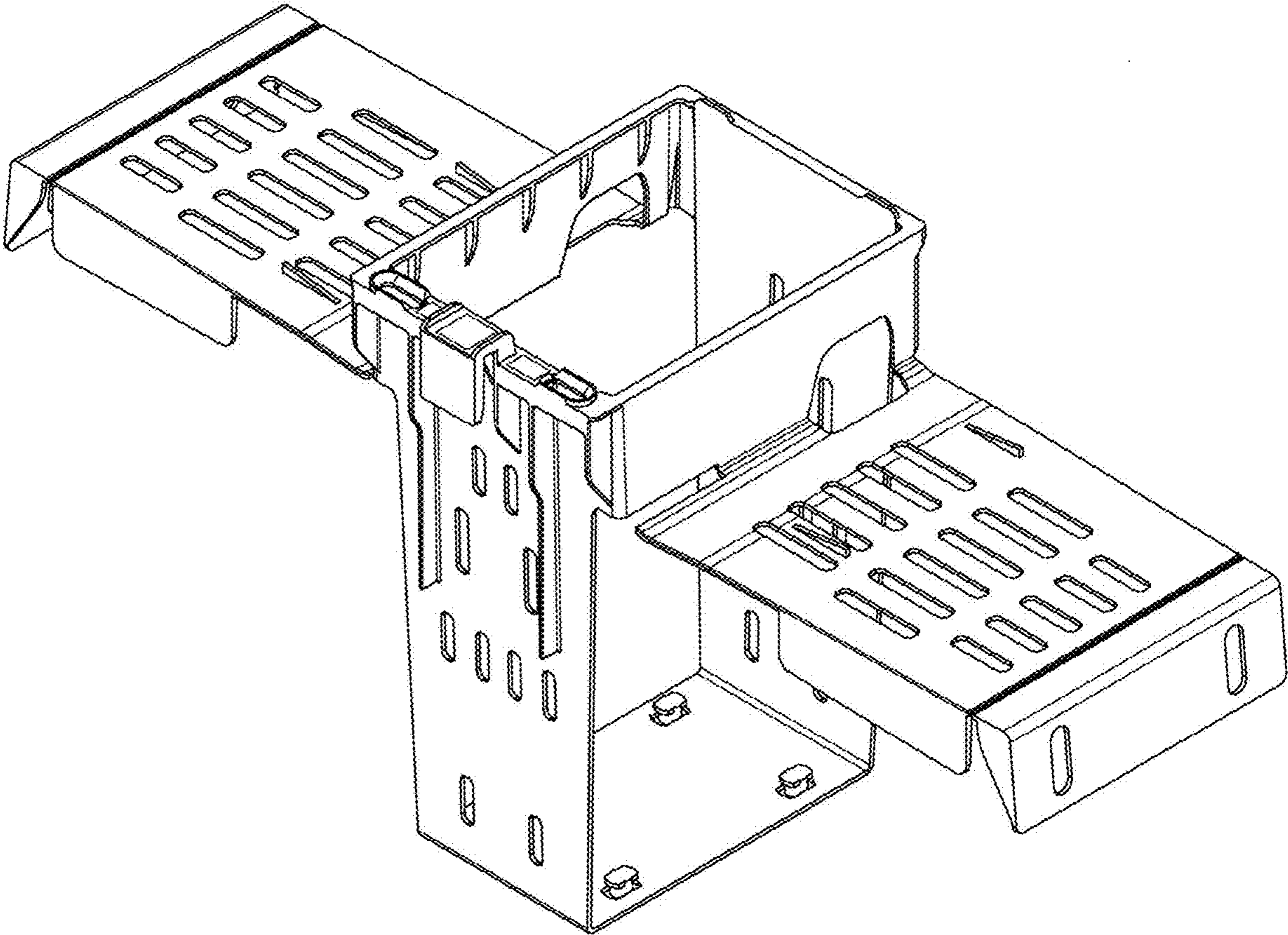

FIG. 16

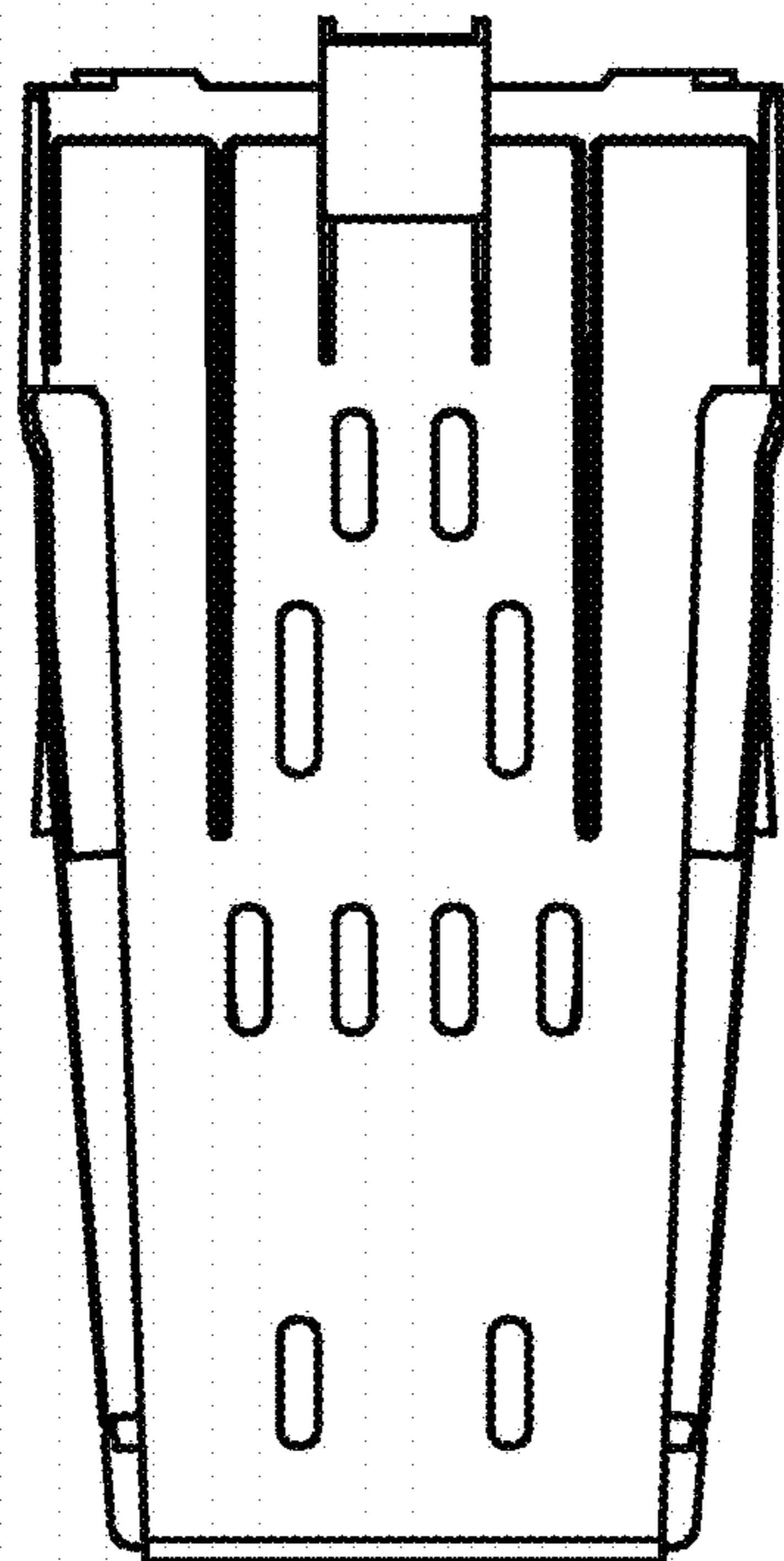

FIG. 17

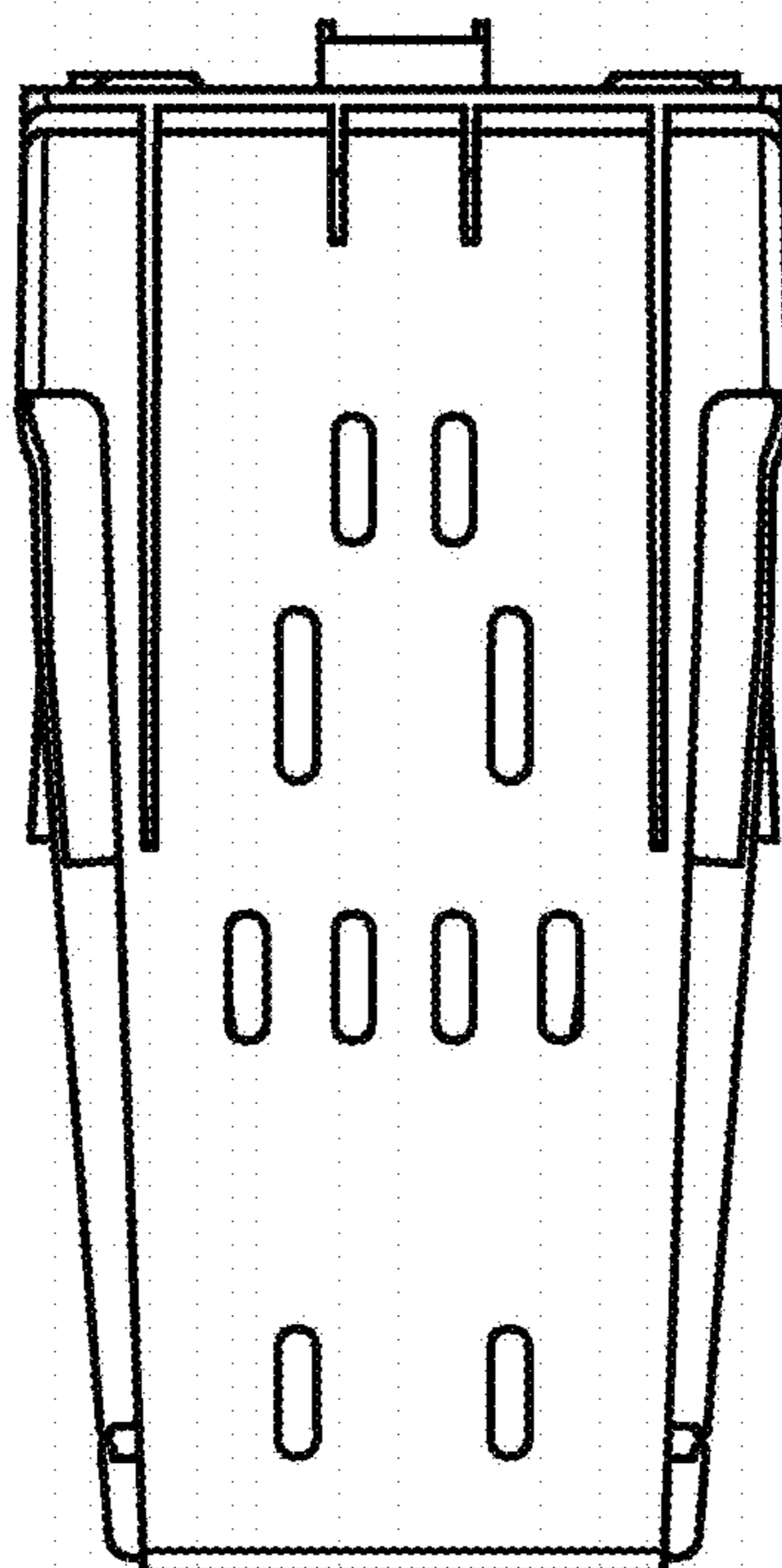

FIG. 18

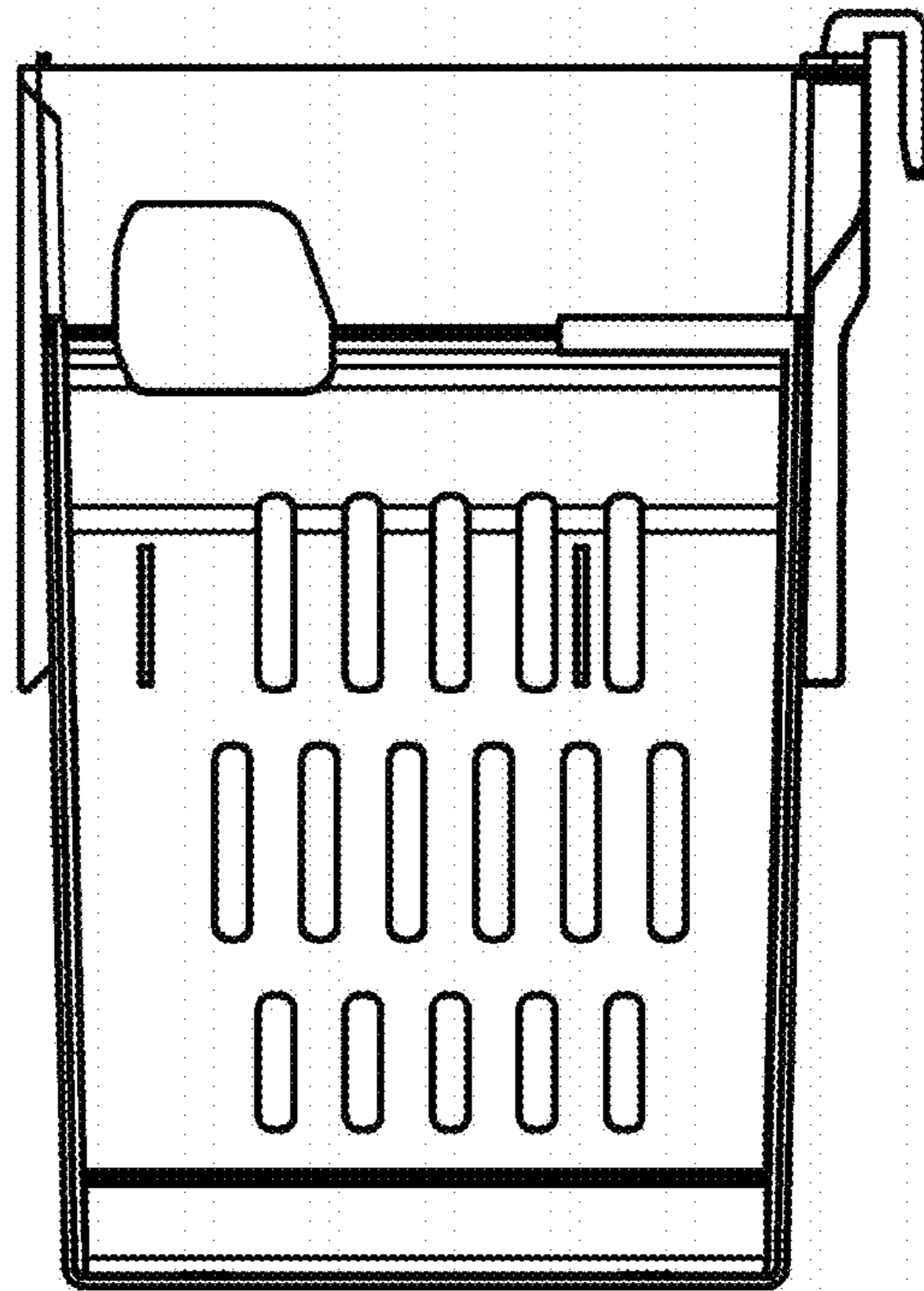

FIG. 19

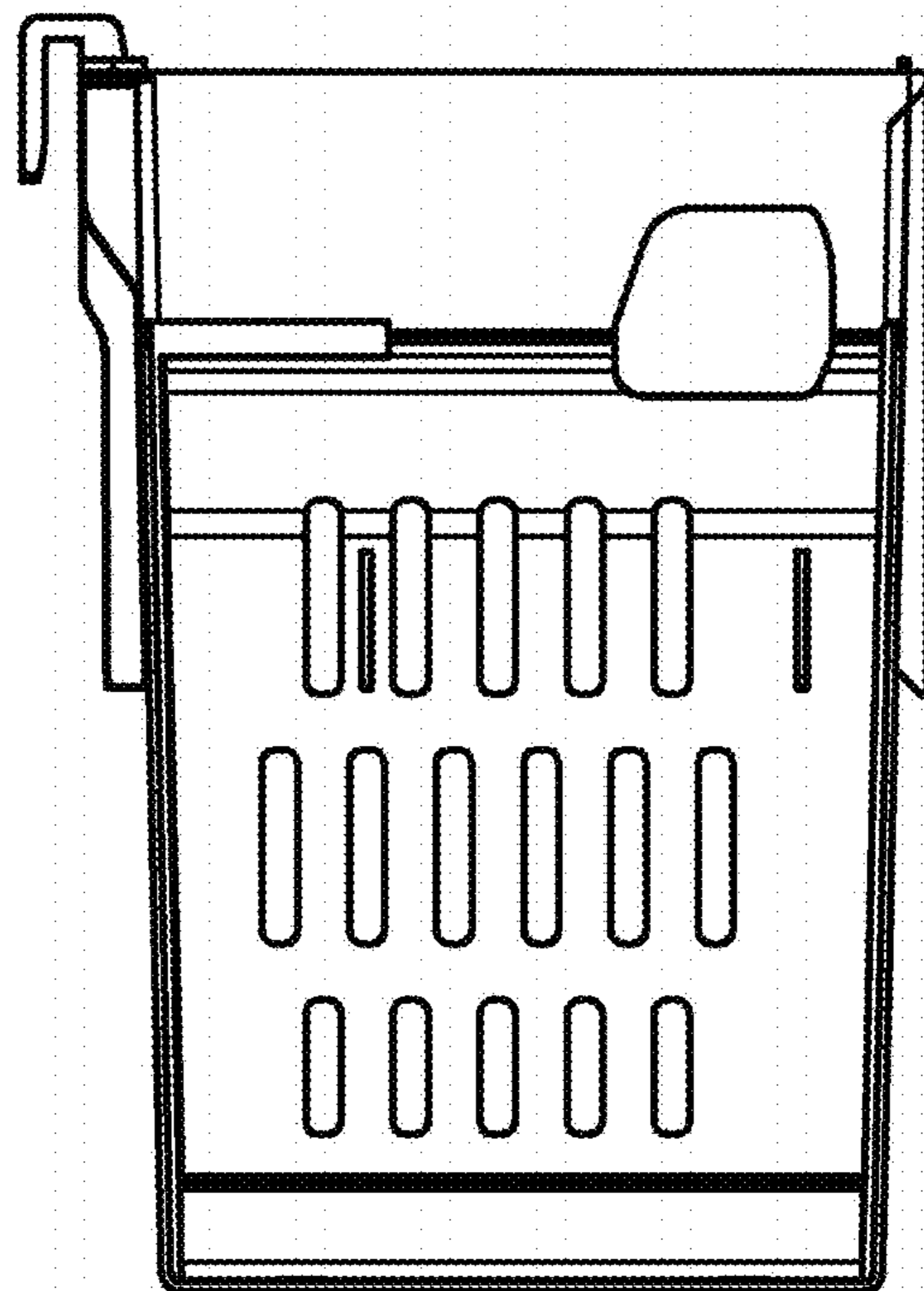

FIG. 20

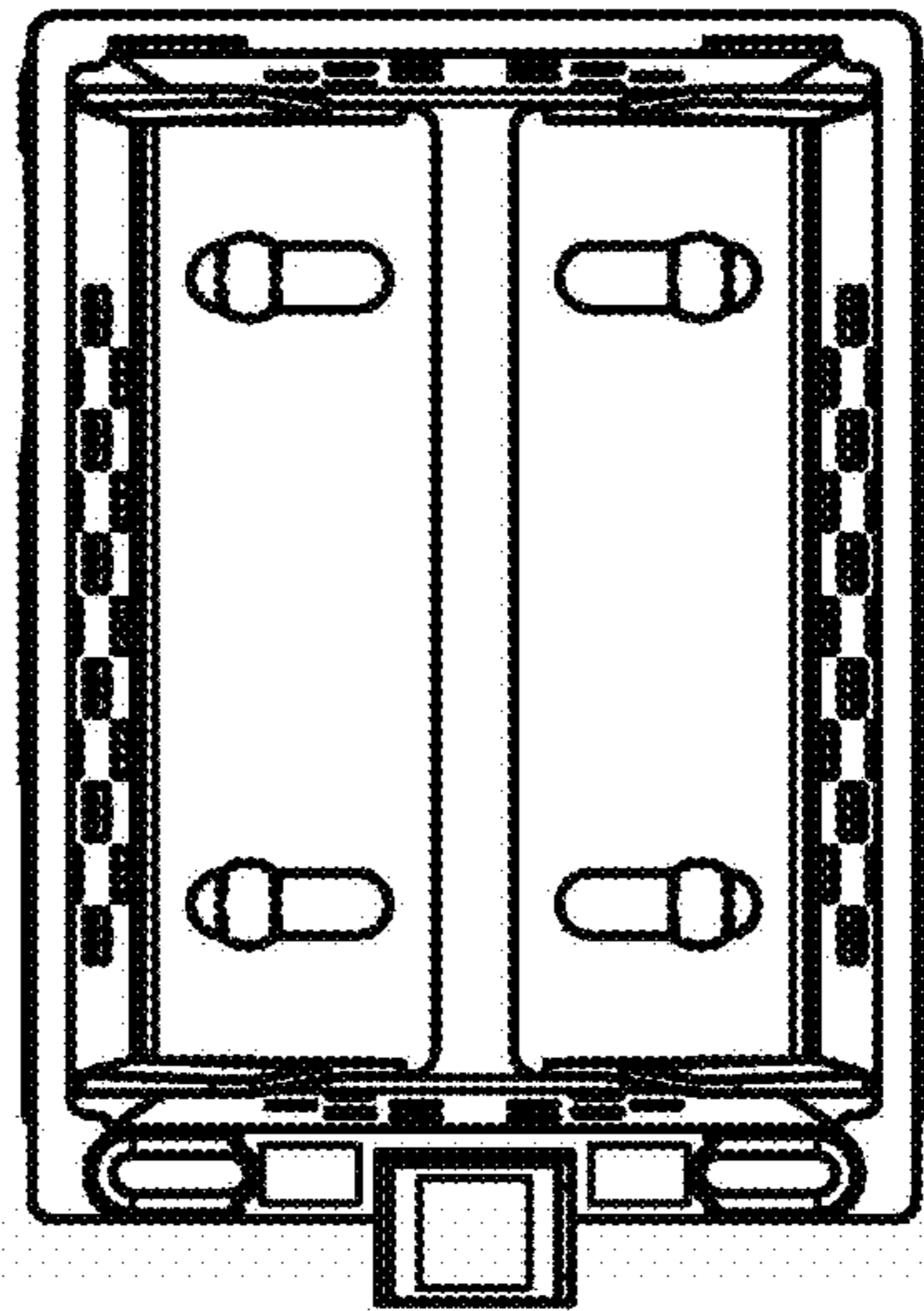

FIG. 21

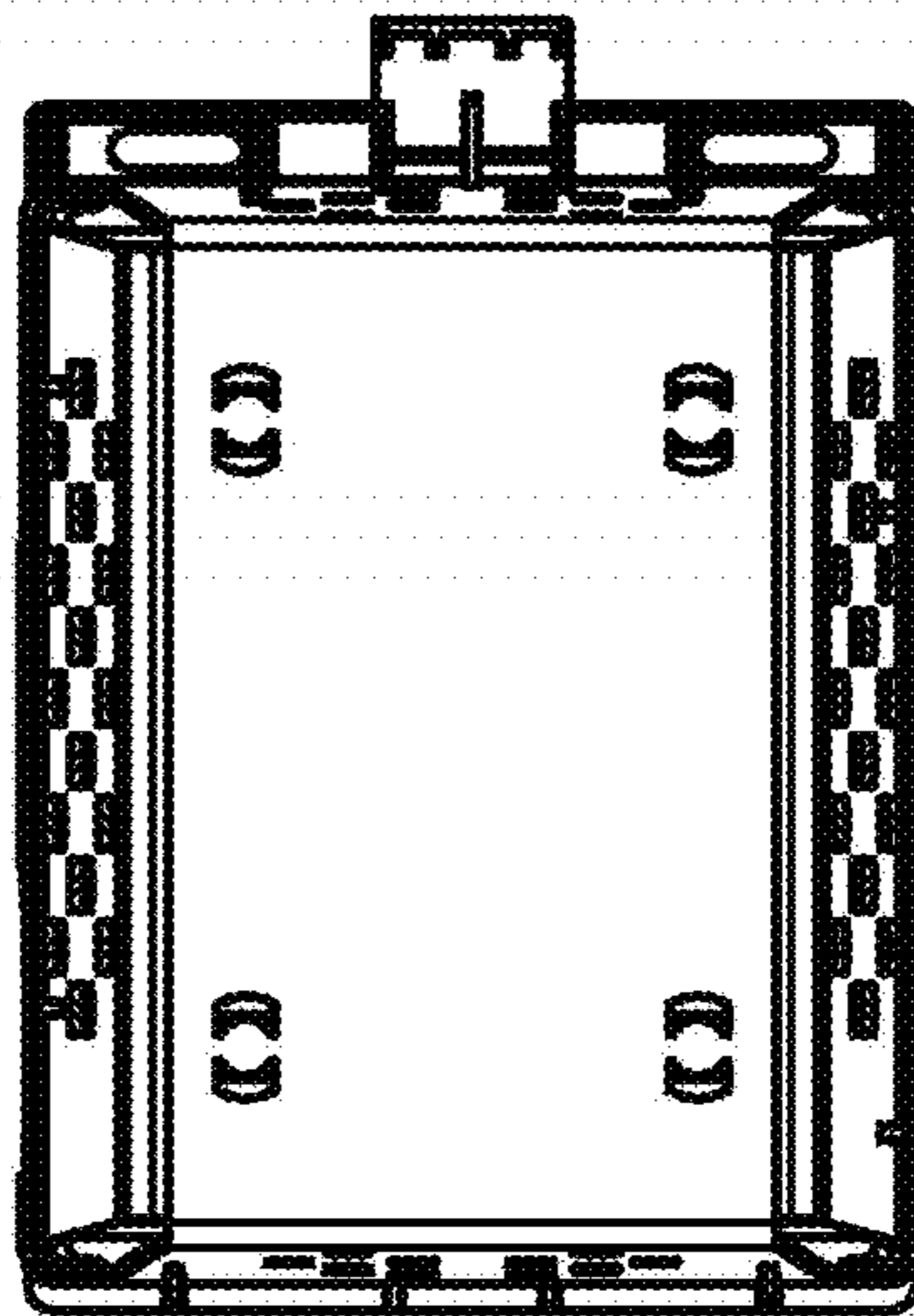

FIG. 22

UNITED STATES PATENT AND TRADEMARK OFFICE
CERTIFICATE OF CORRECTION

PATENT NO. : D951,640 S
APPLICATION NO. : 29/713054
DATED : May 17, 2022
INVENTOR(S) : Richard Kellerer

Page 1 of 1

It is certified that error appears in the above-identified patent and that said Letters Patent is hereby corrected as shown below:

On the Title Page

Item (51)

Please correct the Locarno class to appear as follows:

– LOC (13) Cl. 09-04 –.

Signed and Sealed this
Second Day of August, 2022
Katherine Kelly Vidal

Katherine Kelly Vidal
Director of the United States Patent and Trademark Office