



US00D951633S

(12) **United States Design Patent** (10) **Patent No.:** **US D951,633 S**
Takagaki (45) **Date of Patent:** **** May 17, 2022**

(54) **STORAGE CASE**
(71) Applicant: **Hachiman-kasei co., ltd.**, Gujo (JP)
(72) Inventor: **Maiko Takagaki**, Gujo (JP)
(73) Assignee: **HACHIMAN-KASEI CO., LTD.**,
Gujo (JP)

D439,407 S * 3/2001 Parker D3/276
D499,883 S * 12/2004 Perella D3/276
D619,808 S * 7/2010 Huang D3/276
D619,809 S * 7/2010 Huang D3/276
D677,465 S * 3/2013 Cenzano D3/276
D913,513 S * 3/2021 Liu D24/206
D938,166 S * 12/2021 Kemp D3/286

(**) Term: **15 Years**

CN 304120738 * 5/2017
CN 305157209 * 5/2019
CN 305198817 * 6/2019

(21) Appl. No.: **29/735,174**

FOREIGN PATENT DOCUMENTS

(22) Filed: **May 19, 2020**

OTHER PUBLICATIONS

(30) **Foreign Application Priority Data**

Amazon.ca, Site visited Dec. 29, 2021, Edward Tools Carrying Case, First available Apr. 12, 2017, <https://www.amazon.ca/Edward-Tools-Aluminum-Carrying-Case/dp/B06XC9HSDW> (Year: 2017).*

Nov. 19, 2019 (JP) 2019-025591

(Continued)

(51) **LOC (13) Cl.** **03-01**

(52) **U.S. Cl.**
USPC **D3/276**

Primary Examiner — Brett Miller
Assistant Examiner — Jessica M Gebhart
(74) *Attorney, Agent, or Firm* — WHDA, LLP

(58) **Field of Classification Search**
USPC D3/272, 273, 274, 275, 276, 279, 281,
D3/282, 283, 284, 285, 289, 294, 301,
D3/318, 319, 321, 900, 901, 902, 903,
D3/904, 905, 328; D8/323, 324, 325,
D8/326, 327, 328, 329, 383
CPC A45C 5/00; A45C 5/14; A45C 5/03; A45C
13/03; A44B 11/20

(57) **CLAIM**

The ornamental design for a storage case, as shown and described.

See application file for complete search history.

DESCRIPTION

(56) **References Cited**

FIG. 1 is a top perspective view of a storage case, showing my new design;
FIG. 2 is a bottom perspective view thereof;
FIG. 3 is a front elevational view thereof;
FIG. 4 is a rear elevational view thereof;
FIG. 5 is a left side elevational view thereof;
FIG. 6 is a right side elevational view thereof;
FIG. 7 is a top plan view thereof; and,
FIG. 8 is a bottom plan view thereof.

U.S. PATENT DOCUMENTS

D308,137 S * 5/1990 Grecchi D3/292
5,000,301 A * 3/1991 Grenier A45C 5/02
190/127
6,073,770 A * 6/2000 Park A45C 13/02
206/320

1 Claim, 8 Drawing Sheets

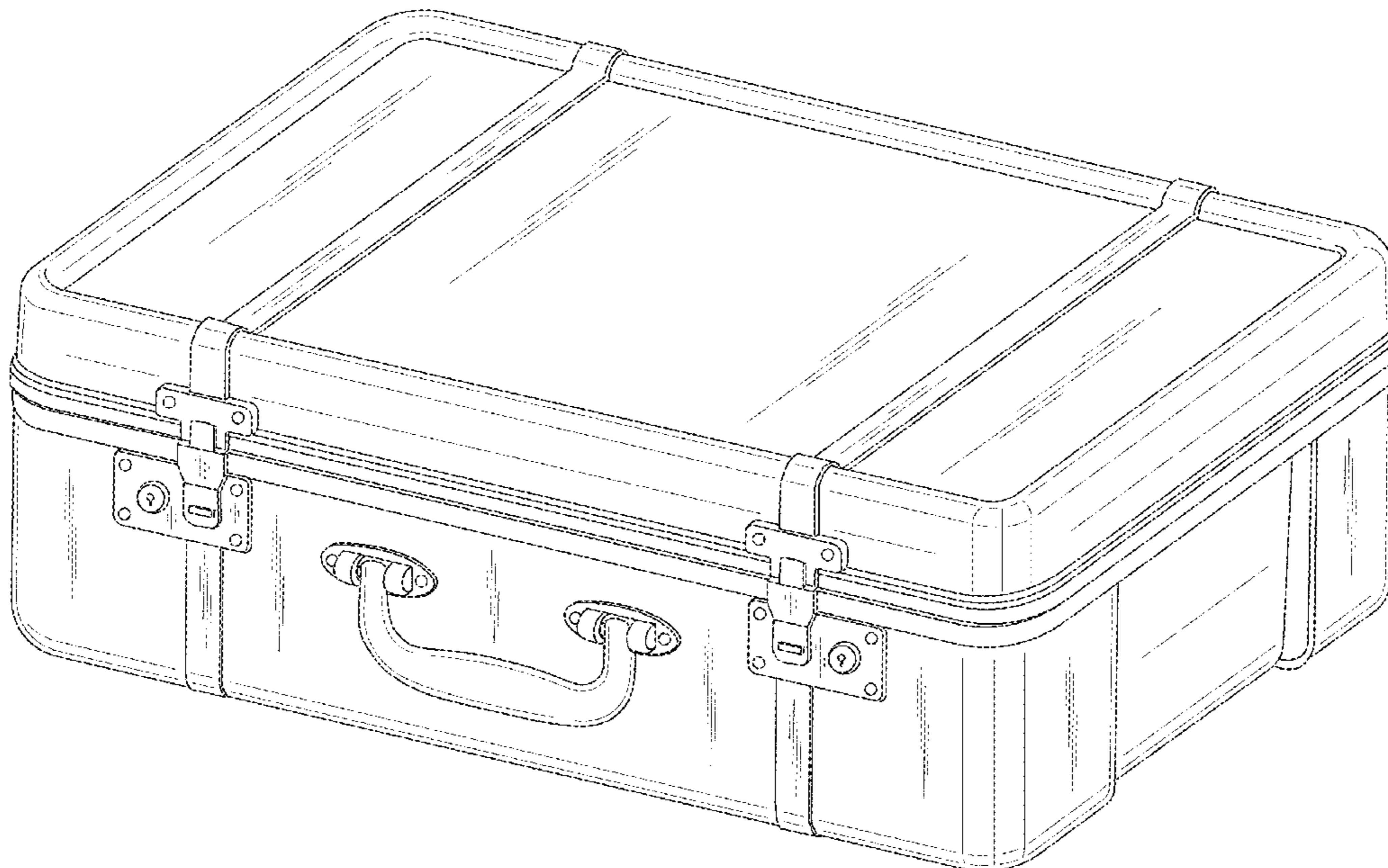

(56)

References Cited

OTHER PUBLICATIONS

Amazon.ca, Site visited Dec. 29, 2021, Vestil Case-1814 Carrying Case with Rounded Corners, First available Apr. 21, 2018, <https://www.amazon.ca/Vestil-CASE-1814-textured-Carrying-corners/dp/B0052PJ39C> (Year: 2018).*

Amazon.ca, Site visited Dec. 29, 2021, Ver Beauty JustCase C4104 Travel Case, First available Aug. 15, 2018, <https://www.amazon.ca/Ver-Beauty-JustCase-Organizer-Leatherette/dp/B07GNCGZN2> (Year: 2018).*

* cited by examiner

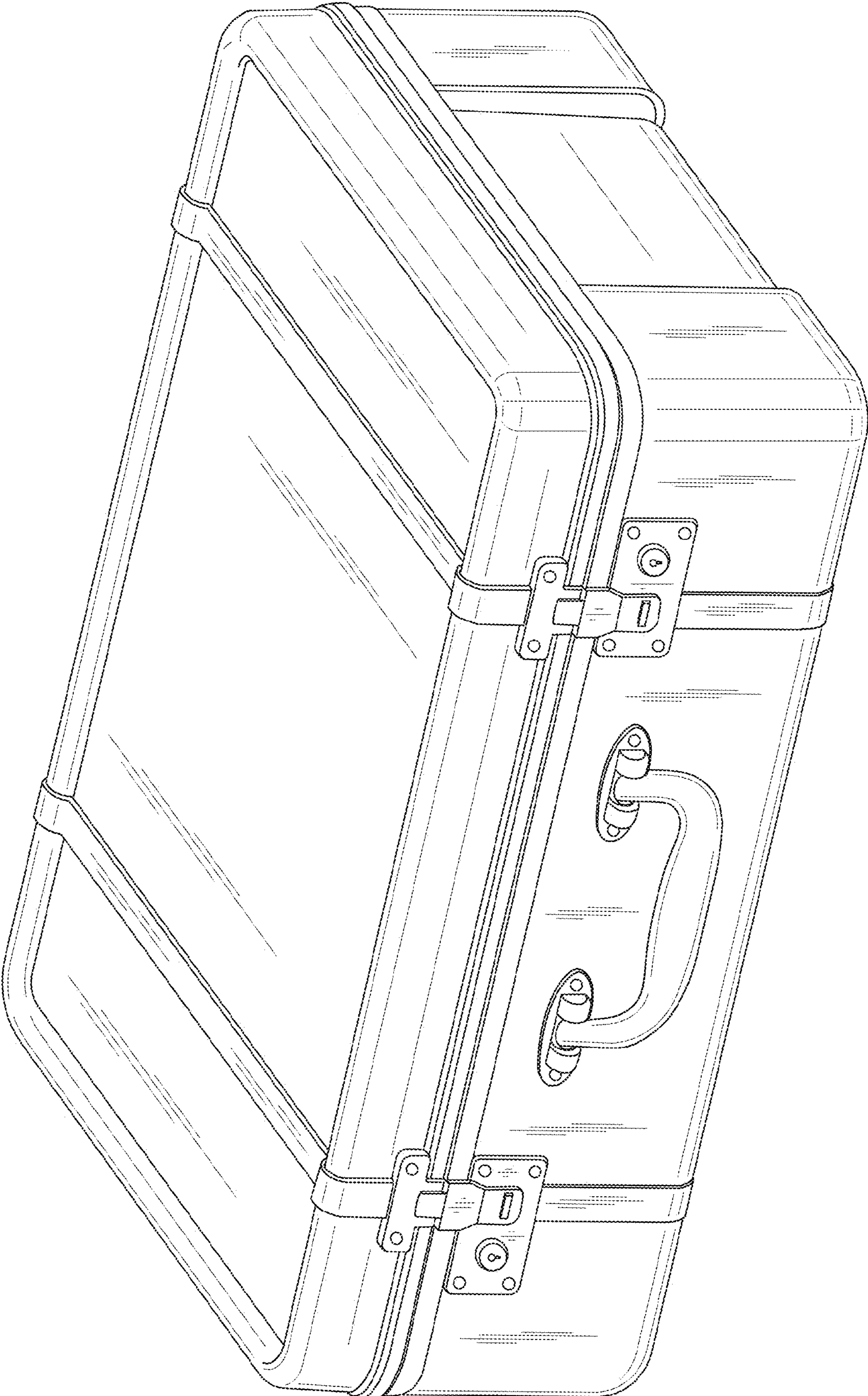

FIG. 1

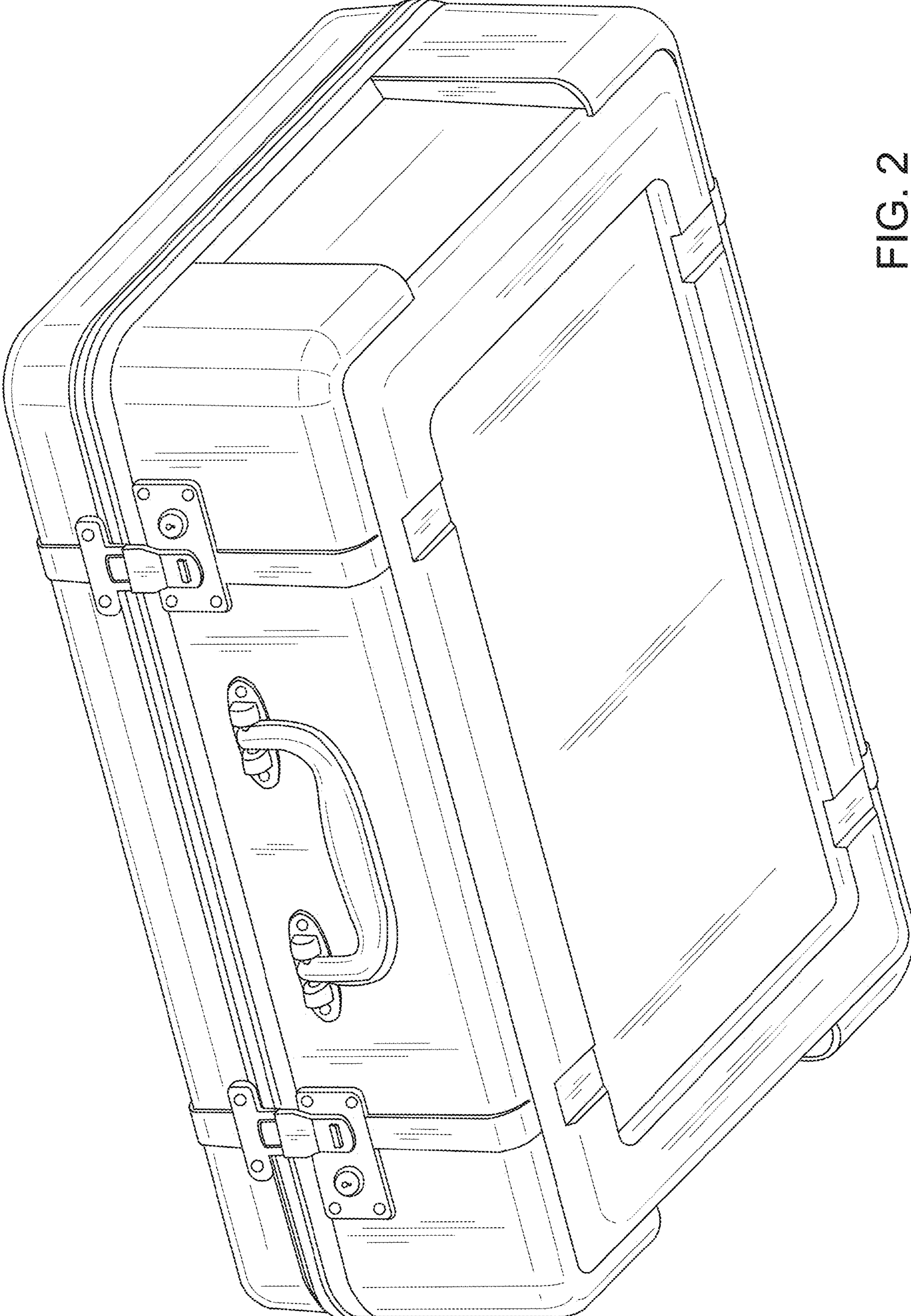

FIG. 2

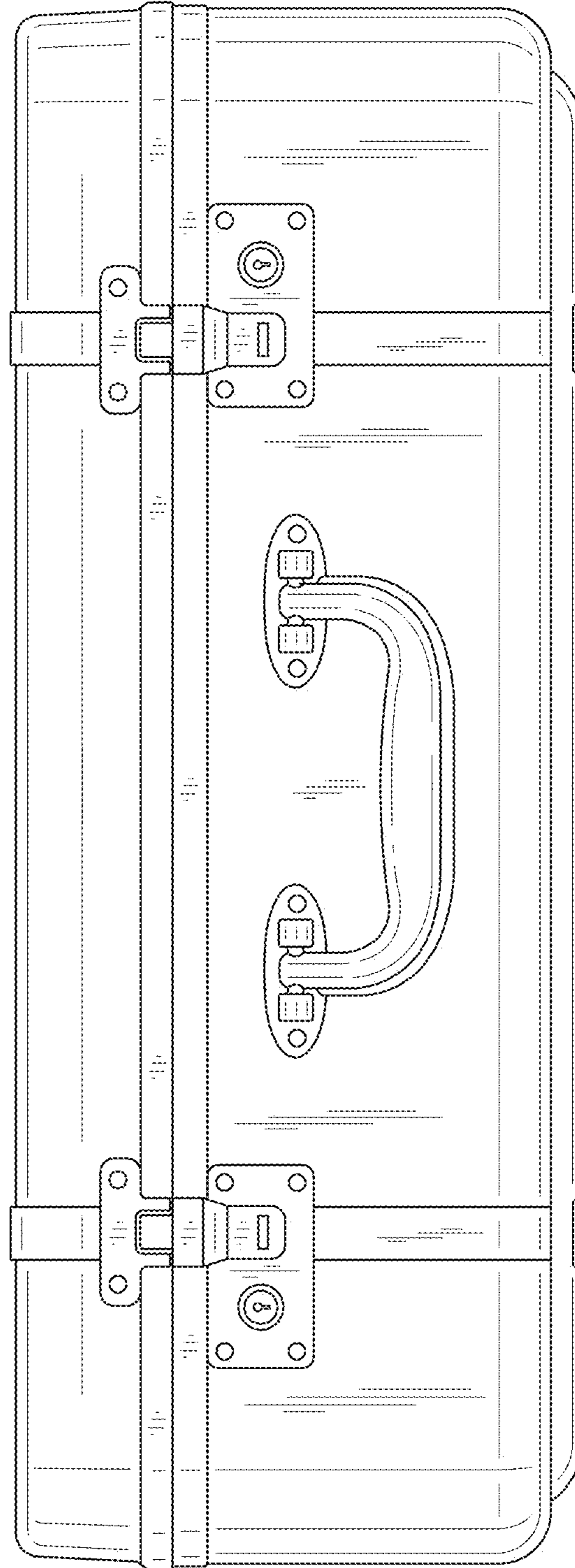

FIG. 3

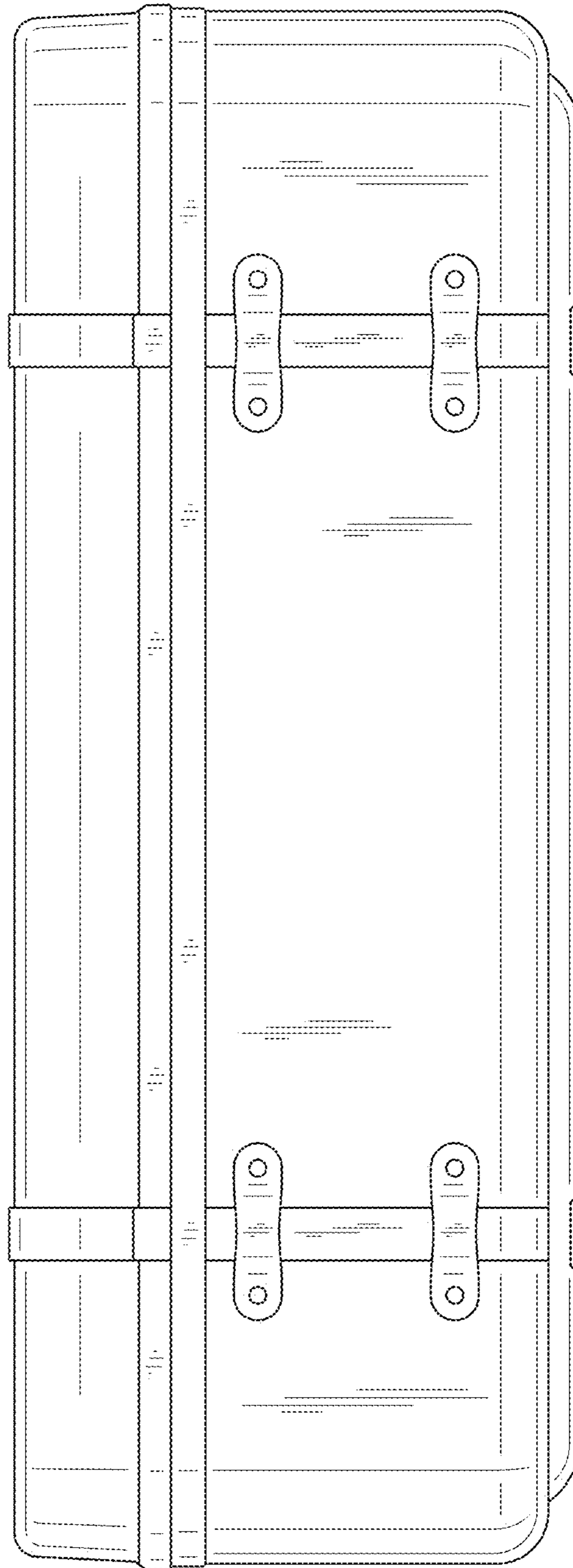

FIG. 4

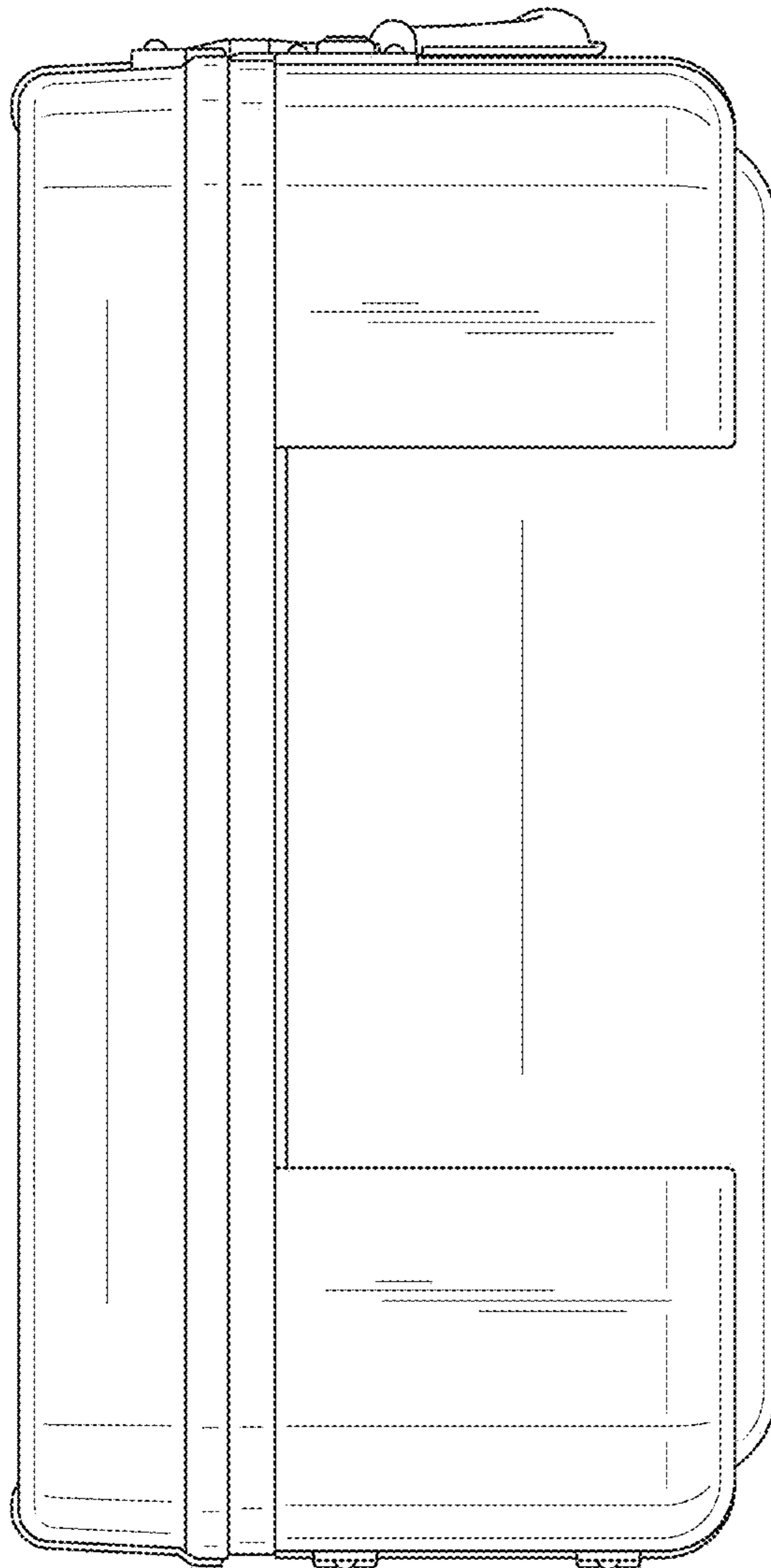

FIG. 5

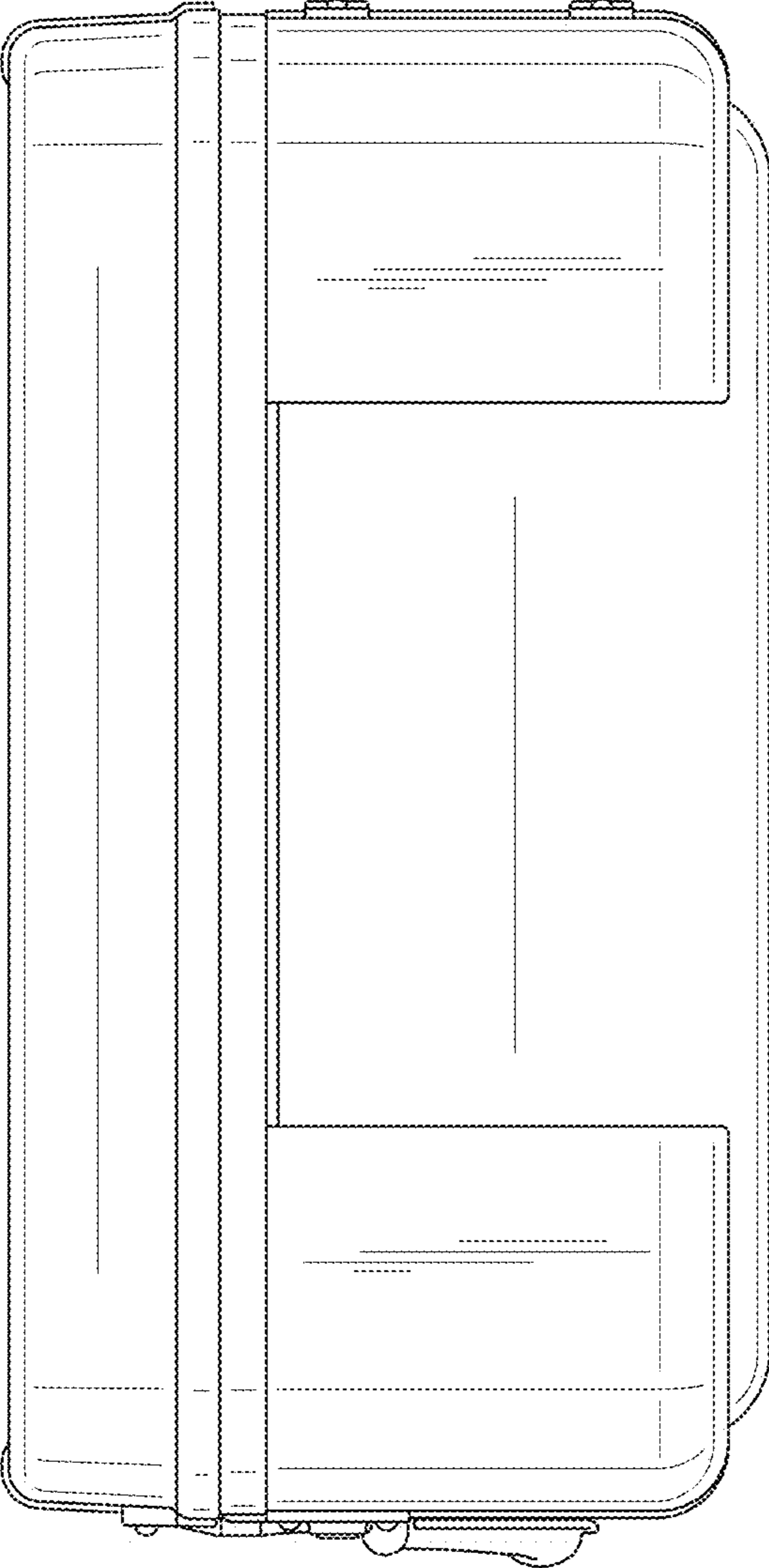

FIG. 6

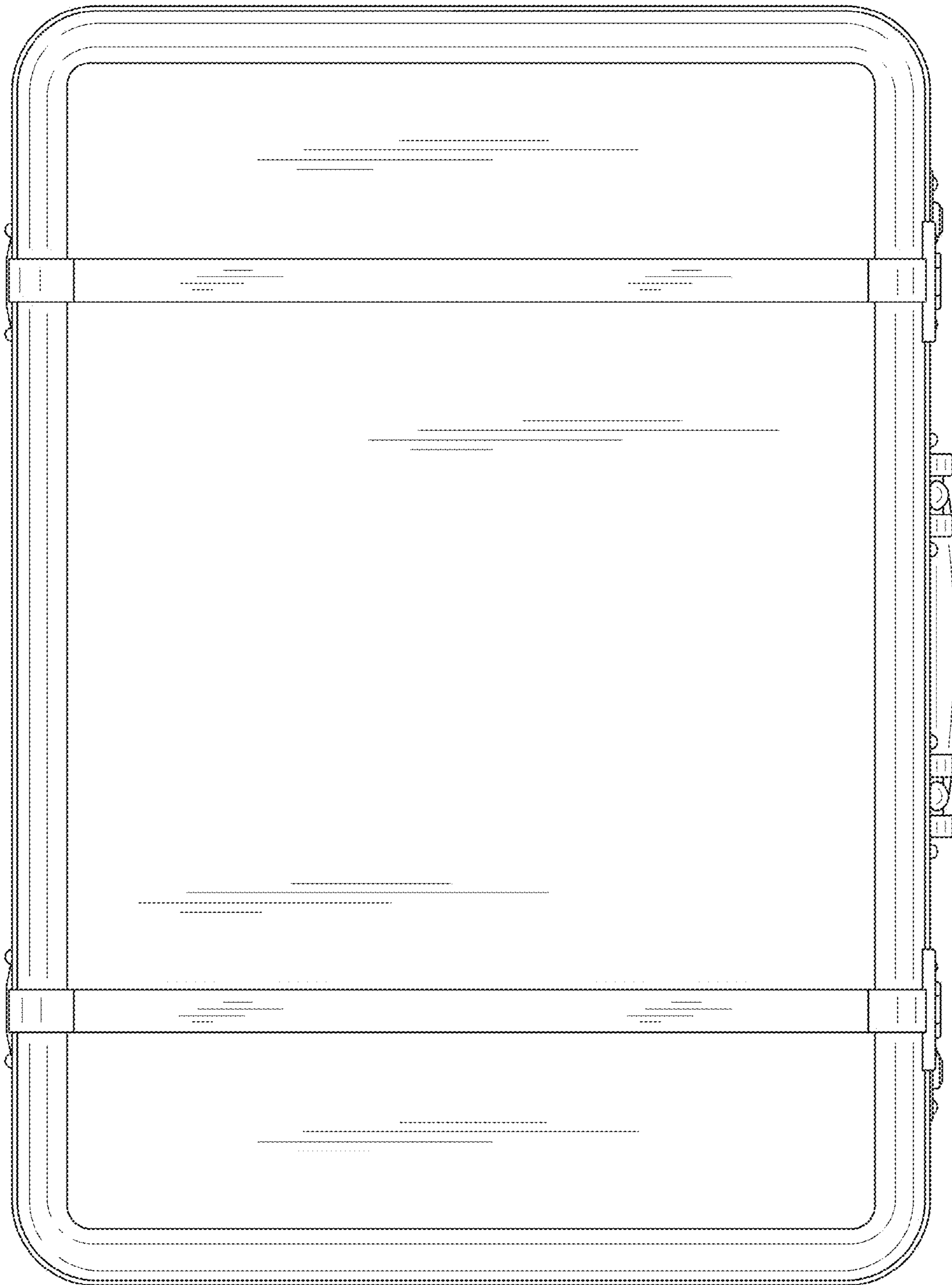

FIG. 7

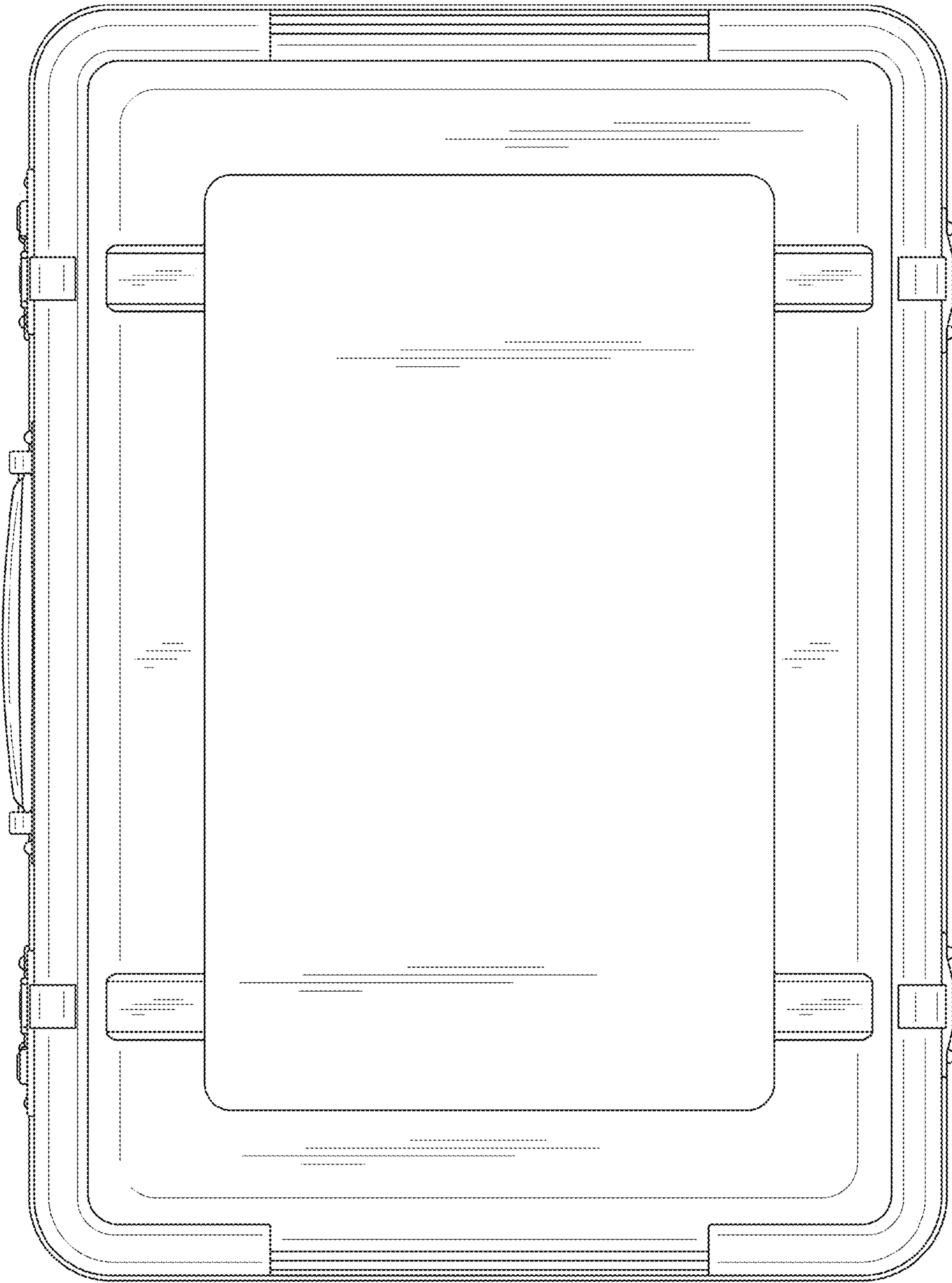

FIG. 8