



US00D951622S

(12) **United States Design Patent**
Chang

(10) **Patent No.:** **US D951,622 S**
(45) **Date of Patent:** **** May 17, 2022**

- (54) **SHOELACE BUCKLE**
- (71) Applicant: **Shuyun Chang**, Anhui (CN)
- (72) Inventor: **Shuyun Chang**, Anhui (CN)
- (**) Term: **15 Years**
- (21) Appl. No.: **29/780,803**
- (22) Filed: **Apr. 27, 2021**
- (51) **LOC (13) Cl.** **02-04**
- (52) **U.S. Cl.**
USPC **D2/978**
- (58) **Field of Classification Search**
USPC D2/896-899, 902, 907, 946, 976, 978;
D8/349, 382, 354, 383
CPC .. A43C 7/00; A43C 11/00; A43C 7/08; A43C
7/005; A43B 3/0021; F16G 11/101; F16G
11/105
See application file for complete search history.

8,932,330 B2 * 1/2015 Bonutti A61B 17/0487
606/232
D773,923 S * 12/2016 Ishii D8/383
D773,924 S * 12/2016 Ishii D8/383
D816,319 S * 5/2018 Cooper D2/978
10,076,160 B2 * 9/2018 Burns A43C 11/165
D840,661 S * 2/2019 Schenone D2/978
D902,576 S * 11/2020 Sutton D2/978
D907,354 S 1/2021 Wu

* cited by examiner

Primary Examiner — Rashida C. Walshon

(57) **CLAIM**

The ornamental design for a shoelace buckle, as shown and described.

DESCRIPTION

FIG. 1 is a front and top perspective view of a shoelace buckle, showing my new design;
 FIG. 2 is a front elevation view of
 FIG. 3 is a rear elevation view thereof;
 FIG. 4 is a left side elevation view thereof;
 FIG. 5 is a right side elevation view thereof; and,
 FIG. 6 is another perspective view thereof.
 The broken lines in the figures illustrate portions of the shoelace buckle that form no part of the claimed design.

1 Claim, 6 Drawing Sheets

- (56) **References Cited**
U.S. PATENT DOCUMENTS
3,187,396 A * 6/1965 Carroll A41D 25/022
2/148
D399,045 S * 10/1998 Liston D2/978
D477,776 S * 7/2003 Pontaoe D8/396
6,802,439 B2 * 10/2004 Azam A43B 5/0401
36/50.5
D549,087 S * 8/2007 Pontaoe D8/383
D626,322 S * 11/2010 Servettaz D2/978

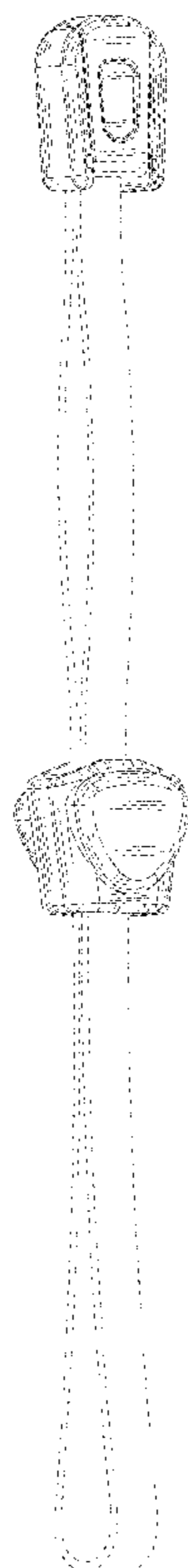

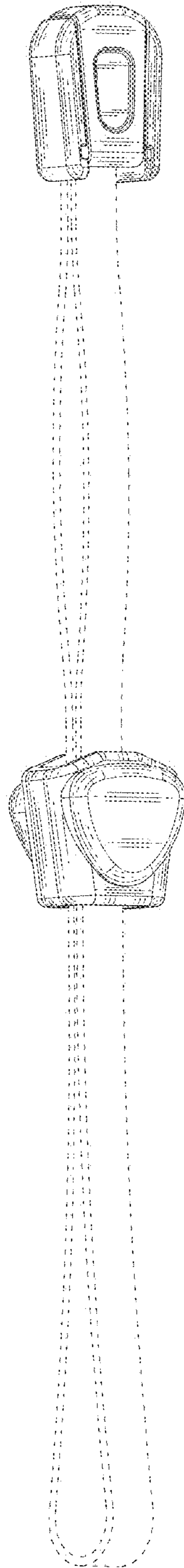

FIG. 1

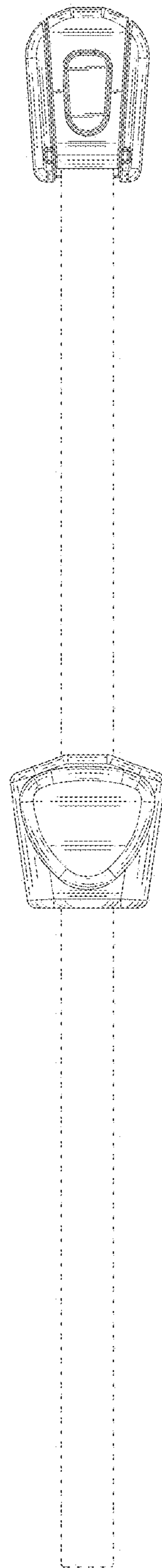

FIG. 2

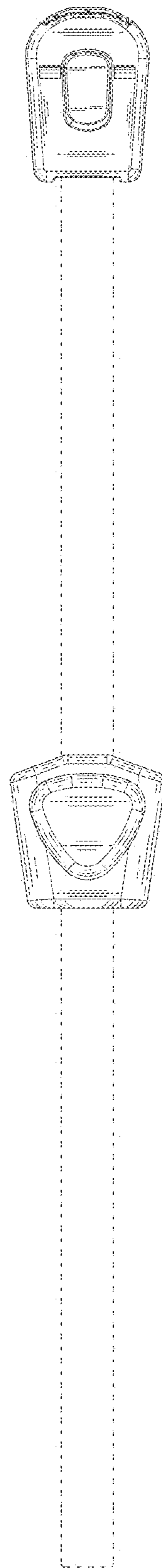

FIG. 3

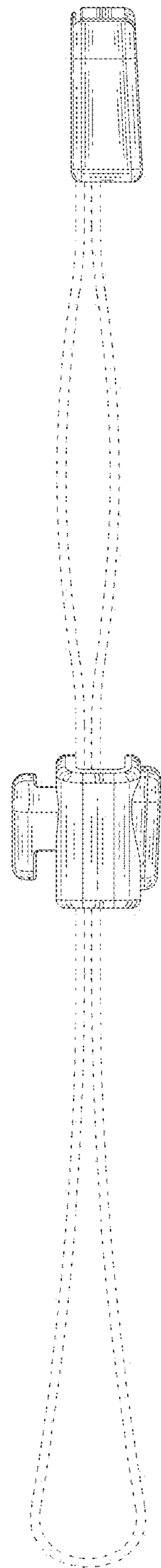

FIG. 4

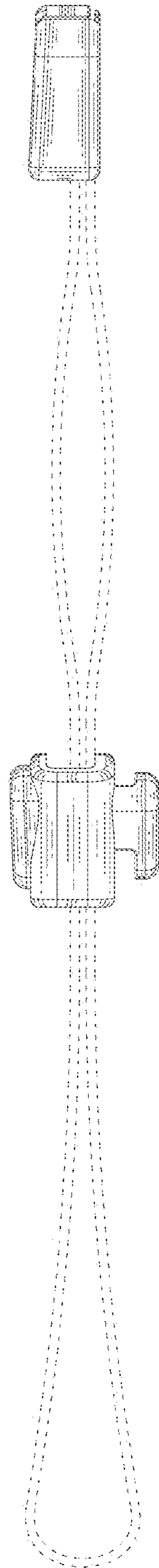

FIG. 5

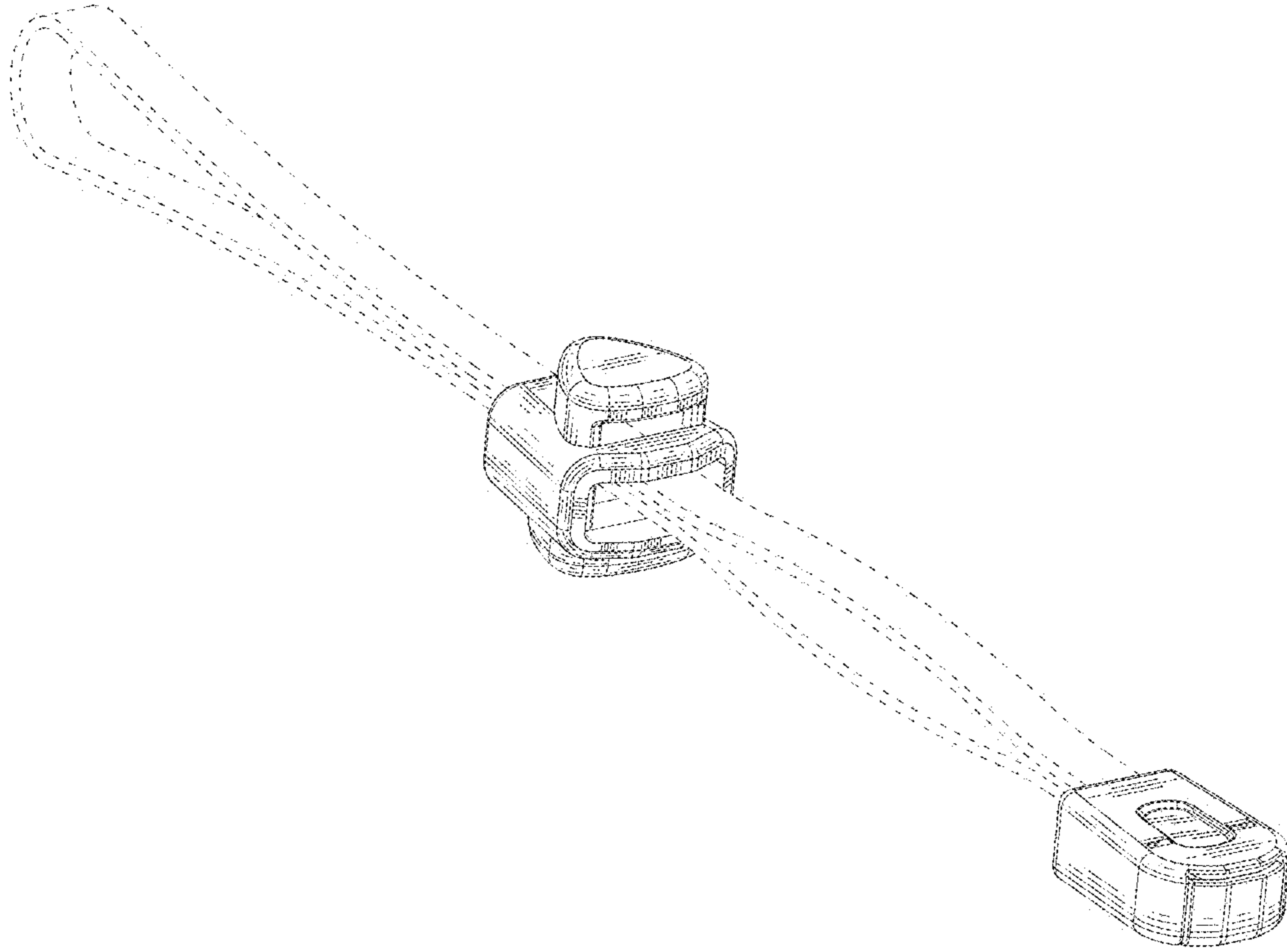

FIG. 6