



US00D951543S

(12) **United States Design Patent** (10) **Patent No.:** **US D951,543 S**
Luo (45) **Date of Patent:** **** May 10, 2022**

(54) **HAIR REMOVER**
(71) Applicant: **Dewei Luo**, Shenzhen (CN)
(72) Inventor: **Dewei Luo**, Shenzhen (CN)
(**) Term: **15 Years**
(21) Appl. No.: **29/736,280**
(22) Filed: **May 29, 2020**

(30) **Foreign Application Priority Data**

Dec. 19, 2019 (CN) 201930712530.2

(51) **LOC (13) Cl.** **28-03**

(52) **U.S. Cl.**
USPC **D28/53**

(58) **Field of Classification Search**
USPC D28/10, 45, 49-54
CPC B26B 19/148; B26B 19/38; B26B 19/384;
B26B 19/00; B26B 19/04; B26B 19/06;
B26B 19/10; B26B 19/12; B26B 19/14;
B26B 19/20; B26B 19/3853; B26B 21/00;
A45D 26/00; A45D 26/008; A45D
26/0061
See application file for complete search history.

(56) **References Cited**

U.S. PATENT DOCUMENTS

D283,736 S * 5/1986 Wahl D28/53
D294,407 S * 2/1988 Ullmann D28/53
D302,601 S * 8/1989 Uchida D28/53
D304,627 S * 11/1989 Yonesawa D28/53
D320,673 S * 10/1991 Sterk D28/52
D363,809 S * 10/1995 Bone B26B 19/06
D28/53

D403,468 S * 12/1998 Smith D28/53
D413,182 S * 8/1999 Smith D28/53
D456,947 S * 5/2002 Hoffman D28/53
D683,074 S * 5/2013 Julemont D28/53
D698,082 S * 1/2014 Colin D28/53
D911,610 S * 2/2021 Zhang D28/50
D931,538 S * 9/2021 Marquez D28/53
2018/0236673 A1 * 8/2018 Hoffmann B26B 19/20
2018/0290318 A1 * 10/2018 Khubani B26B 19/3833
2018/0345510 A1 * 12/2018 Julemont B26B 19/3853

* cited by examiner

Primary Examiner — Alison M Ofstun

(57) **CLAIM**

The ornamental design for a hair remover, as shown and described.

DESCRIPTION

FIG. 1 is a perspective view of a hair remover showing my new design;
FIG. 2 is another perspective view thereof;
FIG. 3 is a front elevational view thereof;
FIG. 4 is a rear elevational view thereof;
FIG. 5 is a left side elevational view thereof;
FIG. 6 is a right side elevational view thereof;
FIG. 7 is a top plan view thereof;
FIG. 8 is a bottom plan view thereof;
FIG. 9 is a perspective view of the hair remover, shown with the cap on; and,
FIG. 10 is an enlarged view of the encircled portion 10 of FIG. 1.

The evenly spaced broken lines in the drawings illustrate portions of the hair remover that form no part of the claimed design. The dot-dash broken lines illustrate enlarged view indicators and form no part of the claimed design.

1 Claim, 10 Drawing Sheets

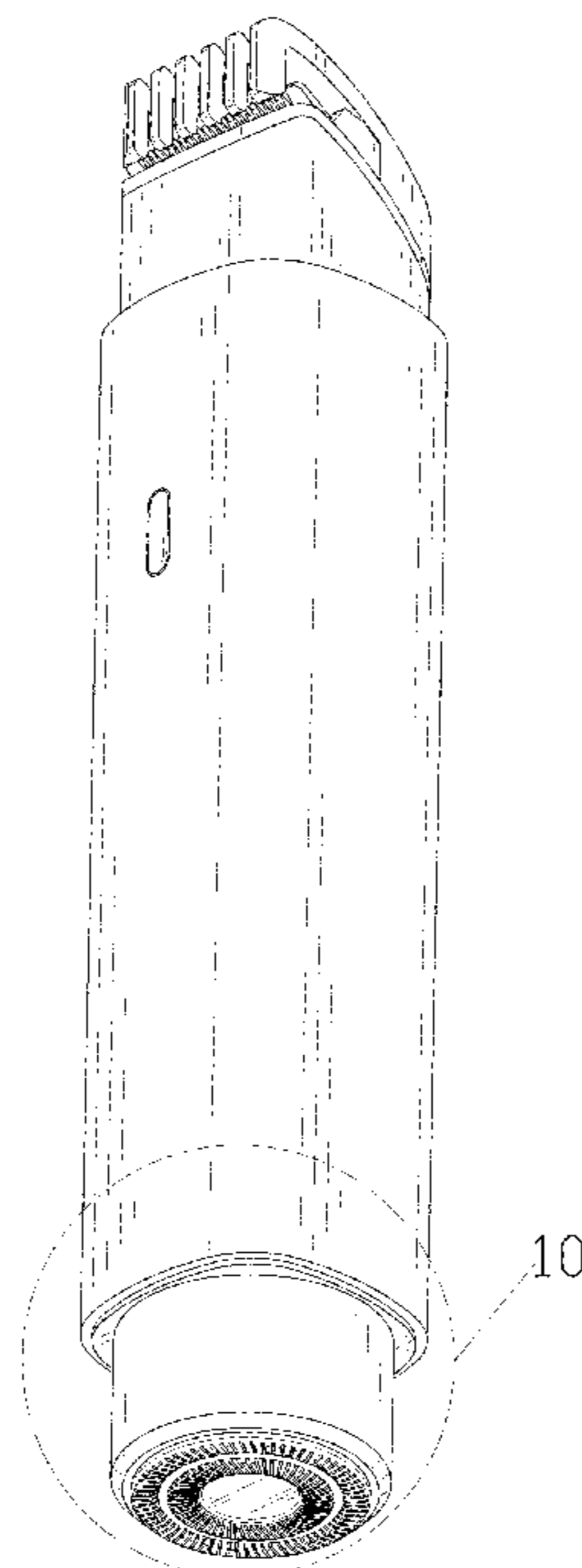

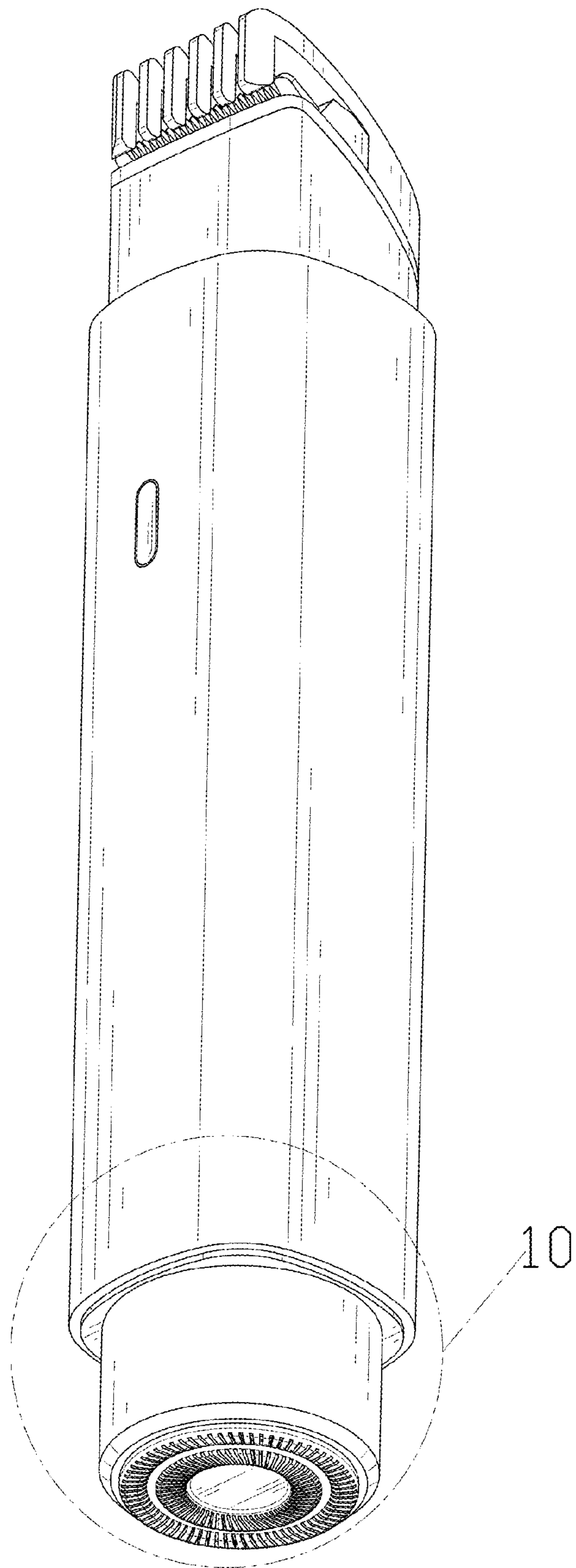

FIG. 1

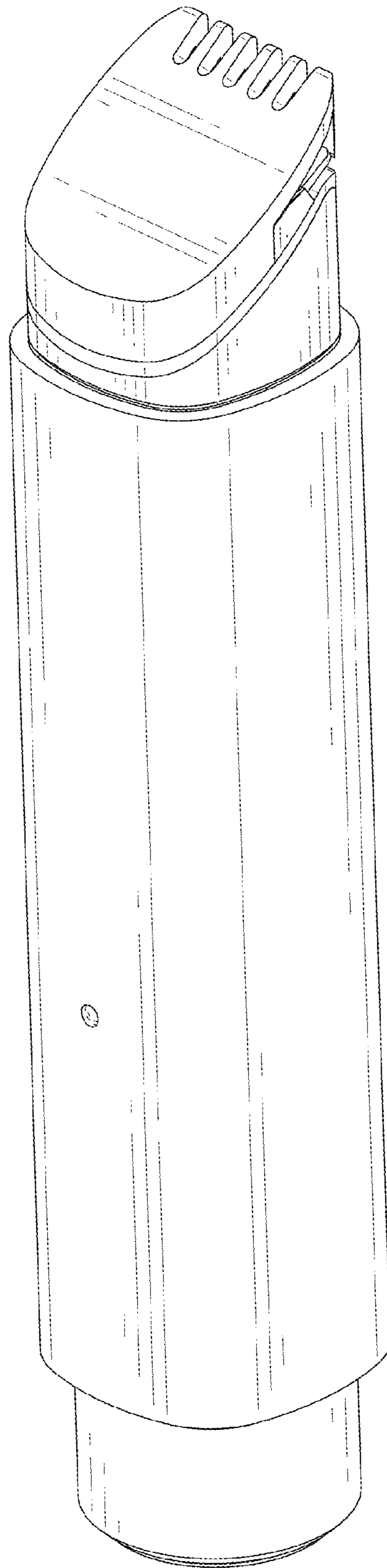

FIG. 2

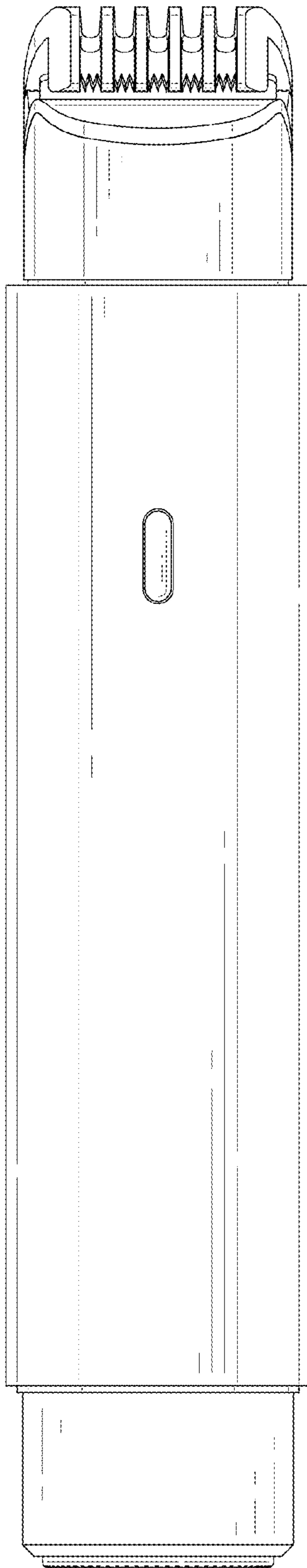

FIG. 3

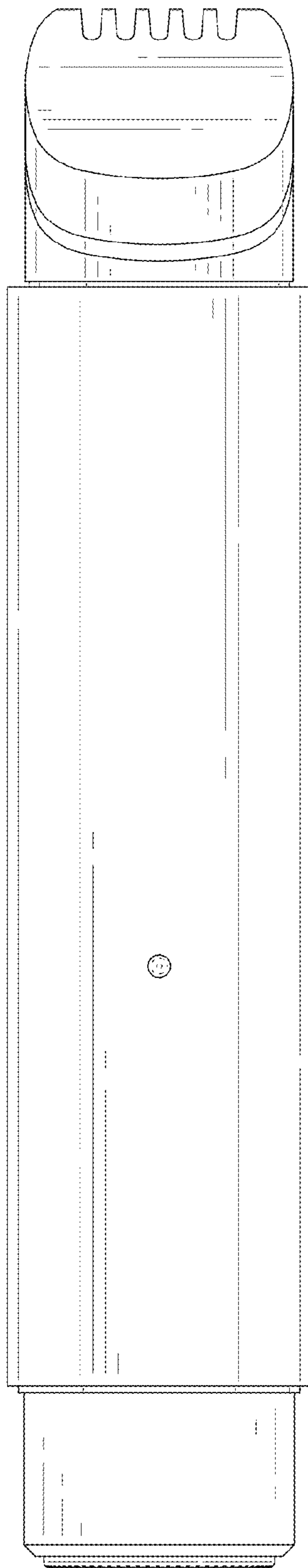

FIG. 4

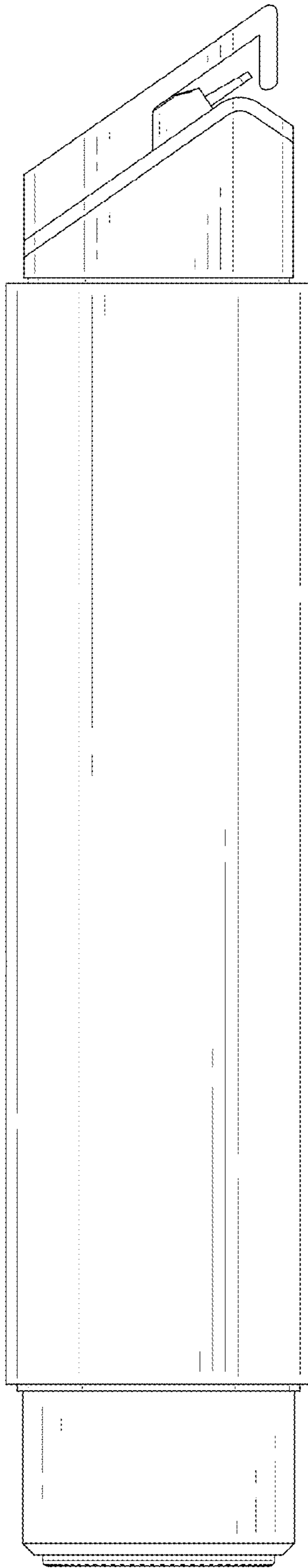

FIG. 5

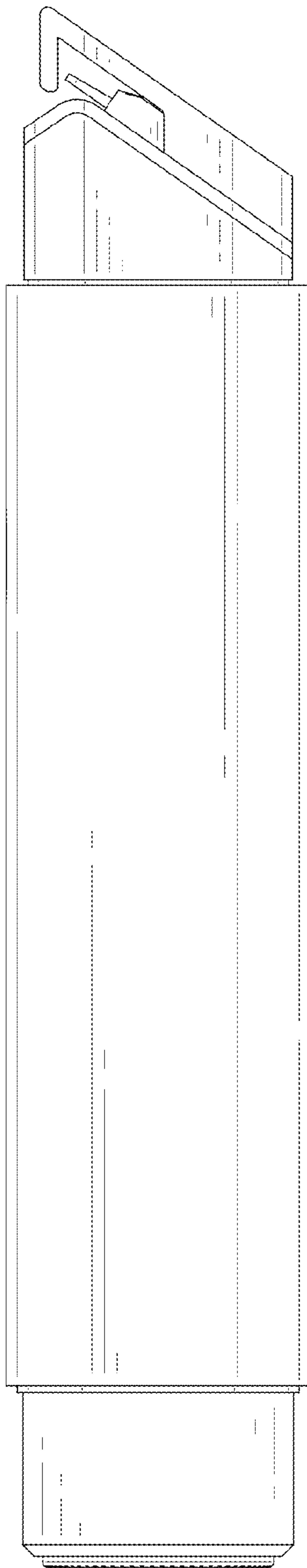

FIG. 6

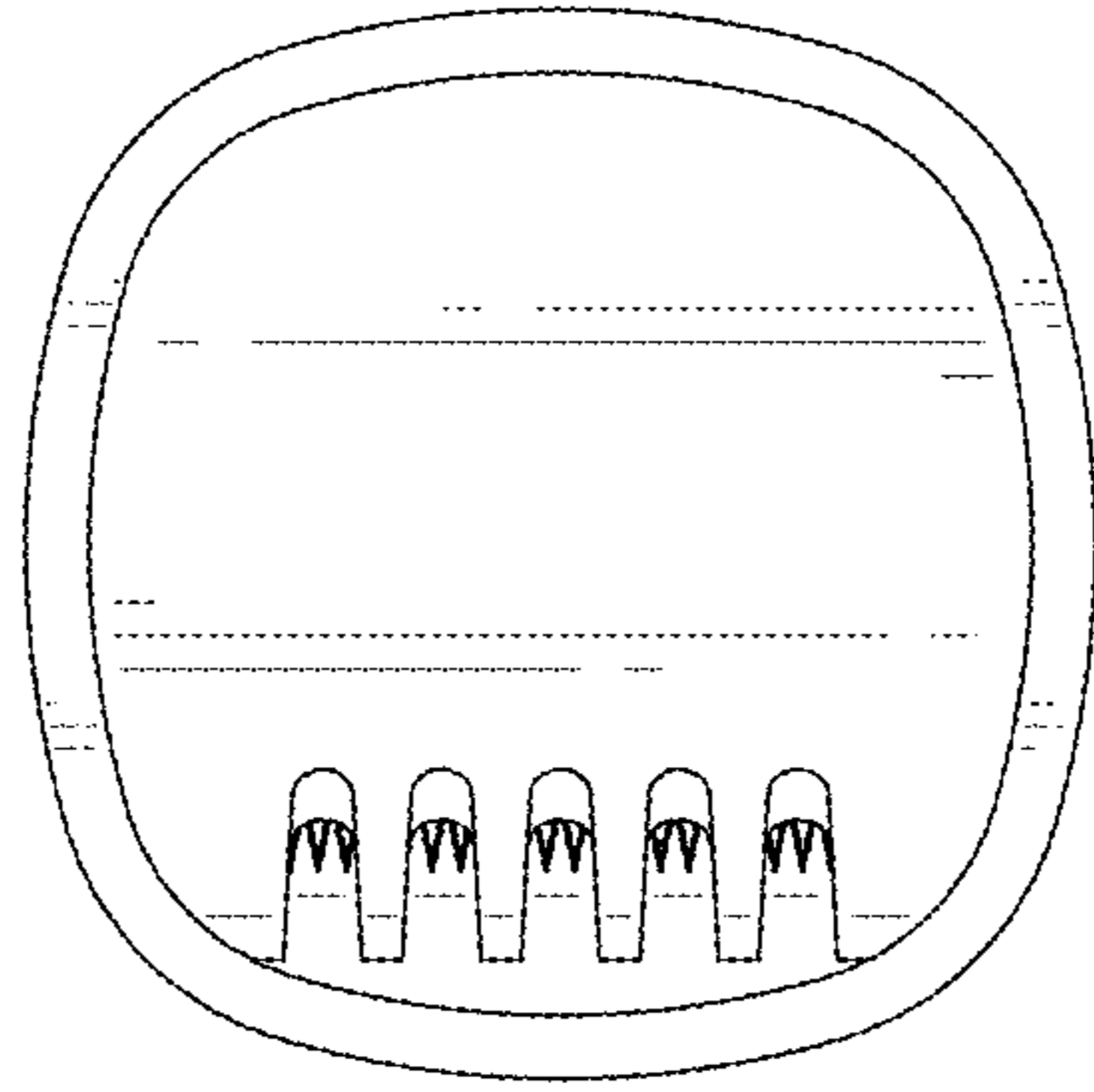

FIG. 7

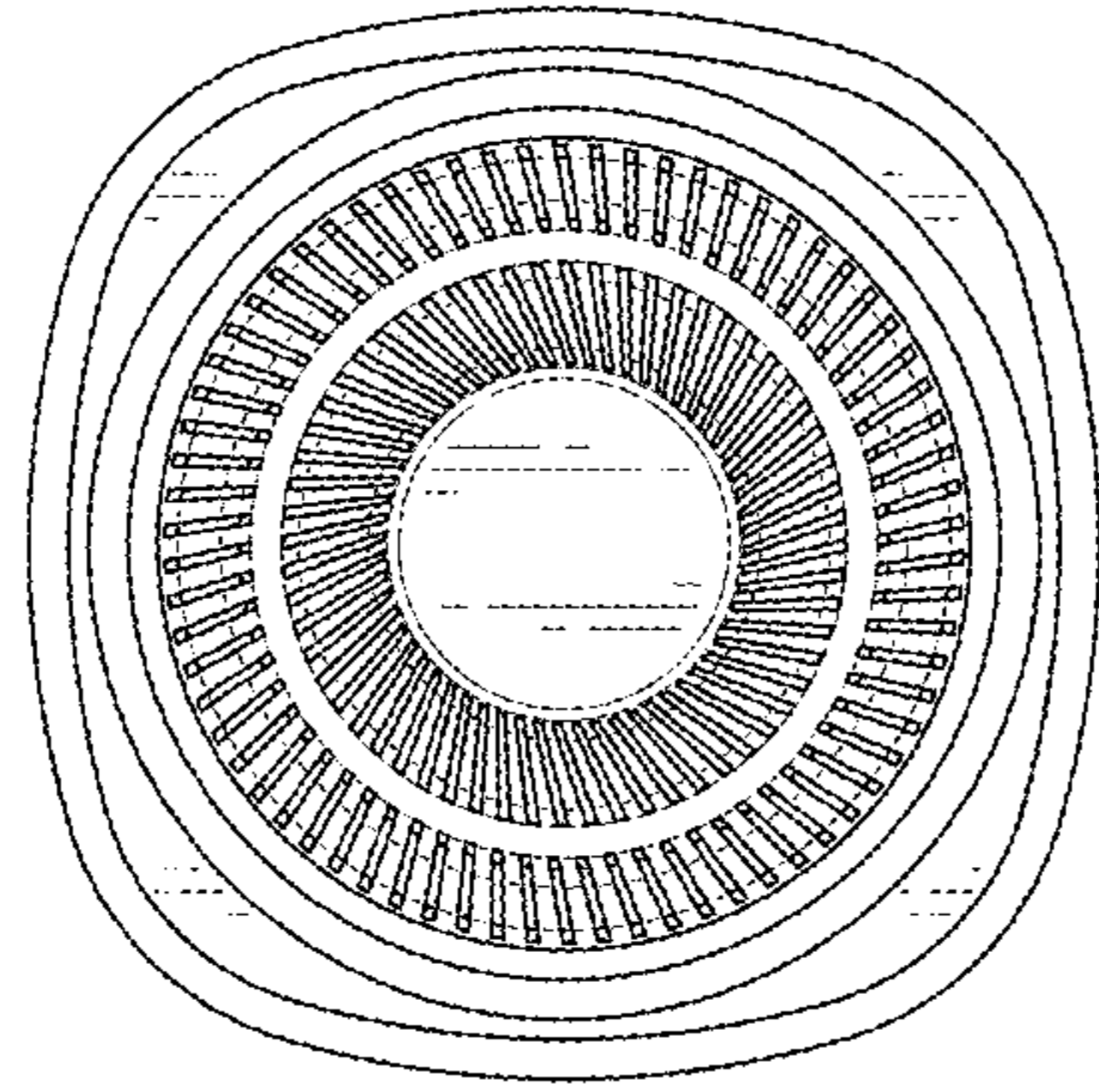

FIG. 8

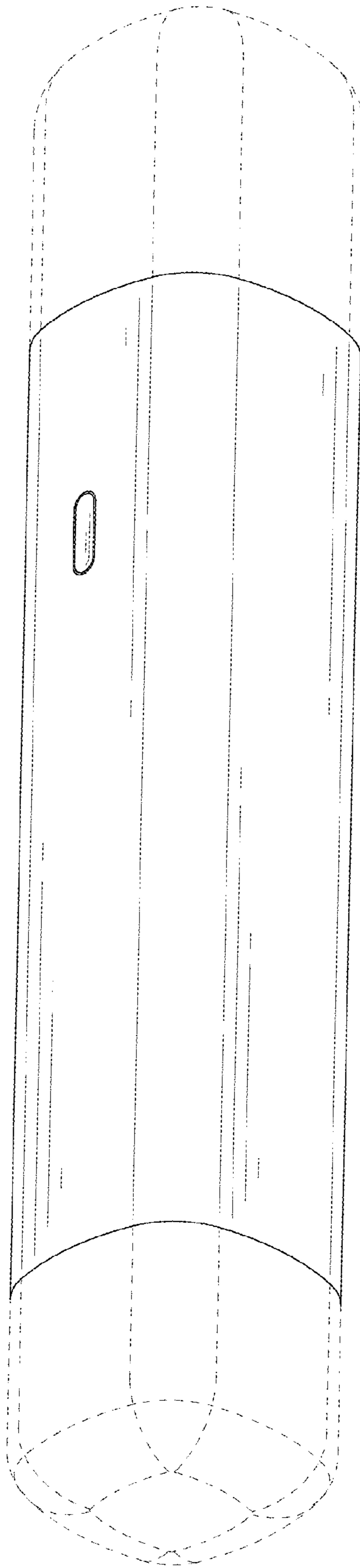

FIG. 9

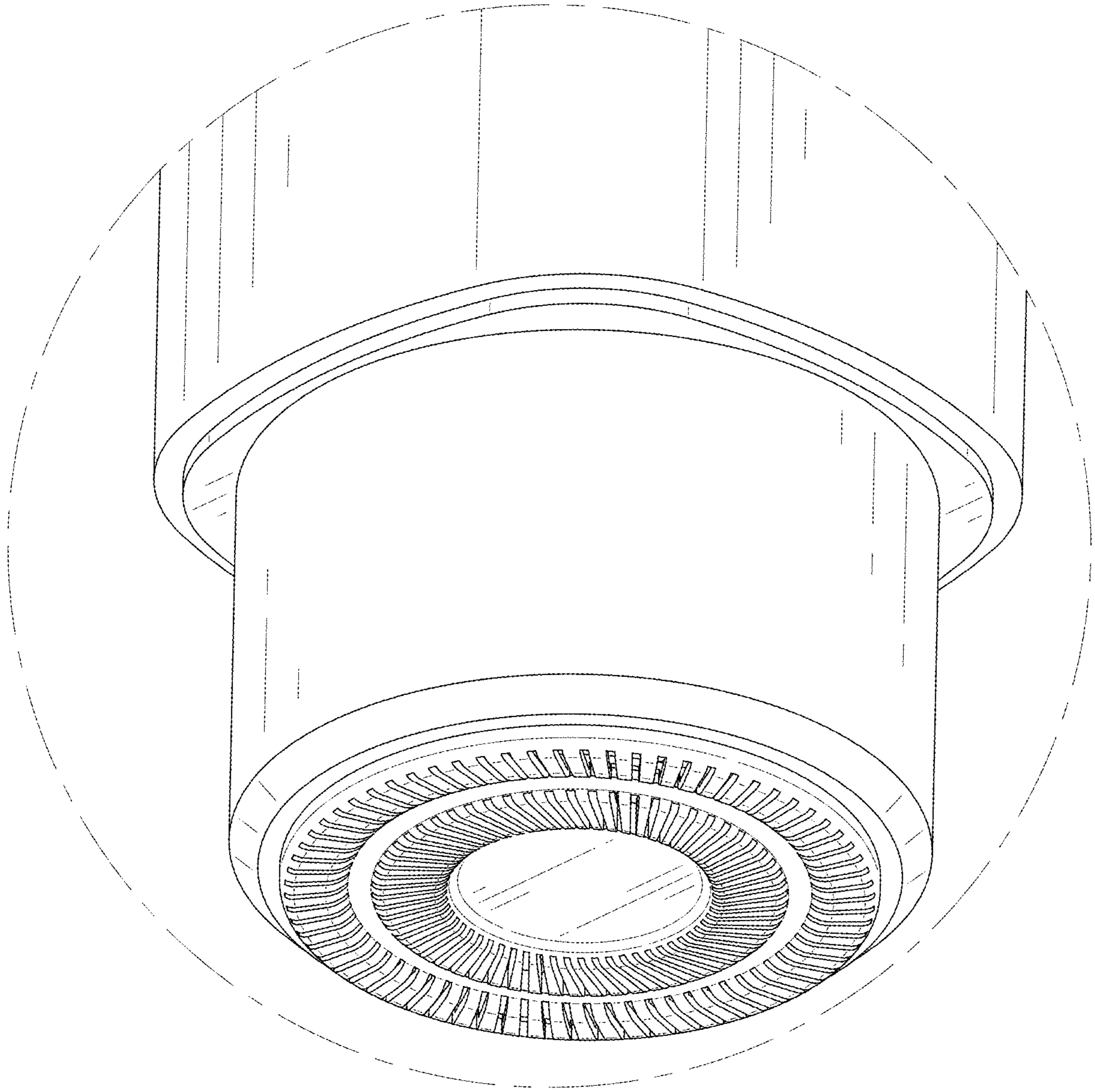

FIG. 10