



US00D951480S

(12) **United States Design Patent**
Wu et al.

(10) **Patent No.:** **US D951,480 S**

(45) **Date of Patent:** **** May 10, 2022**

(54) **TEST DEVICE**

(71) Applicant: **Hangzhou Biotest Biotech Co., LTD.**,
Hangzhou (CN)

(72) Inventors: **John Wu**, San Diego, CA (US); **Liang Hong**, Hangzhou (CN); **Lorraine Cogan**, San Diego, CA (US); **Yangyu Zhu**, San Diego, CA (US); **Shujiang Wu**, Hangzhou (CN)

(73) Assignee: **Hangzhou Biotest Biotech Co., LTD.**,
Hangzhou (CN)

(**) Term: **15 Years**

(21) Appl. No.: **29/699,957**

(22) Filed: **Jul. 30, 2019**

(51) **LOC (13) Cl.** **24-02**

(52) **U.S. Cl.**
USPC **D24/224**

(58) **Field of Classification Search**
USPC D10/46, 216, 223, 224, 225, 226, 227
CPC B01L 2300/0809; B01L 2300/0812; B01L 2300/0816; B01L 2300/0819; B01L 2300/0822; B01L 2300/0825; B01L 2300/0829; B01L 3/5088; B01L 2300/0609; B01L 2300/089; B01L 2300/161; B01L 2400/0415; G01N 27/62; G01N 1/31; G01N 33/54373; G01N 2035/1037; C12M 25/01

See application file for complete search history.

(56) **References Cited**

U.S. PATENT DOCUMENTS

8,691,147 B2 * 4/2014 Leek C12M 25/01
422/63
D907,243 S * 1/2021 Sekiguchi C12M 25/01
D24/225

* cited by examiner

Primary Examiner — Antoine Duval Davis

(74) *Attorney, Agent, or Firm* — NZ Carr Law Office
PLLC

(57) **CLAIM**

The ornamental design for a test device, as shown and described.

DESCRIPTION

FIG. 1 is a top front perspective view of the test device according to the present design;
FIG. 2 is a bottom perspective view of the test device of FIG. 1;
FIG. 3 is a top view of the test device of FIG. 1;
FIG. 4 is a bottom view of the test device of FIG. 1;
FIG. 5 is a left view of the test device of FIG. 1;
FIG. 6 is a back view of the test device of FIG. 1;
FIG. 7 is a front view of the test device of FIG. 1;
FIG. 8 is a top perspective view of the test device of FIG. 1 with a cover; and,
FIG. 9 is a bottom perspective view of the test device of FIG. 1 with a cover.

1 Claim, 6 Drawing Sheets

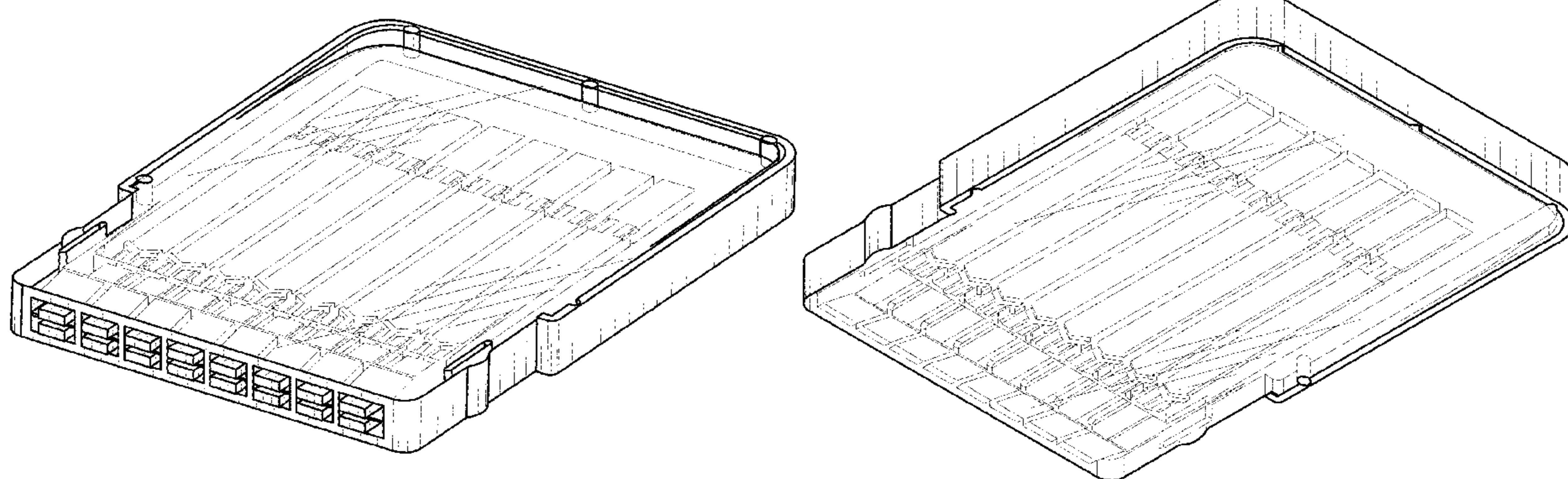

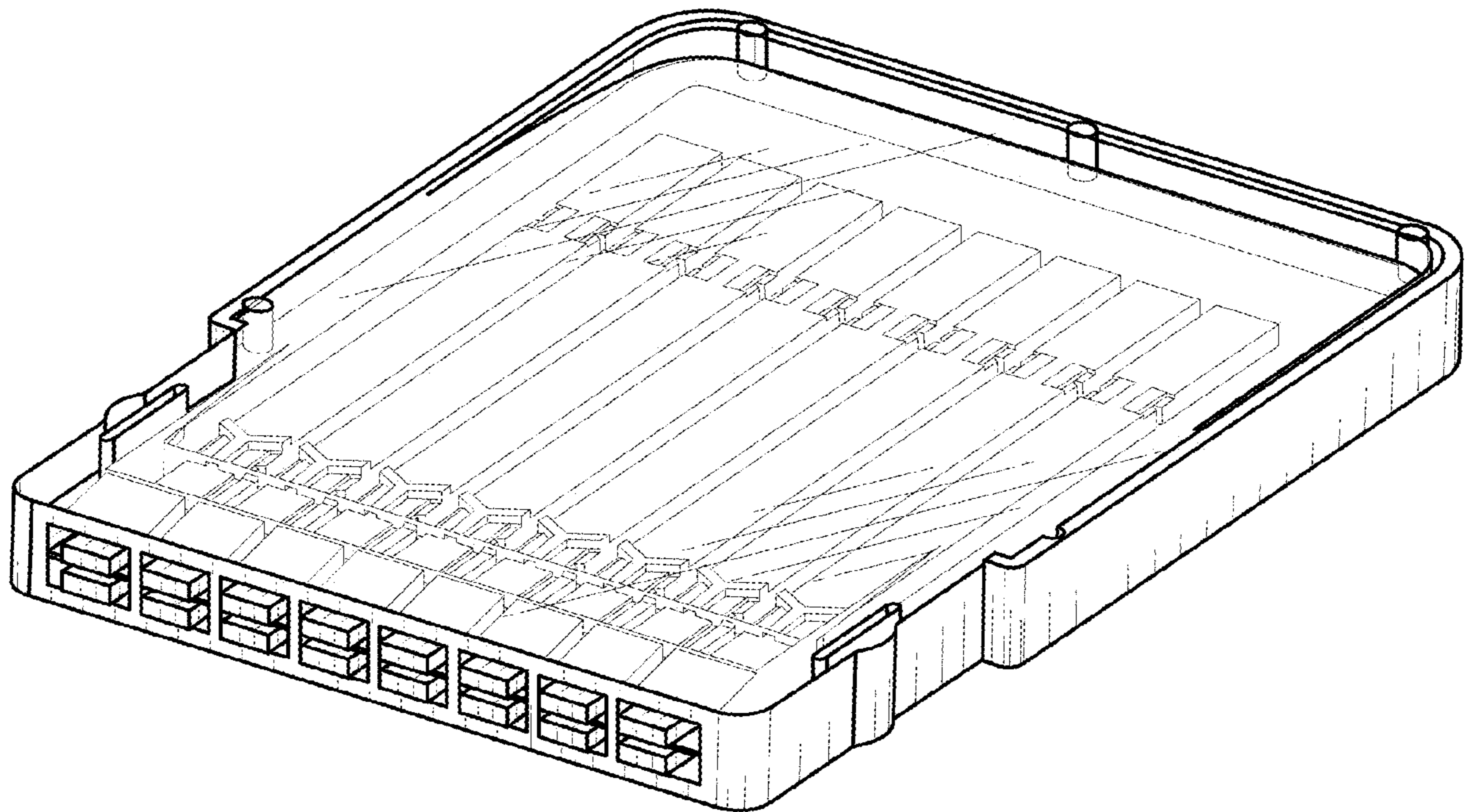

FIG. 1

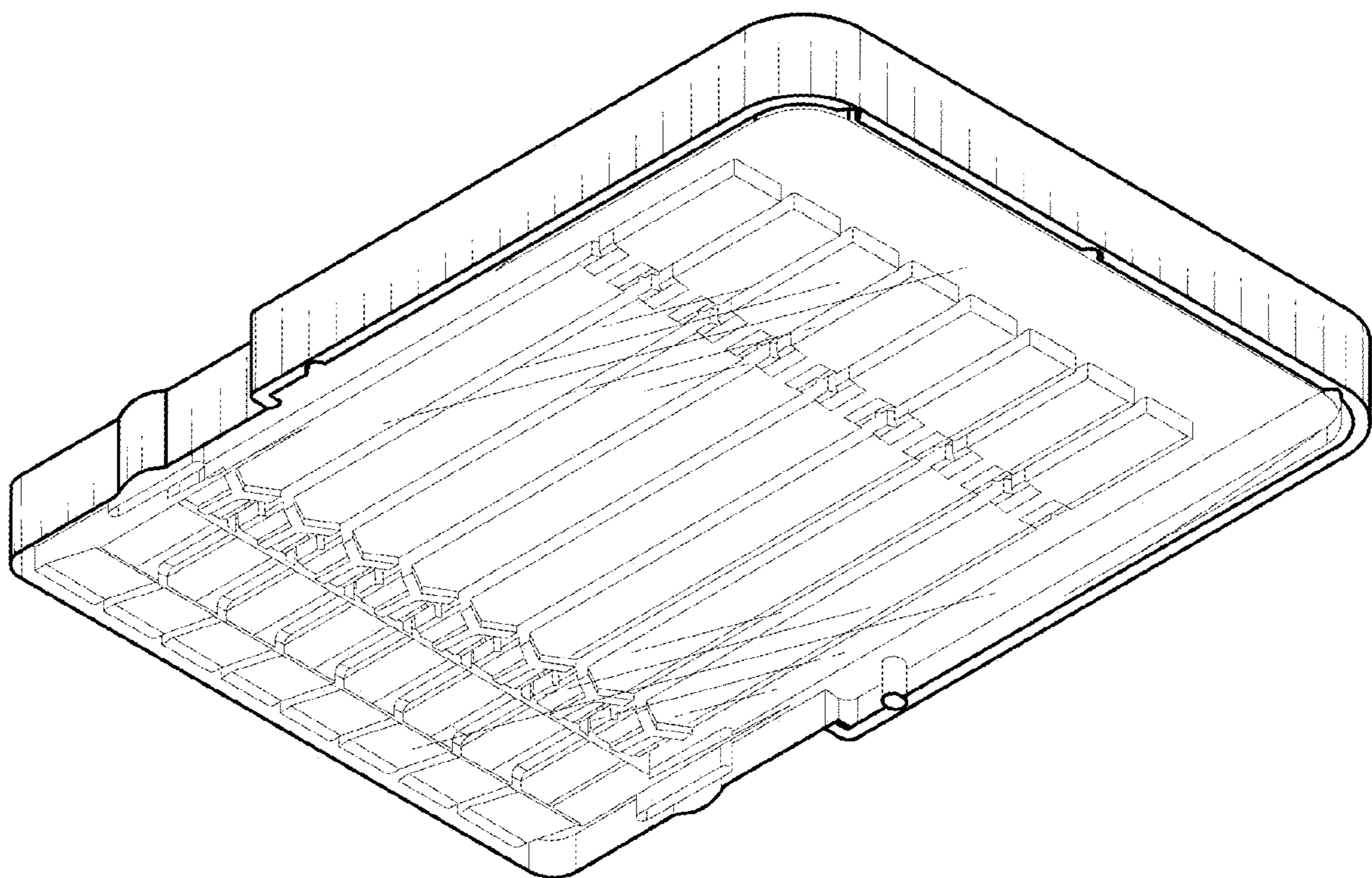

FIG. 2

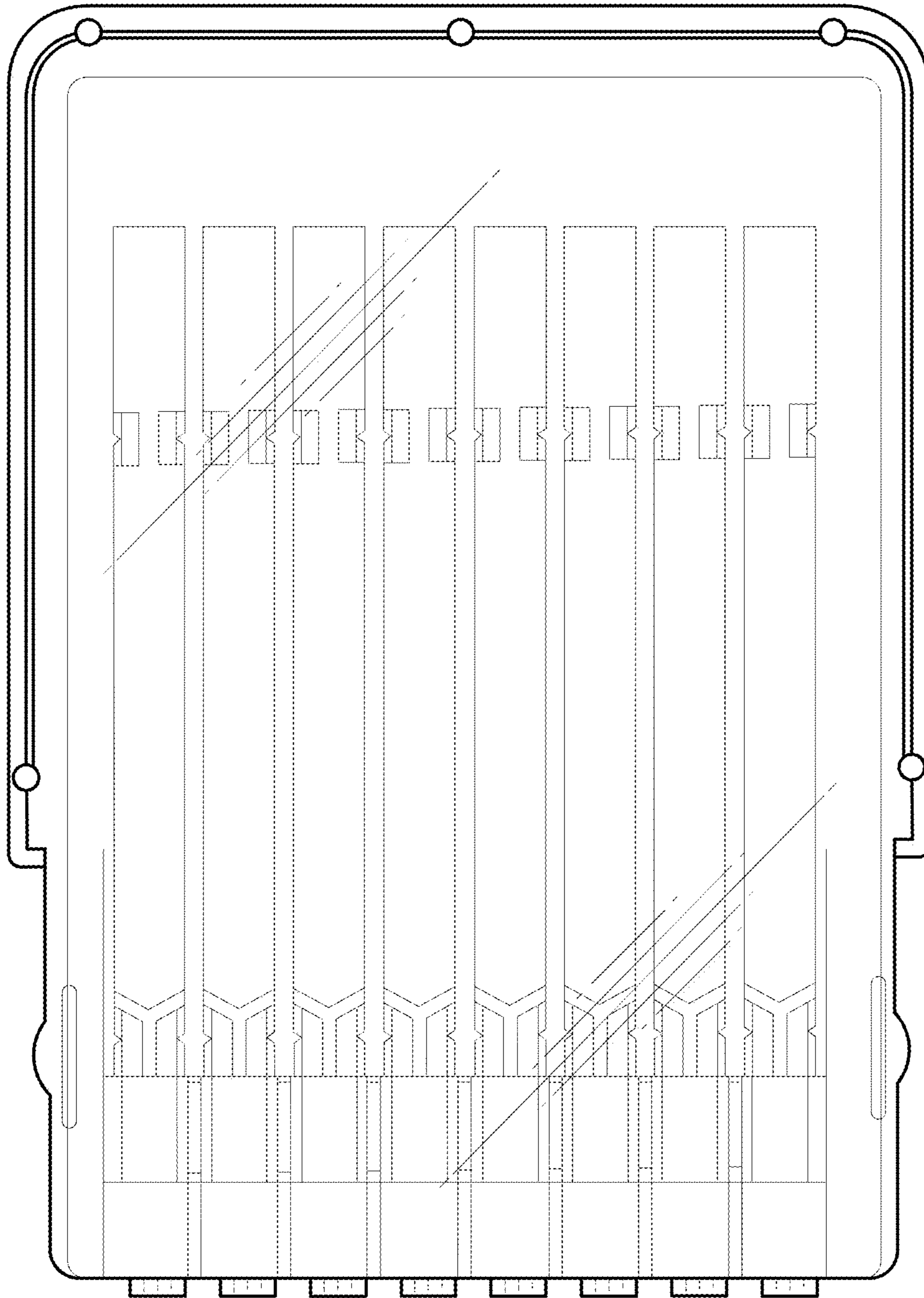

FIG. 3

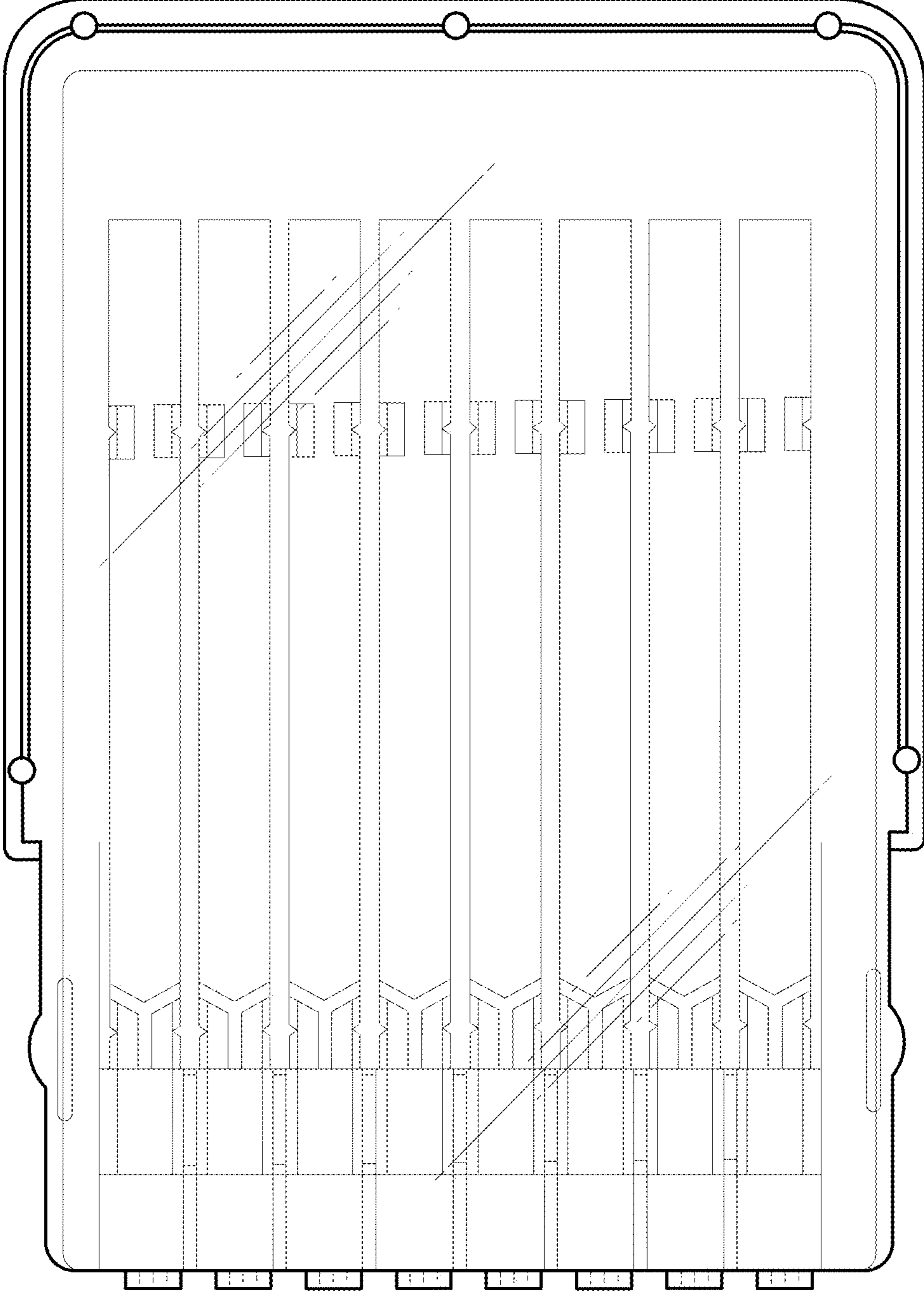

FIG. 4

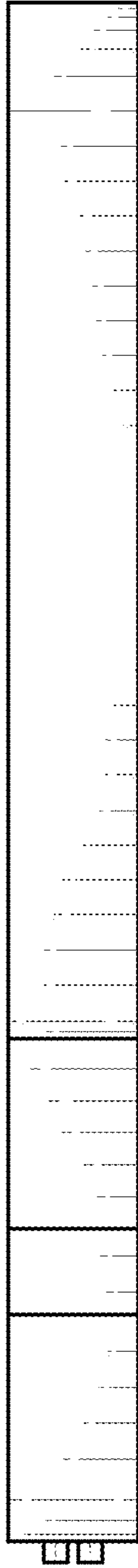

FIG. 5

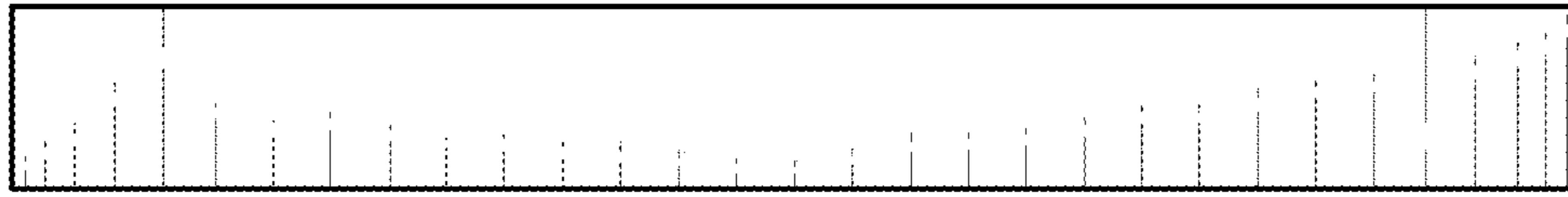

FIG. 6

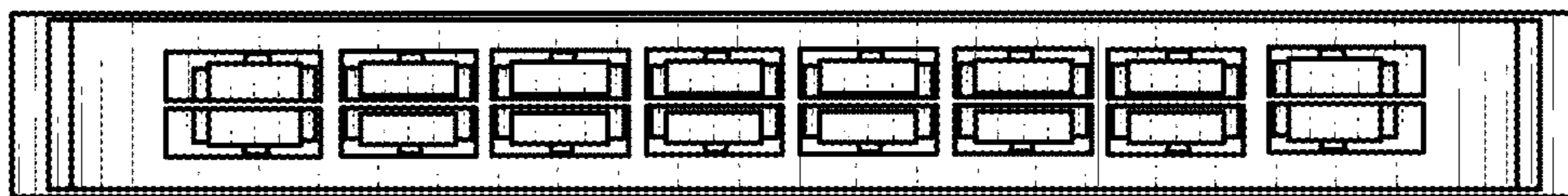

FIG. 7

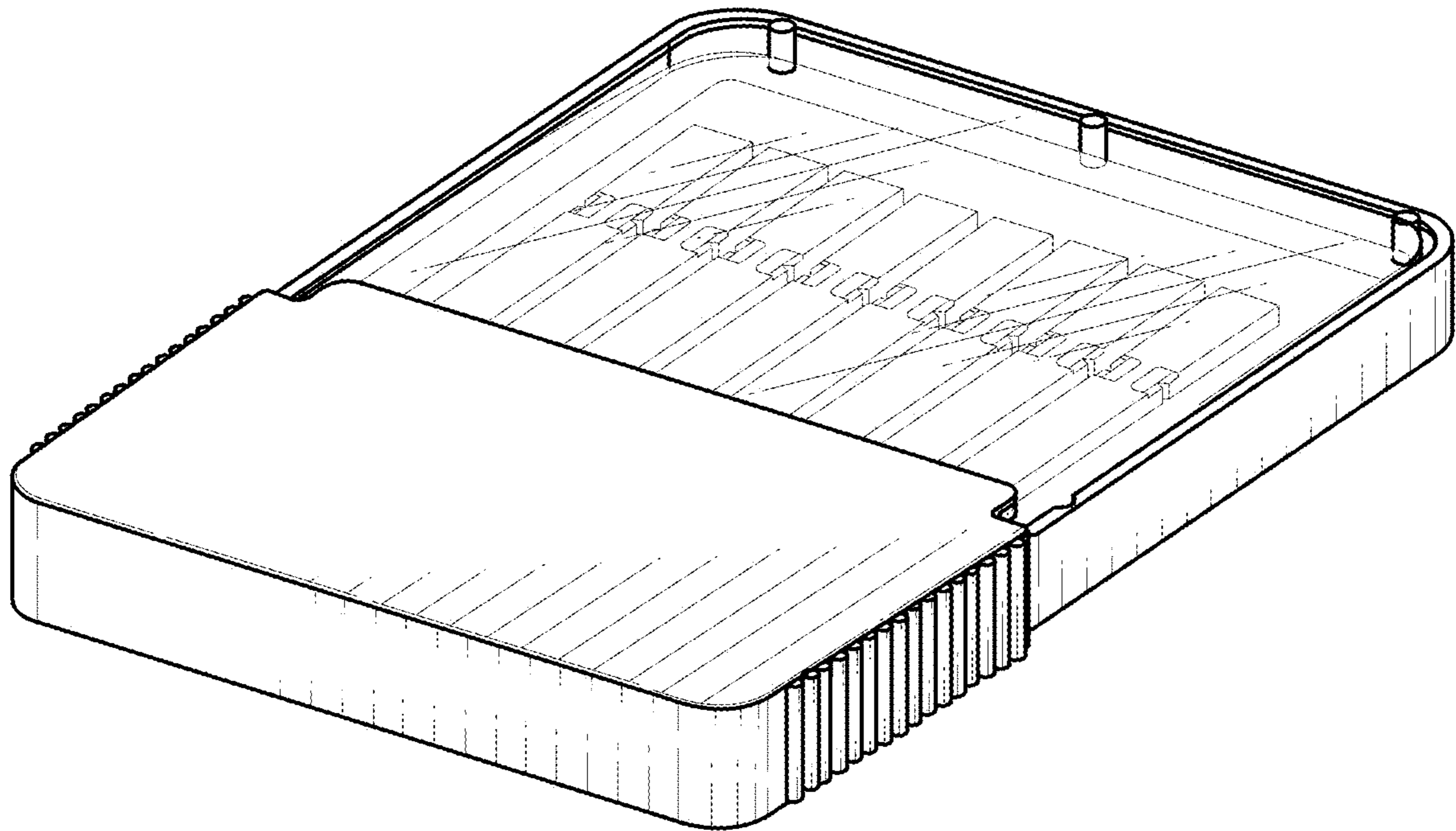

FIG. 8

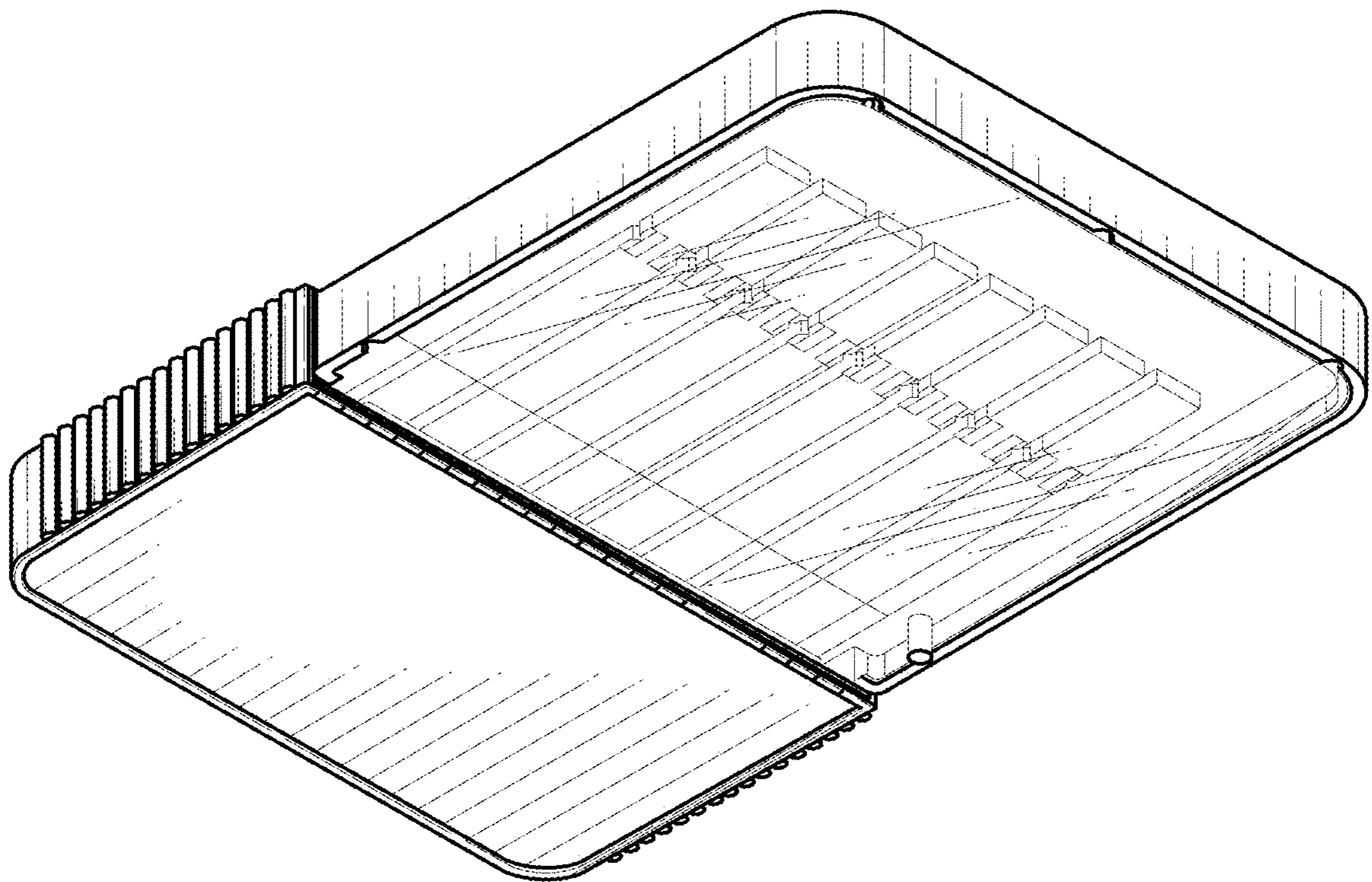

FIG. 9